

# **GASOLINE SILENT INVERTER GENERATOR USER'S MANUAL**

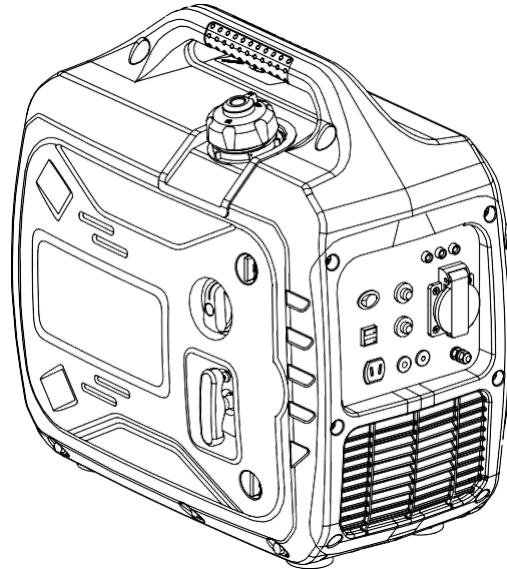



**Please read the manual carefully before use**

# P R E F A C E

This manual describes the operation and maintenance methods of the gasoline generator set. Before operating the generator set, please read and understand this manual carefully to ensure that you can operate it safely and prolong the service life of the generator set.

Due to the continuous improvement and improvement of the product, the company reserves the right to improve and adjust the parameters of the generator set without notifying you. At the same time, due to the improvement of the product, please pay attention to the difference between the generator set described in the manual and your generator set, which is subject to the actual product.

For the personal and property safety of you and others. Please read carefully the safety warnings preceded by the  symbol and the safety notices preceded by the  symbol.

Details are as follows:

 **Danger** Serious injury if instructions are not followed

 **Warning** Risk of serious injury if instructions are not followed

 **Caution** Risk of injury if instructions are not followed

**NOTICE** Your generator set and other property may be damaged if instructions are not followed

# CATALOGUE

SAFTY NOTICE .....	1
CONNECT TO HOME POWER .....	2
APPEARANCE RECOGNITION .....	3
CONTROL FUNCTION .....	5
PREPARATIONS .....	8
OPERATING .....	11
REGULAR MAINTENANCE .....	19
SAFEKEEPING .....	24
TROUBLESHOOTING .....	26
TECHNICAL PARAMETER .....	27
ELECTRICAL WIRING DIAGRAM .....	28

# SAFTY NOTICE

Before operating the generator set, please read and understand this manual carefully. Only familiarity with the safe operation procedures of the generator set can help you avoid accidents.

Keep children and pets away from the operating area.

Do not use indoors



Do not use in wet environments



Do not connect directly to the home circuit

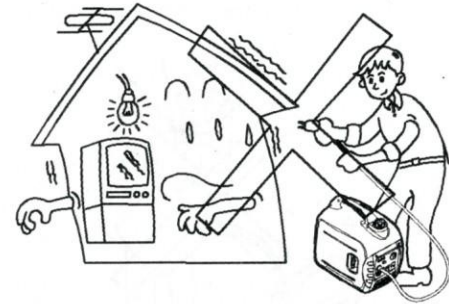

# CONNECT TO HOME POWER

**NOTICE** When connecting the generator to the household power supply for equipment use, it should be done by a professional electrician or someone familiar with electricity.

After connecting the load side to the generator, double check that the electrical connections are safe and secure. Incorrect electrical connections may result in generator damage, burning or fire.

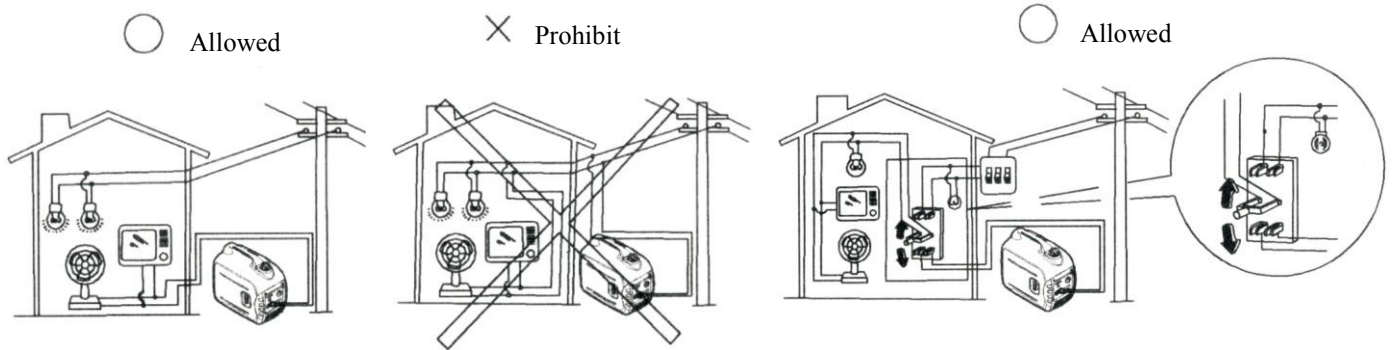

## Generator Grounding

In order to prevent electric shock or electrical misuse due to low-quality electrical appliances, the generator shall be grounded with a good conductor with insulating skin.

**NOTICE** Keep the ventilation holes on the side of the control panel, the side of the tail shutter, and the bottom of the generator clear and free of debris, mud, water, etc. If these vents are blocked, damage to the engine, inverter or motor may occur.

When carrying, storing and using the generator, do not keep it together with other things. If oil leaks, it may damage the generator or your property.

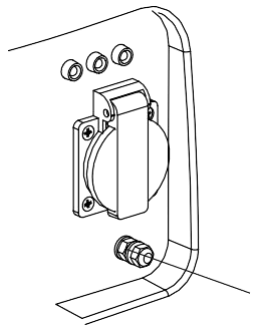

Ground Terminal

## APPEARANCE RECOGNITION

- ① Carrying handle
- ② Fuel tank cap vent knob
- ③ Fuel tank cap
- ④ Control panel
- ⑤ Start handle
- ⑥ Appearance cover (Oil filling)
- ⑦ Rear shutter
- ⑧ Muffler
- ⑨ Maintenance cover for spark plug

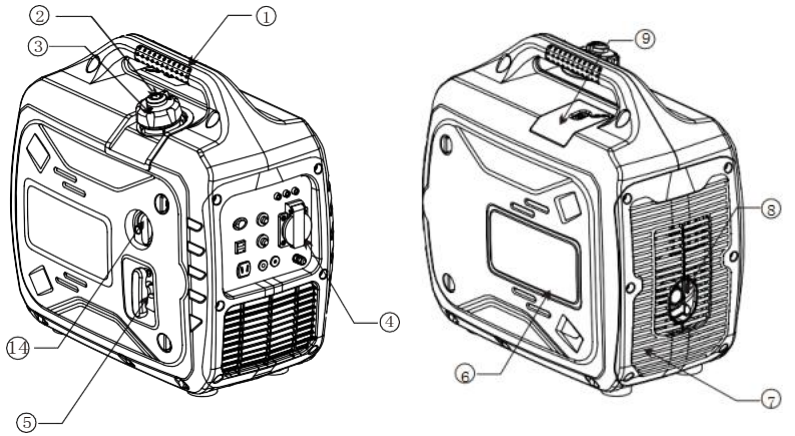

## Control Panel

- ⑩ Oil warning indicator
- ⑪ Fault indicator
- ⑫ Running indicator
- ⑬ Idle switch
- ⑭ Three-in-one combination switch control knob (engine switch /fuel switch /choke switch)
- ⑮ AC socket
- ⑯ USB interface
- ⑰ Ground terminal
- ⑱ Grid connected output socket (with grid connected unit)
- ⑲ DC socket
- ⑳ AC reset
- ㉑ DC reset

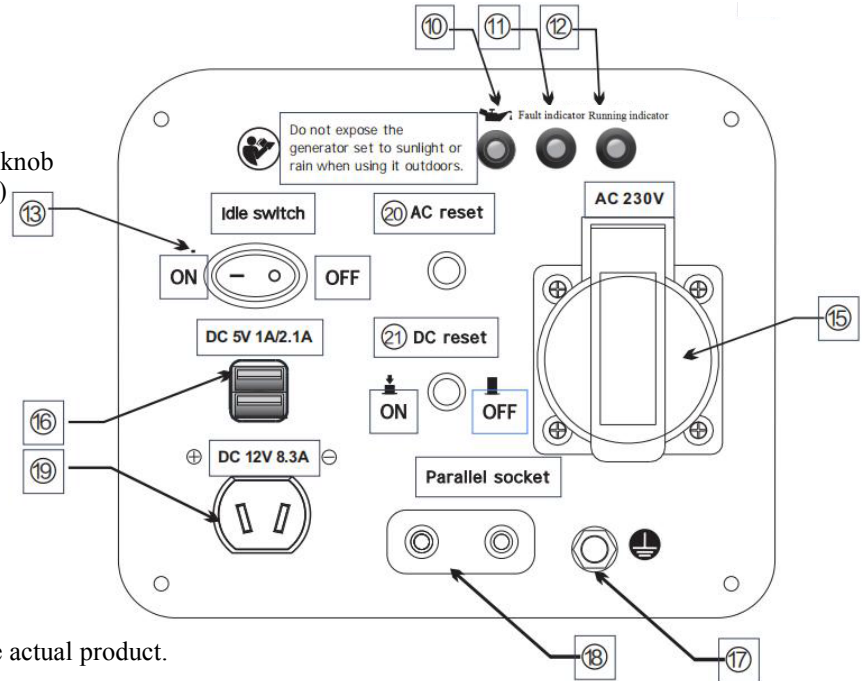

Note: The unit configuration is subject to the actual product.

# CONTROL FUNCTION

## Three-in-one Combination Switch (hereinafter referred to as combination switch)

1. Generator, fuel switch "OFF"  
Ignition circuit is off, fuel switch is off  
The generator will not operate
2. Generator, fuel switch, choke switch "ON"  
The ignition circuit is working, the fuel switch is on, and the choke valve is fully open  
The generator can run normally
3. Generator, fuel switch, choke switch "OFF"  
The ignition circuit is in operation, the fuel switch is open, and the choke is closed  
The generator can start normally  
**Tips:** In the warm-up state, there is no need to turn the knob to the "ON" position.

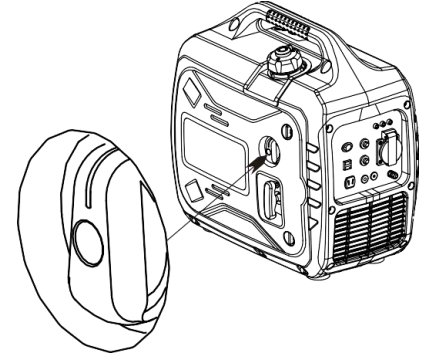

## Oil Alarm Indicator (red light)

When the oil in the crankcase drops below the safety line, the oil protection system will automatically shut down the engine, and the oil warning indicator light will be on; the engine can be restarted only when the oil is filled to the oil level.

**Tips:** If the engine stalls or fails to start, turn the power switch knob to the "ON" position then pull the starter handle. If the oil warning light flashes for a few seconds, the oil volume is low, add oil and restart.





## **Overload Indicator Light (red light)**

When the overload indicator lights up, the generator detects that the output of the connected electrical equipment has been overloaded, causing the frequency converter to overheat, or the AC voltage to rise. At this time, the AC protector works to stop the power generation of the generator to protect the generator and the connected electrical equipment. The AC indicator (green light) is off and the overload indicator (red light) is on, but the engine will not stop.

When the overload indicator is on and the generator has no output, please take the following measures:

1. Turn off the connected electrical equipment and stop the generator
2. Reduce the total power of the connected electrical equipment to within the range of the rated output
3. Check whether the cold air inlet is blocked by foreign objects, and whether the relevant control components are abnormal. If there is any problem, remove it immediately
4. After checking, restart the generator

**Tips:** When using electrical equipment with high starting current (such as compressors, submersible pumps, etc.), the overload indicator light may be on for a few seconds at first, but this is not the fault mentioned above.

## **AC Indicator (green light)**

When the generator starts and outputs normally, the AC indicator light is on.

## **DC Protection**

When the electronic equipment connected to the generator is running, if the current exceeds the rated current, the DC voltage switch automatically turns to the "OFF" position. To operate the generator again, press the DC switch to the "ON" position.

"ON" DC output normally  
"OFF" No DC output

If the DC protection is off, reduce the load on the connected electronics to within the rated output of the generator. If the DC protection is still off, please stop using the electrical equipment directly and consult your dealer.

## Idle Switch

"ON" When the idle switch is in the "ON" position, the device controls the engine speed according to the connected load, so as to obtain better fuel consumption and low noise.

"OFF" When the idle switch is in the "OFF" position, the generator runs at rated speed whether or not a load is connected.

**Tips:** When using the following devices, such as air compressors and submerged water pumps, the idle speed switch must be turned off because a large starting current is required.

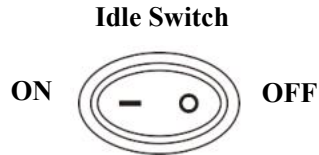

## Fuel Tank Cap Vent Knob

The tank cap has a vent knob to stop the flow of fuel. The vent knob on the fuel tank cap must be in the "ON" position to allow fuel to be injected into the carburetor and the generator to run. When the generator is not in use, turn the vent knob to the "OFF" position to stop the flow of fuel.

## Ground Terminal

When the ground terminal is connected to the ground wire, to prevent electric shock, the generator must be grounded when the electrical equipment is grounded.

## Parallel Operation

The parallel connector is used to connect the special cable of two silent inverter generators running in parallel. Parallel operation requires two silent inverter generators and special cables. Please consult your dealer for operating procedures and related precautions.

# PREPARATIONS



### Fuel

- Fuel is flammable and poisonous. Please read the safety instructions carefully before refueling (page 1)
- Do not overfill the oil, otherwise the oil will overflow when the fuel tank warms up
- After refueling, make sure the fuel tank cap is tightened

## NOTICE

- After refueling, use a clean and soft cloth to dry the residual gasoline in time to avoid damage to the plastic case
- The unleaded gasoline must be used. The leaded gasoline will seriously damage the internal parts of the generator
- Remove the fuel tank cap and add gasoline to the red level indicator line

① Red indicator line

② Fuel level

Recommended fuel: unleaded gasoline

Fuel tank capacity: 4.0 L

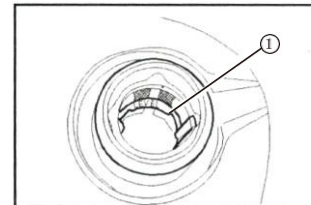
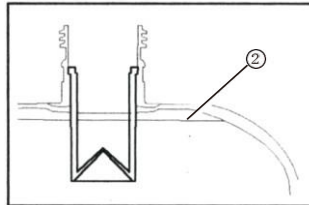

## NOTICE

### Engine oil

This generator is shipped from the factory without oil injection. Do not start the generator until sufficient oil has been filled.

1. Please place the generator on a horizontal plane
2. Loosen knob or screw ①, Remove the exterior cover ②
3. Open the oil filler cap ③
4. Fill in the specified amount of recommended oil and tighten the oil filler cap
5. Reinstall the exterior cover and tighten the screws

Recommended oil: SAE 10W-30

Recommended oil: Grade API, Standard, SE type or higher level

Oil capacity: 0.35

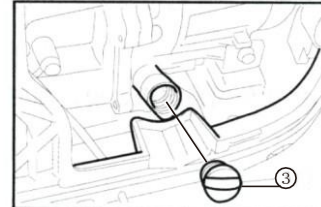
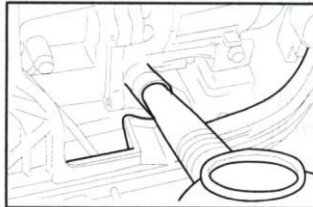
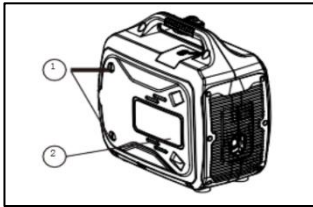

## Checking Before Use

### Warning

If any of the following spare parts don't work properly, Please check and repair before starting the generator. The user should pay attention to the condition of the generators. Even if without using generators, its important parts can suddenly fail.

**Tips:** Before using the generator every time, check before operation

### **Inspection before operation.**

·Fuel · Oil · Abnormal conditions during operation

## OPERATING

### Warning

Don't use this generator in closed space, the gas from generators can cause unconsciousness or even death in a short time. Please use generator in a well-ventilated place.

Don't connect any electrical equipment before starting generator.

### NOTICE

The generator is not injected with oil during transportation. Don't start the generator before inject enough oil.

**Tips:** The generator can operate at rated output load in standard atmospheric conditions.

"Standard atmospheric conditions": Ambient temperature 25℃, Atmospheric pressure 100kPa, Relative humidity 30% .

When the temperature, humidity and altitude exceed the standard atmospheric conditions, the output of the generator will drop.

When used in tight spaces, reduce the load as generator cooling is affected.

## Start of Generator

1. Turn the idle switch to “OFF”①
2. Turn the fuel cap vent knob to “ON”②
3. Rotate the combination switch control to the “Choke” position③

- a. Fuel on
- b. Ignition system on
- c. The choke door is closed, and it is in normal cold working state

Notice: When the warm engine starts, it is not necessary to close the choke door, turn the combination switch to “ON”

4. Gently pull the hand starter until the cable is tightened, and then twitch hard.

**Tips:** When pulling the hand starter, hold the carrying handle tightly to prevent the generator from falling

5. After starting the generator, preheat the generator, and then turn the combination switch knob to the “ON” position ④

**Tips:** When starting the generator, the idle switch is in the “ON” position and the generator cannot be connected to any load

When the ambient temperature is lower than 0 °C (32 °F), the engine speed is 5000r/min, and the warm-up time is 5min;

When the ambient temperature is lower than 5 °C (41 °F), the engine speed is 5000r/min, and the warm-up time is 3min;

After running the above time, the idle switch can work normally when it is in the "ON" position.

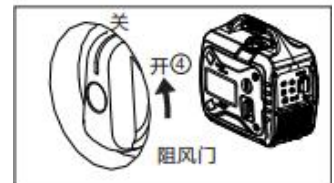
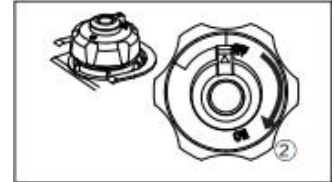
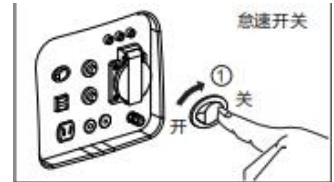

## Alternating Current (AC) Connection

### **Warning**

All electrical equipment should be disconnected before plugging in.

### **NOTICE**

Before connecting to the generator, make sure that all electrical equipment, including leads and plugs, are in good condition.

Confirm that all the loads on the generator are within the rated load range.

Confirm that the load current is within the rated current range of the rated socket.

Notice: Confirm that the generator is grounded. If the electrical equipment, requires grounding, the unit must be grounded.

1. Start the generator
2. Turn idle switch to “ON”
3. Insert the plug into the AC socket
4. Confirm AC indicator lights up
5. Turn on electrical equipment

Notice: Before improving the generator speed, The idle switch must be turned to “OFF”

If the generator supplies power for multiple loads or electrical equipment, please start them from large to small according to the load to load size of each electrical equipment.



## Battery Charging

After starting generator, connect the battery to the generator. Before starting charging, confirm the DC protector is turned on.

1. Start the generator
2. Connect the battery red lead to the battery positive (+) terminal
3. Connect the battery black lead to the battery negative (-) terminal
4. Turn idle to “OFF” to start charging

### NOTICE

Make sure the idle switch is in “OFF” while the battery is charging.

Make sure the red wire of the charger is connected to the positive terminal (+) of the battery, and the black wire is connected to the negative terminal (-). Don't reverse.

The connection between the charger cable and the end of the battery should be reliable to prevent the generator from vibration or other conditions.

Correct operation according to steps of user's Manual.

During charging, if the electric current exceeds the rated electric current, the DC protector will turn off the output. Press the DC protector to “ON” to restart charging, if the DC protector is closed again, stop charging immediately and contact the distributor .

**Tips:** The following instructions in the user's manual indicate that charging is complete.

Measure the specific gravity of the electrolyte to determine if the battery is fully charged. When fully charged, the specific gravity of the electrolyte is between 1.26 and 1.28. It is recommended to check the specific gravity of the electrolyte at least every 1 hour to prevent the battery from being overcharged.

## **Warning**

Don not smoke, connect or disconnect the battery during charging. The sparks can ignite the gas around the battery. Battery electrolyte contains sulfuric acid, which is toxic and presents burn hazard. Please avoid touching skin, eyes and clothes.

### **Treatment methods**

External Contact —— Flush with plenty of water

Misingestion —— Drink plenty of water or milk, and take milk, egg liquid or vegetable oil containing magnesia. Call the hospital immediately.

Stray into eyes —— Flush with water in 15 minutes, and go to the hospital immediately.

Keep the battery beyond the reach of the child.

## **AC Parallel Operation**

Before connecting a kind of equipment to any of generator,make sure that in good conditions and Its electrical rating shouldn't exceed the generator container. Most motor units require more than their rated electric start

When the motor starts, the overload indicator (red light) will illuminate. Normally, the overload indicator (red light) disappears within 4 seconds. If the overload indicator (red light) stays, consult your generator dealer.

When running in parallel, the idle switches of the two generators should be in the same position.

1. The two-day silent variable frequency generator is supplied with its cable kit as instructed to connect the cables for parallel operation.
2. Start the generators in sequence (increasingly), making sure the output indicator (green light) for each generator is illuminated.
3. Plug the device into an AC socket.
4. Start the generator.

The overload indicator (red light) will illuminate when the generator is overloaded or there is a short circuit in the connected equipment. The overload indicator (red light) will stay on, after about 4 seconds, the circuit connecting the device will stop and the output indicator (green light) will disappear. Generator and equipment stop working. check for problem, make sure if connected equipment is shorted or overloaded, correct problem and restart generator.

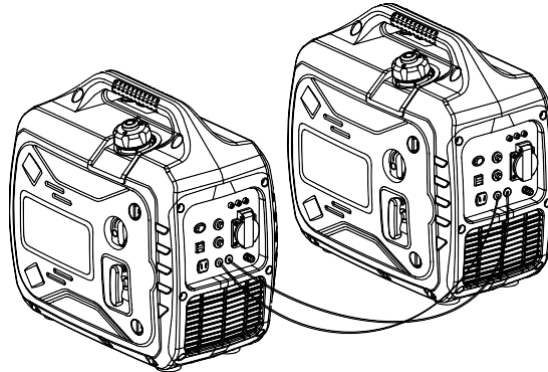

**Tips:**

Make sure its in good working condition. A faulty device or power cord can cause electric shock.

If a device starts to function abnormally, becomes sluggish, or stops suddenly, turn off the power immediately. Disconnect the equipment, make sure if the problem is an appliance, make sure if the rated load capacity of the appliance or generator has been exceeded.

Make sure that the combined work or equipment doesn't exceed the electrical rating of the generator. Don't exceed the maximum limit, and Can be used for up to 30 minutes.

Do not connect in parallel with different types of generators.

Parallel operation, only use the matching parallel run cable kit, then parallel the two silent inverter generator.

Don't connect or unplug parallel running cables while the generator is running.

For single unit operation, the cables for parallel operation must be unplugged.

** Warning**

Massive overload, The overload indicator light (red light) is on continuously and may damage the generator. Overload indicator light (red light), the overload indicator light (red light) is flashing, which may shorten the life of the generator.

The maximum power running time is limited to 30 minutes, and the maximum power for parallel operation: 4.0kVA.

The generator runs continuously, does not exceed the rated power, and the rated power of parallel operation: 3.0kVA

The total power requirements for all connected equipment must be considered. Electrical and power tool manufacturers' lists usually list the wattage ratings of similar models or serial number

## Scope of Application

Before using generator, please confirm the total load is within the rated load range of the generator.

**Tips:** ~ Means not exceed.

When each device is working on its own, it will display the number of applied power.





AC and DC can be used at the same time, but the total power number cannot exceed the rated output power.

When the total power exceeds the rated level, the trouble lamp on.

Don't overload, the total power of the electrical equipment cannot exceed the output power of the generator, overloading will damage the generator.

When use this generator to supply power to precision instruments, electronic controllers, personal computers, electronic computers etc, please keep a sufficient distance between the equipment and the generator to prevent electromagnetic interference from the generator. It also ensures that the generator is not disturbed by other surrounding electronic facilities.

If using this generator to power medical equipment, it is recommended to consult the equipment manufacturer, professional or hospital firstly.

AC				DC 
Power Factor	1	0.8-0.95	0.4-0.75 效率0.85	
	~1,600W	~1,280W	~544W	Rated voltage 额定电压 12v Rated current 额定电流 8.3A

发电机额定输出		1,600VA
利用率	功率因数	
AC 交流	1.0	~1,600W
	0.8	~1,280W
DC 直流	---	100W (12V/8.3A)

## REGULAR MAINTENANCE

The user should operate the machine safely. Periodic inspection, adjustment and lubrication can ensure the generator works more safely and efficiently. The following are important inspection items for generators.



### Warning

If you are not familiar with maintenance work, please leave it to the dealer to serve you .  
Turn off the generator before maintenance.

### NOTICE

Only the designated genuine components can be used for replacement, please contact the dealer for specific precautions

Items	Routine inspection	Check before use (Every day)	Every 6 months or 100 hours	12th month or 300 hours
Spark plug	Check condition, clean or replace if necessary		○	
Fuel	Check oil level for leaks	○		
Tubing	Check the tubing for cracks or damage and replace if necessary	○		
Oil	Check oil level, replacement	○	○ (*1)	
Air filter	Check status, clean		○ (*2)	
Muffler grille	Check condition, clean or replace if necessary		○	
Spark collector	Check condition, clean or replace if necessary		○	
Fuel filter	Clean or replace as necessary			○
Crankcase breather	Check for cracks or breakage and replace if necessary			○
Cylinder head	Clean up carbon deposits if necessary, operate multiple times			★
Valve clearance	Check and adjust after generator cools down			★
Fittings/Retainers	Check all fittings/fixtures and adjust if necessary			★

\*1 First oil change in the previous month or after 20 hours of operation, \*2 The air filter should be cleaned more frequently when it is used in damp or dusty places

★ These items should be maintained by an authorized distributor.

## Spark Plug Inspection

Spark plug are an important spare part of generator and must be checked regularly.

1. Remove the spark plug maintenance cover and spark plug cover, pass the socket through the lid into the hole.
2. Insert the screwdriver into the socket, and rotate counterclockwise to remove the spark plug.
3. Check for fading and remove carbon deposits, the porcelain core around the center electrode of the spark plug should be a medium-light brown.
4. Check spark plug type and space.

**Tips:** The spark plug gap should be measured with a wire thickness gauge and adjusted if necessary.

5. Install spark plugs.

Spark plug torque:  $20.0\text{N}\cdot\text{m}$  ( $2.0\text{kgf}\cdot\text{m}$ ,  $14.8\text{ lbf}\cdot\text{ft}$ )

**Tips:** If without torque wrench when installing spark plug, a better way hand screw 1/4-1/2 turn. The spark plug should be tightened to the specified torque as soon as possible.

6. Reinstall spark plug cap and cover.

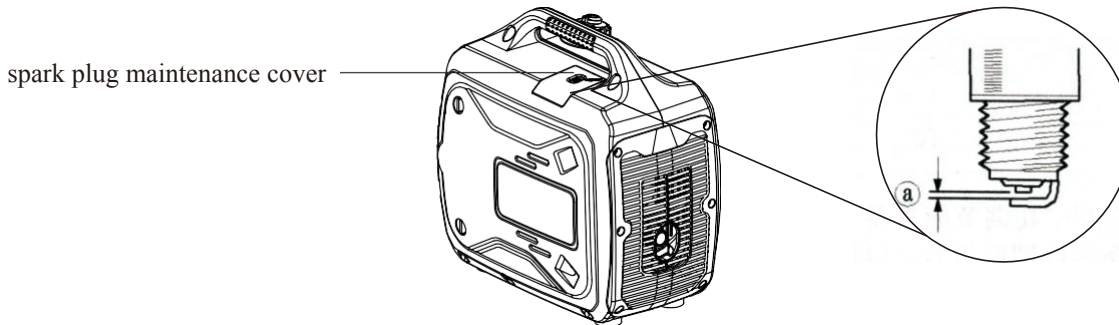

## Adjust the Carburetor

Carburetor is the important parts of generator. Its adjustment should have professional knowledge, professional materials and equipment to be carried out by the dealer to ensure correct adjustment.

## Oil Change



Don't drain the oil immediately after turning off the generator. The temperature of the oil is very high, so pay attention to avoid burning yourself during operation.

1. Place the generator on a level surface and start the generator for a few minutes, increase its temperature, then stop the generator. Turn the three-in-one combination control switch knob and fuel tank cap ventilation knob to the "off" state.
2. Remove the screws①, remove the exterior cover②
3. Remove the oil cover③
4. Place the oil basin under the generator, tilt the generator, and quickly pour out the oil.
5. Put the generator back on a level surface.

### NOTICE

Don't tilt the machine when adding oil, to avoid adding too much oil to damage the power.

6. Refill the oil to the proper position.
7. Wipe the lid clean to remove spilled oil.

### NOTICE

Don't allow foreign matter to enter the generator box.

8. Tighten the oil dipstick.
9. Cover the exterior cover and tighten the screws

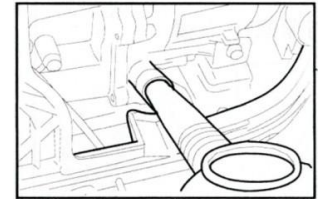
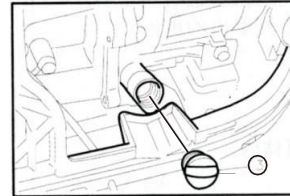
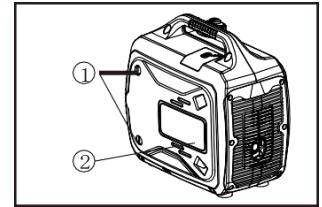



## Air Filter

1. Remove the screws, Remove the exterior cover.
2. Remove the screws③, Remove the air filter cover④.
3. Remove the foam filter①.
4. Clean foam filter with solvent and dry.
5. Add oil to the foam filter and squeeze out excess oil, the foam filter should be wet but not dripping.

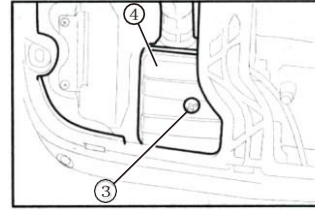

### NOTICE

Don't twist the foam filter hard to avoid damage.

6. Put the foam filter in the air filter.

### Tips

Make sure the surface of the foam filter element is in close contact with the air filter, don't leave any gaps for air leakage.

When the air filter is not installed, don't start the generator, Because of the production of excessive toxic gas and the use of oil cylinder wear .

7. Reinstall the air filter cover in its original position and tighten the screws.
8. Reinstall the appearance cover and tighten the screws.

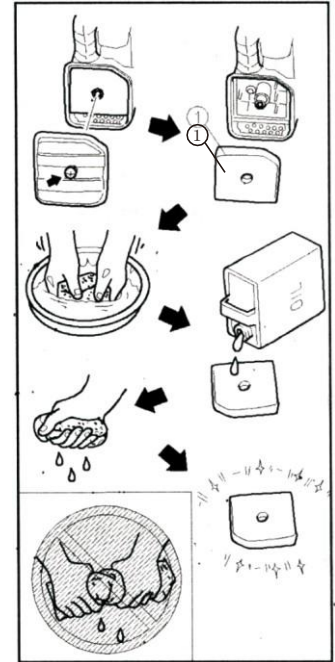

## Muffler Grille and Spark Collector

### Warning

After the generator is running, the generator and muffler will become very hot. During inspection and maintenance, do not let your skin and clothes directly touch the generator and muffler.

1. Remove the screws①, Remove the rear shutter②
2. Loosen the bolt③, Remove the muffler cover④, muffler grille⑤、 spark collector⑥
3. Use a wire brush to remove carbon deposits on the muffler grille and spark collector.  
Gently clean with wire, Avoid damaging or scratching the muffler grille and spark collector.
4. Check the muffler grille and spark collector if damaged, replace immediately.
5. Reinstall the spark collector.

### Tips

Guaranteed bump of spark collector ⑦Small hole with muffler pipe ⑧on a straight line.

6. Replacing the muffler grille and muffler cover.
7. Install the tail shutter and tighten the screws.

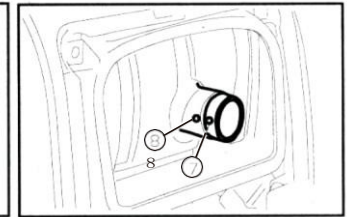
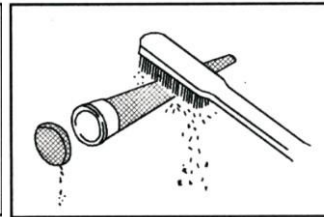
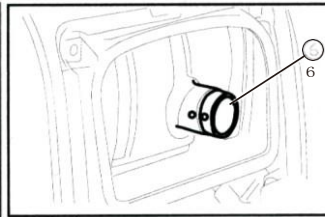
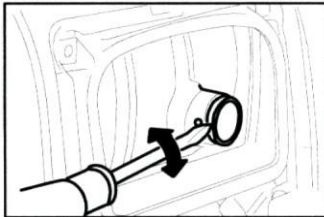
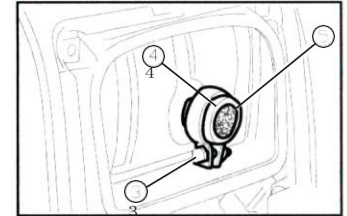
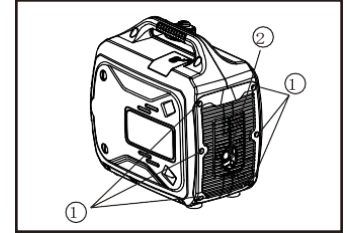

# SAFEKEEPING

**If you plan to use the generator for a long time, in order to prevent aging, you need to take some keeping measures. Evacuate the fuel.**

1. Turn the three-in-one combination control switch knob to “OFF”.
2. Open the fuel tank cover, take out the filter. Extract all the fuel in the fuel tank to the dedicated fuel tank, and then replace the fuel tank cap.



**Warning**

Fuel is highly volatile and toxic, please read "Safety Instructions" carefully (see page 1).

**NOTICE**

Use a clean and soft cloth in time to wipe off the out flowing fuel; prevent damage to the plastic cover;

3. Start the generator, after about 20 minutes, the fuel is completely used up and shut down.

**Tips:** Don't connect any electrical equipment during storage.

Generator run time, depending on remaining fuel in tank.

4. Remove the screws, Remove the exterior cover.
5. Loosen the oil drain bolt on the carburetor and put the fuel in the carburetor into the special fuel tank.
6. Turn the three-in-one combination control switch to “OFF”
7. Tighten the oil drain bolt.
8. Install the exterior cover and tighten the screws.
9. After the generator has cooled down completely, close the gas cap vent knob.

## Engine

Follow the steps below, Protection box、Corrosion-prone parts such as piston rings.

1. Remove the spark plug, Pour in a spoonful of SAE10W30 oil, Reinstall the spark plug, pull the pull starter (Close the combination switch) several minutes, lubricate the cylinder with oil.
2. Pull the pull starter until you feel the tension (Prevent rusting of cylinder block and valves).
3. Wipe the surface of the unit, rotate the unit in a ventilated and dry place, and cover it with a cover.

## Fuel Tank Filter

Never use gasoline where there is smoke or flames

1. Remove the fuel tank cap and the fuel tank filter
2. Cleaning the fuel tank filter with gasoline
3. Wipe the filter screen dry and put it back into the fuel tank
4. Reinstall the fuel tank cap

Note that the fuel tank cap must be tightened

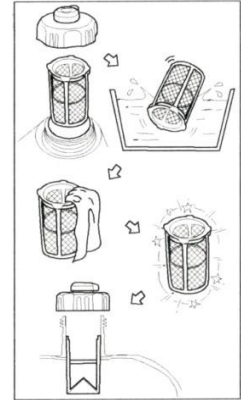

## Fuel Filter

1. Remove the screw ①, remove the exterior cover ②, and drain the fuel in the fuel tank ③
2. Hold the clamp ④, move the clamp down, and then pull down the oil pipe ⑤ connected to the fuel tank
3. Take out the fuel filter ⑥
4. Clean the fuel filter with gasoline
5. Dry the fuel filter and put it back in the tank
6. Reinstall the fuel pipe, install the clamp, open the fuel valve, and check for leakage
7. Reinstall the appearance cover

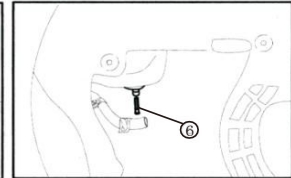
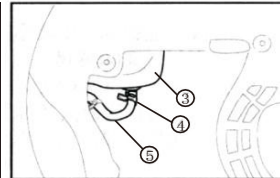
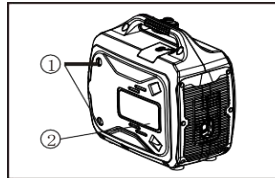

# TROUBLESHOOTING

## **Generator fails to start**

### **1. Fuel system**

No gasoline in combustion chamber

There is no fuel in the tank ——Refuel;

There is fuel in the tank ——Verify that the tank cap vent knob is open;

Fuel filter clogged ——Clean the fuel filter;

Carburetor clogged ——Clean the carburetor.

### **2. Oil system**

Low oil

The oil level is too low ——Add oil.

### **3. Electrical System**

The combination switch is turned to "Choke", and the recoil starter is normal ——The spark plug has no ignition

The spark plug has carbon deposits or is wet ——Clean the spark plug and dry the spark plug

Ignition System Problems ——Please contact the dealer

### **No voltage output of the generator**

The safety device (DC protector) is in the "off" position ——Press the DC protector to make it in the "ON" position.

The AC indicator light (green light) goes out ——Stop the generator and restart it.

# TECHNICAL PARAMETER

Generator	Unit Model		YH2200i
	Type		Silent inverter generator
	Rated Frequency		50/60 Hz
	Rated Voltage		120/220/230/240V
	Max Output		2.0 KW
	Rated Output		1.8 KW
	Power Factor		1.0
	THD waveform distortion rate		≤3%
	Noise at 7m		68 dB
	DC Output		12V/8.3A
	USB Output		5V/1A
	Overload Protection	DC	Fuseless Overcurrent Protector
AC		Program Control of AC Overcurrent Protection	
Engine	Engine Model		YH148F
	Engine Type		Single Cylinder, 4 Strokes, Air Force Cooling
	Continuous Running Time		4 h
	Starting Type		Recoil
	Displacement		79.7cc
	Fuel Type / Tank Volume		Unleaded gasoline / 4.0 L
	Oil Capacity		350 mL
Size	Length*width*height		460×290×455 mm
	Net Weight		18 kg

# ELECTRICAL WIRING DIAGRAM

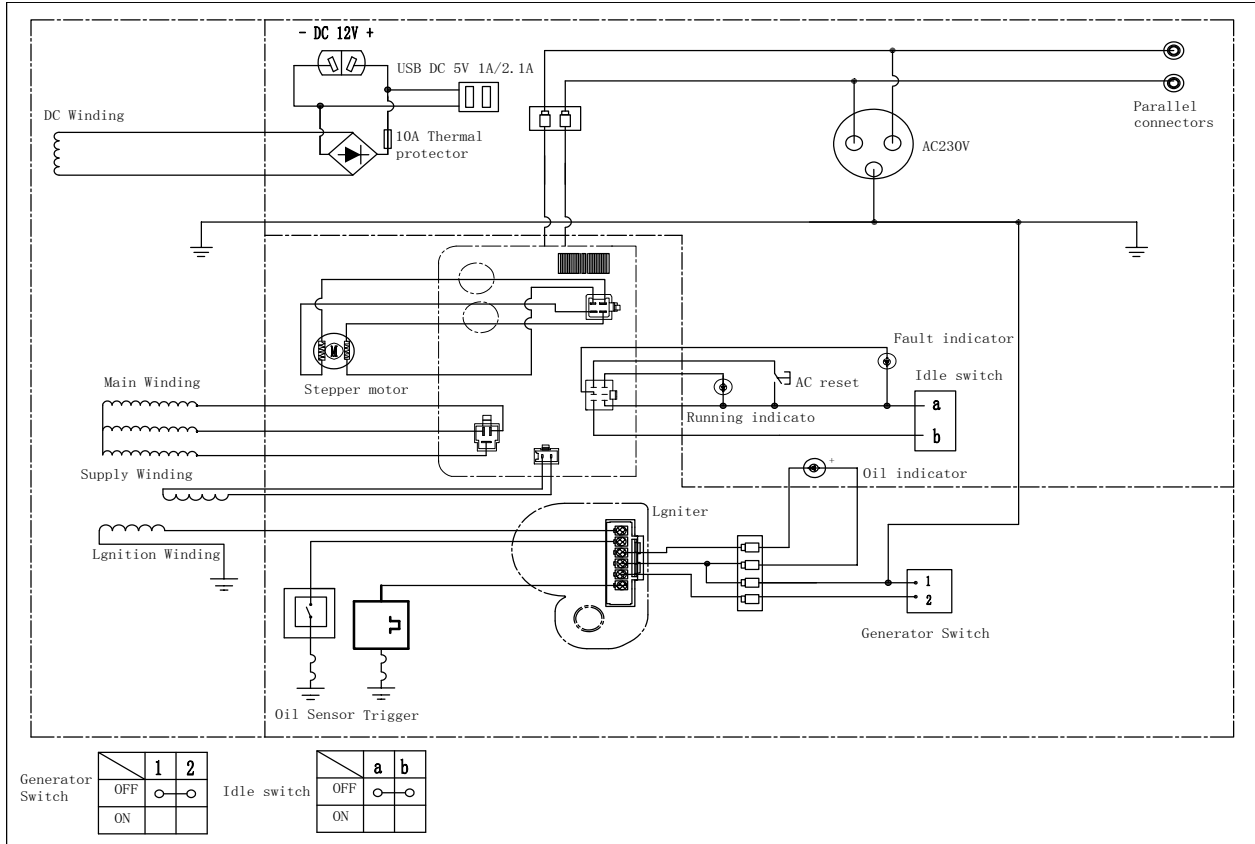





## **ОФИЦИАЛЬНЫЙ ДИЛЕР В УКРАИНЕ:**

[storgom.ua](https://storgom.ua)

## **ГРАФИК РАБОТЫ:**

Пн. – Пт.: с 8:30 по 18:30

Сб.: с 09:00 по 16:00

Вс.: с 10:00 по 16:00

## **КОНТАКТЫ:**

+38 (044) 360-46-77

+38 (066) 77-395-77

+38 (097) 77-236-77

+38 (093) 360-46-77

Детальное описание товара: <https://storgom.ua/product/mast-group-176159.html>

Другие товары: <https://storgom.ua/inventornye-generatory.html>