

PROFESSIONAL PNEUMATIC TOOLS

Q₁

Cat. #
0817
08/2017



SUNMATCH
Professional Pneumatic Tools

Company Profile

- **Established** : in March 1985
- **Factory Location** : 296-1 Chung Shan Road, Chupei City, Hsinchu County 30281, Taiwan
- **Capital** : NT\$370,000,000.00 (US\$12,200,000.00)
- **Turnover** : US\$43,000,000.00
- **CEO** : Daniel Chen
- **Employee** : 195
- **Factory Land** : 6,612 m² (71,170 feet²)
- **Factory Floor** : 23,140 m² (249,077 feet²)

Our Daily Challenge : Make a change or die.

Our Expectation : Develop more tools covering different industries and make them to the highest quality standards.

We Define : Sunmatch as a manufacturing company and partner of many different brands.

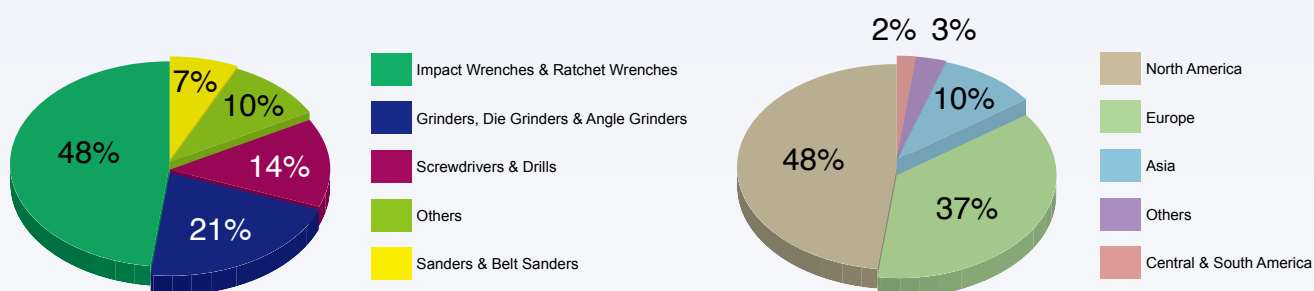

Sunmatch is a family owned company established in 1985, by three brothers.

Three Brothers

Daniel Chen is the eldest among three brothers and in charge of international marketing. The other two brothers, David and Peter, have mechanical engineering backgrounds and are in charge of developing and manufacturing new products. It has been a good combination to have three brothers working together, and as the old Chinese saying goes, "brothers working together will have enough power to break steel".

A dream

Our father was a bus driver with limited income. Our mother was selling vegetables in the traditional market to make a little money to help improve our living. Raised in a poor family, three brothers were encouraged by our father to study hard and work hard to be outstanding people. The dream is "united, brothers work together". Sunmatch allowed this dream to come true.

Dream comes true

At the time Sunmatch was established, David was the only one who knew a little about Pneumatic Tools, as he worked for a small company, named "FULLIN". In English, "FULLIN" means "luck is coming". But yet luck didn't come, soon "FULLIN" went bankrupt. David was in search of a new job. The three brothers decided to start manufacturing Pneumatic Tools and to locate the Sunmatch factory in their home town of Hsinchu. Peter was a teacher at a senior high school teaching mechanical engineering. Daniel had a background of international trade, as he had worked for a trading company. From that start, the three brothers worked together to make the dream come true.

Almost bankrupt

For the first ten years, Sunmatch made no money and almost went bankrupt because of cash flow. Sunmatch received orders from trading companies with very limited profits. In fact, Sunmatch was at the mercy of the trading companies. Make a change or die. Thank God, Sunmatch started growing with their direct export business to customers in countries worldwide. Sunmatch attended trade shows in different countries and talked to customers to help understand their needs.

Advice from customer

One of the reasons that Sunmatch made no profit was due to low prices, as Sunmatch only made DIY quality at that time. With low quality came low prices. One day, a customer said "Daniel, you have to make your own way in professional quality, or stay the same with DIY. I don't mind paying more if you could make better quality." We changed to higher quality products with higher prices. Thank God, Sunmatch is now on a new track with only Professional Quality!

A lesson of 25 years

It was a surprise to me when I was told that business relations could last 25 years. That was my first visit to the USA in August 1985, a few months after Sunmatch was established. My customer in the USA told me that his company had been doing business with a Japanese manufacturer for 25 years. 25 years was almost my whole life, as I was 30 years old that time. I was so impressed with such a long lasting relationship that I wanted to do the same with my customers. That was a great lesson for me. It has been 25 years since Sunmatch started in business and I am proud to say that I still keep a sound business relationship with my first customer.

An Expectation

I believe that I am a lucky man to have two brothers working with me on the same dream. With them, everything has become possible. The product range continues to improve while the quality has improved from DIY to Professional level. Even though Sunmatch went through a difficult stage in the beginning, we continue to grow. Our expectation is to develop more tools covering different industries and make them to the highest quality standards. At Sunmatch, we consider this a daily challenge. We define Sunmatch as a manufacturing company and partner of many different brands.

~ by Daniel Chen
2011/4/21

Contents

<i>Impact Wrenches</i>	4	<i>1/4" Industrial Air Screwdrivers</i>	124
<i>Angle Impact Wrench</i>	10	<i>Composite Housing Series</i>	132
<i>1/2" Impact Wrench Kits</i>	11	<i>1/4" Mini Air Drills</i>	137
<i>Mini Impact Wrenches</i>	15	<i>Air Drills</i>	139
<i>1/4" Hex Impact Drivers</i>	15	<i>3/8" Heavy Duty Angle Drills</i>	145
<i>Stubby Impact Wrenches</i>	18	<i>Air Metal Shears</i>	145
<i>1" Heavy Duty Impact Wrenches</i>	26	<i>0.5 HP & 1.0 HP Air Drills</i>	146
<i>1" Light Duty Impact Wrenches</i>	28	<i>0.5 HP Air Drills</i>	147
<i>Suspending Stand</i>	33	<i>Spot Drill</i>	149
<i>Ratchet Wrenches & Impact Ratchet Wrenches</i>	35	<i>Bead Breaker</i>	150
<i>Impact Ratchet Wrenches</i>	36	<i>Wheel Bolt Cleaner Kit</i>	151
<i>Stubby Ratchet Wrenches</i>	36	<i>Heavy-Duty Air Drill</i>	152
<i>Multi-Function Ratchet Wrench</i>	37	<i>Heavy-Duty Industrial Pneumatic Drills</i>	153
<i>Ratchet Wrenches & Kits</i>	38	<i>Four Bolt Chipping Hammers</i>	154
<i>Utility Surface Blaster</i>	41	<i>Paving Breakers</i>	155
<i>Die Grinders & Cut-Off Tool</i>	42	<i>Air Scribe and Engraving Chisel</i>	156
<i>Family Looking Tools</i>	47	<i>Wheel Bolt Cleaner Kit</i>	157
<i>Die Grinders - Industrial</i>	48	<i>Wheel Hub Bolt Grinder Kit</i>	158
<i>Mini Die Grinders</i>	50	<i>Utility Sanding Kit</i>	159
<i>0.4 HP & 0.7 HP Die Grinders</i>	60	<i>Wheel Hub Grinder</i>	160
<i>Angle Die Grinders</i>	61	<i>Exhaust Hose Assembly</i>	161
<i>Vertical Grinders- Heavy Industrial</i>	63	<i>Comfort Grips</i>	162
<i>Angle Grinder</i>	65	<i>Vibro Impact Air Hammers & Kits</i>	164
<i>Angle Grinders - Heavy Industrial</i>	68	<i>Hammers & Kits</i>	166
<i>7" Angle Grinders</i>	74	<i>Chipping Hammer</i>	167
<i>Angle Grinders & Sander</i>	75	<i>Flux Chipper</i>	170
<i>7" Angle Sanders & Polishers</i>	75	<i>Needle Scalars & Flux Chippers</i>	171
<i>Water Feed Tool Series</i>	76	<i>Needle Scaler & Scaling Hammer</i>	172
<i>Mini Angle Grinder & Kit</i>	78	<i>Ratchet Wrenches</i>	172
<i>Mini Angle Grinder / Cut-Off Tool</i>	79	<i>Ratchet Wrenches Kit</i>	173
<i>Mini Cut-Off Tools</i>	80	<i>Impact Wrenches & Kit</i>	173
<i>Cut-Off Tool</i>	81	<i>Impact Wrenches</i>	175
<i>3" Reversible Cut-Off Tools</i>	83	<i>Air Drills</i>	177
<i>1-1/4" Mini Random Orbital Nib Sander</i>	86	<i>Screwdrivers & Kit</i>	179
<i>Nib Removal Sanders</i>	88	<i>Straight Air Screwdrivers</i>	181
<i>3" Buffers</i>	89	<i>Stripping Tool & Tire Buffers</i>	182
<i>3", 4" & 5" Gear-Driven Sanders / Polishers</i>	90	<i>Family Looking Tools</i>	183
<i>5" & 6" Two-Hand Sanders</i>	91	<i>Die Grinders</i>	184
<i>Oil-Free Two-Hand Sanders</i>	91	<i>Die Grinders & Cut-Off Tool</i>	185
<i>Random Orbital Palm Sander</i>	92	<i>Engraving Tools</i>	186
<i>5", 6" & 8" Gear-Driven Sanders / Polishers</i>	97	<i>Micro Die Grinders</i>	186
<i>5" & 6" Vertical Sanders / Polishers</i>	98	<i>Micro Die Grinder & Kit</i>	187
<i>7" Vertical Sander / Polisher</i>	99	<i>Sanders</i>	188
<i>Reversible High Speed Sanders</i>	99	<i>Air Riveters</i>	189
<i>Mini Tool Series - Composite</i>	100	<i>Saws</i>	190
<i>Mini Tool Series</i>	103	<i>Window Cut-Off Knives</i>	191
<i>Finger Sanders</i>	109	<i>Punches</i>	191
<i>Air Trimmer</i>	109	<i>Scraper</i>	192
<i>Belt Sanders</i>	111	<i>Spray Guns</i>	192
<i>Belt Sanders & Kit</i>	112	<i>Filer / Shears / Nibbler</i>	193
<i>Belt Sander Kit</i>	113	<i>Double Suction Cups & Kits</i>	194
<i>Versatility Belt Sander</i>	116	<i>Two Way Gun & Kit</i>	194
<i>Auto Shut-Off Screwdrivers</i>	116	<i>Other Tools & Accessories</i>	195
<i>1/4" Air Screwdrivers</i>	122	<i>Tool Index</i>	i



Impact Wrenches

Features:

- **Composite Motor Housing**
- **Twin Hammer Clutch Mechanism**
- Push Button One Hand Forward / Reverse
- Available Optional Exhaust Hose Assembly
- Handle Exhaust
- 360° Swivel Air Inlet
- **Lightweight**
- **Low Noise 83 dB(A)**

Accessories (Optional)

Rubber Boot

#41-401255-0028

For SM-41-4012P & SM-43-4012P

#43-403355-0028

For SM-43-4033P & SM-43-4033PL



Air Regulator

(3 Different Speeds of Forward / Reverse)



▲ One Hand - Forward / Reverse

SM-41-4012P

3/8" Impact Wrench



SM-43-4012P

1/2" Mini Impact Wrench



SM-43-4033P

1/2" Impact Wrench



SM-43-4033PL

1/2" Impact Wrench
- with 2" Ext. Anvil



Patent No.

US D572,991 S
DE 20 2006 014 757 U1 / DE 20 2007 004 347 U1
DE 20 2007 010 291 U1
TW M305737 / M316787 / D117453 / M321349
Patent Pending in Multi-Countries

Specifications:

Model No.	Free Speed (RPM)	Anvil Size Inch (mm)	Loosening Torque (Max.) Ft-lbs (Nm)	Maximum Torque Ft-lbs (Nm)	Working Torque Range Ft-lbs (Nm)	Air Inlet (NPT)	Hose Size ID Inch (mm)	Average Air Consumption CFM (L/Min)	Length Inch (mm)	Weight Lbs (Kg)	Noise Level dB(A)
SM-41-4012P	11,000	3/8 (10)	-	430 (583)	25~250 (34~338)	1/4"	3/8 (10)	4 (113)	6 (153)	2.6 (1.2)	83
SM-43-4012P	11,000	1/2 (13)	960 (1,302)	460 (624)	25~250 (34~338)	1/4"	3/8 (10)	4 (113)	6 (153)	2.6 (1.2)	83
SM-43-4033P	7,000	1/2 (13)	1,300 (1,756)	820 (1,112)	50~580 (68~786)	1/4"	3/8 (10)	4 (113)	7.2 (183)	4 (1.9)	83
SM-43-4033PL	7,000	1/2 (13)	1,300 (1,756)	820 (1,112)	50~580 (68~786)	1/4"	3/8 (10)	4 (113)	9.3 (236)	4.4 (2.0)	83

* Recommended Air Pressure at 90 PSI (6.2 Bar)

* Max. Torque and Reverse Torque to be Tested by Removing Damping Material

Impact Wrenches

Features:

- **Composite Motor Housing**
- **Twin Hammer Clutch Mechanism**
- Push Button One Hand Forward / Reverse
- Available Optional Exhaust Hose Assembly
- Handle Exhaust
- 360° Swivel Air Inlet
- **Lightweight**
- **Low Noise 90 dB(A)**

Accessories (Optional)

Rubber Boot

#45-405165-0028

For SM-45-4051P, SM-47-4051P,
SM-45-4051PL & SM-47-4051PL



Exhaust Hose Assembly

EH-43-4033SUB

For 3/8" & 1/2" Impact Wrenches

EH-45-4051SUB

For 3/4" & 1" Impact Wrenches



SM-45-4051P

3/4" Impact Wrench



SM-47-4051P

1" Impact Wrench



SM-45-4051PL

3/4" Impact Wrench

- with 6" Ext. Anvil

SM-47-4051PL

1" Impact Wrench

- with 6" Ext. Anvil



Specifications:

Model No.	Free Speed (RPM)	Anvil Size Inch (mm)	Maximum Torque Ft-lbs (Nm)	Working Torque Range Ft-lbs (Nm)	Air Inlet (NPT)	Hose Size ID Inch (mm)	Average Air Consumption CFM (L/Min)	Length Inch (mm)	Weight Lbs (Kg)	Noise Level dB(A)
SM-45-4051P	5,500	3/4 (19)	1,500 (2,034)	200~1,200 (271~1,627)	3/8"	1/2 (13)	7 (198)	8.5 (215)	7.5 (3.4)	90
SM-45-4051PL	5,500	3/4 (19)	1,500 (2,034)	200~1,200 (271~1,627)	3/8"	1/2 (13)	7 (198)	14.5 (368)	8.8 (4.0)	90
SM-47-4051P	5,500	1 (25.4)	1,500 (2,034)	200~1,200 (271~1,627)	3/8"	1/2 (13)	7 (198)	8.8 (223)	7.7 (3.5)	90
SM-47-4051PL	5,500	1 (25.4)	1,500 (2,034)	200~1,200 (271~1,627)	3/8"	1/2 (13)	7 (198)	14.8 (376)	9.7 (4.4)	90

* Recommended Air Pressure at 90 PSI (6.2 Bar)

* Max. Torque and Reverse Torque to be Tested by Removing Damping Material

Impact Wrenches

Features:

- **Composite Motor Housing**
- **Twin Hammer Clutch Mechanism**
- Max. Torque : **Tightening 90-130 Nm** (66-96 ft.lbs) for SM-43-4012A, SM-43-4033A
Tightening 450-600 Nm (332-443 ft.lbs) for SM-45-4051A
Reverse 624 Nm (460 ft.lbs) for SM-43-4012A
Reverse 1,112 Nm (820 ft.lbs) for SM-43-4033A, SM-43-4033AL
Reverse 2,034 Nm (1,500 ft.lbs) for SM-45-4051A
- Available Optional Exhaust Hose Assembly
- Handle Exhaust
- 360° Swivel Air Inlet
- **Lightweight**
- **Low Noise**



▲ Operation of 1/2" Impact Wrench with Torque Controlled

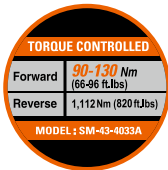

SM-43-4012A
1/2" Mini Impact Wrench



SM-43-4033A
1/2" Impact Wrench

Exhaust Hose Assembly

EH-43-4033SUB
For 3/8" & 1/2" Impact Wrenches

EH-45-4051SUB
For 3/4" & 1" Impact Wrenches



SM-43-4033AL
1/2" Impact Wrench
- with 2" Ext. Anvil



SM-45-4051A
3/4" Impact Wrench

Patent No.
 US D572,991 S
 DE 20 2006 014 757 U1 / DE 20 2007 004 347 U1
 DE 20 2007 010 291 U1
 TW M305737 / M316787 / D117453 / M321349
 Patent Pending in Multi-Countries

Specifications:

Model No.	Free Speed (F/R) (RPM)	Anvil Size Inch (mm)	Tightening Torque Ft-lbs (Nm)	Maximum Torque Ft-lbs (Nm)	Air Inlet (NPT)	Hose Size ID Inch (mm)	Average Air Consumption CFM (L/Min)	Length Inch (mm)	Weight Lbs (Kg)	Noise Level dB(A)
SM-43-4012A	7,500 / 12,000	1/2 (13)	66~96 (90~130)	460 (624)	1/4"	3/8 (10)	4 (113)	6 (153)	2.6 (1.2)	83
SM-43-4033A	3,500 / 8,000	1/2 (13)	66~96 (90~130)	820 (1,112)	1/4"	3/8 (10)	4 (113)	7.2 (183)	4 (1.9)	83
SM-43-4033AL	3,500 / 8,000	1/2 (13)	66~96 (90~130)	820 (1,112)	1/4"	3/8 (10)	4 (113)	9.3 (236)	4.4 (2)	83
SM-45-4051A	3,000 / 6,000	3/4 (19)	332~443 (450~600)	1,500 (2,034)	3/8"	1/2 (13)	7 (198)	8.5 (215)	7.5 (3.4)	90

* Recommended Air Pressure at 90 PSI (6.2 Bar) * Max. Torque and Reverse Torque to be Tested by Removing Damping Material

Impact Wrenches

Features:

- **Composite Motor Housing**
- **Pin Clutch Mechanism**
- Push Button One Hand Forward / Reverse
- Working Torque :
Range 50-650 ft.lbs (68-882 Nm)
- Max. Torque :
Reverse 1,000 ft.lbs (1,375 Nm)
- 360° Swivel Air Inlet
- **Lightweight 4 Lbs (1.9 Kg)**
- **Low Noise 83 dB(A)**

SM-43-4033P2

1/2" Impact Wrench
- Pin Clutch Mechanism

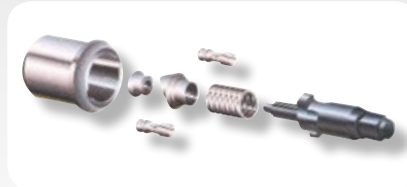

▲ Pin Clutch Mechanism



Features:

- **Composite Motor Housing**
- **Twin Hammer Clutch Mechanism**
- Dial Style Forward / Reverse with 3 Speeds in Forward and Full Power Reverse
- Handle Exhaust
- 360° Swivel Air Inlet

SM-43-4031P1

1/2" Impact Wrench



▲ 3 Different Speeds of Forward & Full Power of Reverse



SM-43-4031P3

1/2" Impact Wrench



▲ 3 Different Speeds of Forward & Full Power of Reverse



Patent No.

US D7,174,971 B1
DE 20 2005 020 352 U1
TW M290804
Patent Pending in Multi-Countries

Specifications:

Model No.	Free Speed (RPM)	Anvil Size Inch (mm)	Maximum Torque Ft-lbs (Nm)	Working Torque Range Ft-lbs (Nm)	Air Inlet (NPT)	Hose Size ID Inch (mm)	Average Air Consumption CFM (L/Min)	Length Inch (mm)	Weight Lbs (Kg)	Noise Level dB(A)
SM-43-4033P2	7,000	1/2 (13)	1,000 (1,375)	50~650 (68~882)	1/4"	3/8 (10)	4 (113)	7.4 (189)	4 (1.9)	83
SM-43-4031P1	7,000	1/2 (13)	680 (922)	50~550 (68~746)	1/4"	1/2 (13)	4.4 (125)	8 (204)	4.8 (2.2)	88
SM-43-4031P3	7,000	1/2 (13)	680 (922)	50~550 (68~746)	1/4"	1/2 (13)	4.4 (125)	8 (204)	4.8 (2.2)	88

* Recommended Air Pressure at 90 PSI (6.2 Bar)

* Max. Torque and Reverse Torque to be Tested by Removing Damping Material

Impact Wrenches

Features:

- Composite Motor Housing
- Lightweight
- Handle Exhaust
- **Low Noise 83 dB(A)**
- **Twin Hammer Clutch Mechanism**
- Available Optional Exhaust Hose Assembly
- Push Button One Hand Forward / Reverse

Accessories (Optional)

Rubber Boot

#41-402455-0028

For SM-41-4024P & SM-43-4024P

#43-403455-0028

For SM-43-4034P & SM-43-4034PL



Air Regulator

(3 Different Speeds of Forward / Reverse)



Forward

Reverse

▲ One Hand - Forward / Reverse

SM-41-4024P

3/8" Impact Wrench



SM-43-4024P

1/2" Mini Impact Wrench



SM-43-4034P

1/2" Impact Wrench



SM-43-4034PL

1/2" Impact Wrench
- with 2" Ext. Anvil



Specifications :

Model No.	Free Speed (RPM)	Anvil Size Inch (mm)	Loosening Torque (Max.) Ft-lbs (Nm)	Maximum Torque Ft-lbs (Nm)	Working Torque Range Ft-lbs (Nm)	Air Inlet (NPT)	Hose Size Inch (mm)	Average Air Consumption CFM (L/Min)	Length Inch (mm)	Weight Lbs (Kg)	Noise Level dB(A)
SM-41-4024P	11,000	3/8 (10)	-	430 (583)	25-250 (34-338)	1/4"	3/8 (10)	4 (113)	6 (153)	2.6 (1.2)	83
SM-43-4024P	11,000	1/2 (13)	960 (1,302)	460 (624)	25-250 (34-338)	1/4"	3/8 (10)	4 (113)	6 (153)	2.6 (1.2)	83
SM-43-4034P	7,000	1/2 (13)	1,300 (1,756)	820 (1,112)	50-580 (68-786)	1/4"	3/8 (10)	4 (113)	7.2 (183)	4 (1.9)	83
SM-43-4034PL	7,000	1/2 (13)	1,300 (1,756)	820 (1,112)	50-580 (68-786)	1/4"	3/8 (10)	4 (113)	9.3 (236)	4.3 (1.97)	83

* Recommended Air Pressure at 90 PSI (6.2 Bar)

* Max. Torque and Reverse Torque to be Tested by Removing Damping Material

Impact Wrenches

Features:

- Composite Motor Housing
- Lightweight
- Handle Exhaust
- **Low Noise 90 dB(A)**
- **Twin Hammer Clutch Mechanism**
- Available Optional Exhaust Hose Assembly
- Push Button One Hand Forward / Reverse

Accessories (Optional)

Rubber Boot

#45-405455-0028

For SM-45-4054P, SM-47-4054P,
SM-45-4054PL & SM-47-4054PL



Exhaust Hose Assembly

EH-43-4033SUB

For 3/8" & 1/2" Impact Wrenches

EH-45-4051SUB

For 3/4" & 1" Impact Wrenches



SM-45-4054P

3/4" Impact Wrench



SM-47-4054P

1" Impact Wrench



SM-45-4054PL

3/4" Impact Wrench

– with 6" Ext. Anvil



SM-47-4054PL

1" Impact Wrench

– with 6" Ext. Anvil

Specifications:

Model No.	Free Speed (RPM)	Anvil Size Inch (mm)	Maximum Torque Ft-lbs (Nm)	Working Torque Range Ft-lbs (Nm)	Air Inlet (NPT)	Hose Size ID Inch (mm)	Average Air Consumption CFM (L/Min)	Length Inch (mm)	Weight Lbs (Kg)	Noise Level dB(A)
SM-45-4054P	5,500	3/4 (19)	1,500 (2,034)	200~1,200 (271~1,627)	3/8"	1/2 (13)	7 (198)	8.5 (215)	7.3 (3.3)	90
SM-45-4054PL	5,500	3/4 (19)	1,500 (2,034)	200~1,200 (271~1,627)	3/8"	1/2 (13)	7 (198)	14.5 (368)	8.6 (3.9)	90
SM-47-4054P	5,500	1 (25.4)	1,500 (2,034)	200~1,200 (271~1,627)	3/8"	1/2 (13)	7 (198)	8.8 (223)	7.5 (3.4)	90
SM-47-4054PL	5,500	1 (25.4)	1,500 (2,034)	200~1,200 (271~1,627)	3/8"	1/2 (13)	7 (198)	14.5 (368)	9.5 (4.3)	90

* Recommended Air Pressure at 90 PSI (6.2 Bar)

* Max. Torque and Reverse Torque to be Tested by Removing Damping Material

Angle Impact Wrench

Features:

- Aluminum Motor Housing
- Composite Handle
- **Jumbo Hammer** Mechanism
- One Hand Forward / Reverse
- Handle Exhaust (Silencer)
- Compact and Powerful



SM-43-4010

1/2" Angle Impact Wrench
- Jumbo Hammer

Specifications:

Model No.	Free Speed (RPM)	Anvil Size Inch (mm)	Maximum Torque Ft-lbs (Nm)	Working Torque Range Ft-lbs (Nm)	Air Inlet (NPT)	Hose Size ID Inch (mm)	Average Air Consumption CFM (L/Min)	Length Inch (mm)	Weight Lbs (Kg)
SM-43-4010	8,000	1/2 (13)	230 (312)	20~170 (27~231)	1/4"	3/8 (10)	4 (113)	3.5 (88)	2.62 (1.19)

* Recommended Air Pressure at 90 PSI (6.2 Bar)

* Max. Torque and Reverse Torque to be Tested by Removing Damping Material

1/2" Impact Wrench Kits

Features:

- Composite Motor Housing
- **Twin Hammer Clutch Mechanism**
- **Lightweight**
- 360° Swivel Air Inlet
- **Low Noise 83 dB(A)**

SM-43-4033PK3

1/2" Impact Wrench Kit



Kit Includes:

- 1 pc SM-43-4033P 1/2" Impact Wrench - Twin Hammer
- 10 pcs Sockets set
incl : 9, 10, 11, 13, 14, 17, 19, 22, 24, 27 mm
- 1 pc Extension Bar
- 1 pc Universal Joint
- 1 pc Nipple
- 1 pc Blow Molded Case

Kit Includes:

- 1 pc SM-43-4033P 1/2" Impact Wrench - Twin Hammer
- 1 pc RFG2254 1/2" Reversible Ratchet
- 3 pcs 6 Point 1/2" Deep (Long) Socket set:
17, 19 & 21mm (Chrome plated+Black)
- 16 pcs 6 Point 1/2" Sockets set : (CR-MO) (Chrome plated+Black)
incl : 10, 11, 12, 13, 14, 15, 16, 17, 18, 19, 21, 22, 24, 27, 30, 32mm
- 1 pc Nipple
- 1 pc Blow Molded Case



▲ Sockets set for **SM-43-4033PK2**

SM-43-4033PK2

1/2" Impact Wrench Kit



SM-43-4033PK

1/2" Impact Wrench Kit



Kit Includes:

- 1 pc SM-43-4033P 1/2" Impact Wrench
- 3 pcs Standard Sockets set:
17, 19 & 21mm
- 3 pcs Deep (Long) Sockets set
with sleeve: 17, 19 & 21mm
- 1 pc Blow Molded Case

Patent No.

US D572,991 S
 DE 20 2007 004 347 U1
 TAIWAN No. M305737 / M316787
 TAIWAN No. D117453 / M321349
 Patent Pending in Multi-Countries

Specifications:

Model No.	Free Speed (RPM)	Anvil Size Inch (mm)	Loosening Torque (Max.) Ft-lbs (Nm)	Maximum Torque Ft-lbs (Nm)	Working Torque Range Ft-lbs (Nm)	Air Inlet (NPT)	Hose Size ID Inch (mm)	Average Air Consumption CFM (L/Min)	Length Inch (mm)	Weight Lbs (Kg)	Noise Level dB(A)
SM-43-4033P	7,000	1/2 (13)	1,300 (1,756)	820 (1,112)	50~580 (68~786)	1/4"	3/8 (10)	4 (113)	7.2 (183)	4 (1.9)	83

* Recommended Air Pressure at 90 PSI (6.2 Bar)

* Max. Torque and Reverse Torque to be Tested by Removing Damping Material

Impact Wrenches

Features:

- Composite Motor Housing
- **Twin Hammer Clutch Mechanism**
- Push Button One Hand Forward / Reverse
- Available Optional Exhaust Hose Assembly
- Handle Exhaust
- 360° Swivel Air Inlet
- **Lightweight**
- **Low Noise 83 dB(A)**

Air Regulator

(3 Different Speeds of Forward / Reverse)



Forward Reverse

▲ One Hand - Forward / Reverse



▲ EH-43-4033SUB (Option)

SM-41-4019P

3/8" Impact Wrench



SM-43-4019P

1/2" Mini Impact Wrench



SM-43-4039P

1/2" Impact Wrench



SM-43-4039PL

1/2" Impact Wrench

- with 2" Ext. Anvil



Specifications:

Model No.	Free Speed (RPM)	Anvil Size Inch (mm)	Loosening Torque (Max.) Ft-lbs (Nm)	Maximum Torque Ft-lbs (Nm)	Working Torque Range Ft-lbs (Nm)	Air Inlet (NPT)	Hose Size ID Inch (mm)	Average Air Consumption CFM (L/Min)	Length Inch (mm)	Weight Lbs (Kg)	Noise Level dB(A)
SM-41-4019P	11,000	3/8 (10)	-	430 (583)	25~250 (34~338)	1/4"	3/8 (10)	4 (113)	6 (153)	2.6 (1.2)	83
SM-43-4019P	11,000	1/2 (13)	960 (1,302)	460 (624)	25~250 (34~338)	1/4"	3/8 (10)	4 (113)	6 (153)	2.6 (1.2)	83
SM-43-4039P	7,000	1/2 (13)	1,300 (1,756)	820 (1,112)	50~580 (68~786)	1/4"	3/8 (10)	4 (113)	7.2 (183)	4 (1.9)	83
SM-43-4039PL	7,000	1/2 (13)	1,300 (1,756)	820 (1,112)	50~580 (68~786)	1/4"	3/8 (10)	4 (113)	9.3 (236)	4.4 (2.0)	83

* Recommended Air Pressure at 90 PSI (6.2 Bar)

* Max. Torque and Reverse Torque to be Tested by Removing Damping Material

Impact Wrenches

Features:

- **Composite Motor Housing**
- **Twin Hammer Clutch Mechanism**
- Push Button One Hand Forward / Reverse
- Available Optional Exhaust Hose Assembly
- Handle Exhaust
- 360° Swivel Air Inlet
- **Lightweight**
- **Low Noise 90 dB(A)**

Air Regulator

(3 Different Speeds of Forward / Reverse)



▲ One Hand - Forward / Reverse



▲ EH-45-4051SUB (Option)

SM-45-4059P

3/4" Impact Wrench



SM-47-4059P

1" Impact Wrench



SM-45-4059PL

3/4" Impact Wrench

- with 6" Ext. Anvil

SM-47-4059PL

1" Impact Wrench

- with 6" Ext. Anvil



Specifications:

Model No.	Free Speed (RPM)	Anvil Size Inch (mm)	Maximum Torque Ft-lbs (Nm)	Working Torque Range Ft-lbs (Nm)	Air Inlet (NPT)	Hose Size ID Inch (mm)	Average Air Consumption CFM (L/Min)	Length Inch (mm)	Weight Lbs (Kg)	Noise Level dB(A)
SM-45-4059P	5,500	3/4 (19)	1,500 (2,034)	200~900 (271~1,224)	3/8"	1/2 (13)	7 (198)	8.5 (215)	7.5 (3.4)	90
SM-45-4059PL	5,500	3/4 (19)	1,500 (2,034)	200~900 (271~1,224)	3/8"	1/2 (13)	7 (198)	14.5 (368)	8.8 (4.0)	90
SM-47-4059P	5,500	1 (25.4)	1,500 (2,034)	200~900 (271~1,224)	3/8"	1/2 (13)	7 (198)	8.8 (223)	7.7 (3.5)	90
SM-47-4059PL	5,500	1 (25.4)	1,500 (2,034)	200~900 (271~1,224)	3/8"	1/2 (13)	7 (198)	14.5 (368)	9.7 (4.4)	90

* Recommended Air Pressure at 90 PSI (6.2 Bar)

* Max. Torque and Reverse Torque to be Tested by Removing Damping Material

Impact Wrenches

Features:

- **Composite Motor Housing**
- **Twin Hammer Clutch Mechanism**
- Max. Torque : **Tightening 90-130 Nm** (66-96 ft.lbs) for SM-43-4019A, SM-43-4039A
Tightening 450-600 Nm (332-443 ft.lbs) for SM-45-4059A
Reverse 624 Nm (460 ft.lbs) for SM-43-4019A
Reverse 1,112 Nm (820 ft.lbs) for SM-43-4039A
Reverse 2,034 Nm (1,500 ft.lbs) for SM-45-4059A
- Available Optional Exhaust Hose Assembly
- Handle Exhaust
- 360° Swivel Air Inlet
- **Lightweight**
- **Low Noise**



Torque Controlled



SM-43-4019A
1/2" Mini Impact Wrench



SM-43-4039A
1/2" Impact Wrench



SM-45-4059A
3/4" Impact Wrench

Specifications:

Model No.	Free Speed (F/R) (RPM)	Anvil Size Inch (mm)	Tightening Torque Ft-lbs (Nm)	Maximum Torque Ft-lbs (Nm)	Air Inlet (NPT)	Hose Size ID Inch (mm)	Average Air Consumption CFM (L/Min)	Length Inch (mm)	Weight Lbs (Kg)	Noise Level dB(A)
SM-43-4019A	7,500 / 12,000	1/2 (13)	66~96 (90~130)	460 (624)	1/4"	3/8 (10)	4 (113)	6 (153)	2.6 (1.2)	83
SM-43-4039A	3,500 / 8,000	1/2 (13)	66~96 (90~130)	820 (1,112)	1/4"	3/8 (10)	4 (113)	7.2 (183)	4 (1.9)	83
SM-45-4059A	3,000 / 6,000	3/4 (19)	332~443 (450~600)	1,500 (2,034)	3/8"	1/2 (13)	7 (198)	8.5 (215)	7.5 (3.4)	90

* Recommended Air Pressure at 90 PSI (6.2 Bar)

* Max. Torque and Reverse Torque to be Tested by Removing Damping Material

Mini Impact Wrenches

Features:

- **Composite Motor Housing**
(Double Injection only for SM-40-7253P & SM-41-7253P)
- Reversing Bar on Both Sides
- **Two Speed Trigger**
(Slow Speed When Pulled Halfway)
- Handle Exhaust
- **Patented Silencer 83 dB(A)**
- **0.5 HP**

Quiet Series

SM-41-7253P

3/8" Mini Impact Wrench



SM-41-7254P

3/8" Mini Impact Wrench



SM-40-7253P

1/4" Mini Impact Wrench



SM-40-7254P

1/4" Mini Impact Wrench

Patent No.

US D582,236 S / US D582,237 S
TW M346502 / M346497
Patent Pending in Multi-Countries

Specifications:

Model No.	Free Speed (RPM)	Anvil Size (Inch (mm))	Maximum Torque (Ft-lbs (Nm))	Working Torque Range (Ft-lbs (Nm))	Air Inlet (NPT)	Hose Size ID (Inch (mm))	Average Air Consumption (CFM (L/Min))	Length (Inch (mm))	Weight (Lbs (Kg))	Noise Level (dB(A))
SM-40-7253P	11,000	1/4 (6)	75 (102)	25~70 (34~95)	1/4"	3/8 (10)	4 (113)	6.7 (170)	2.2 (1.0)	83
SM-40-7254P	11,000	1/4 (6)	75 (102)	25~70 (34~95)	1/4"	3/8 (10)	4 (113)	6.7 (170)	2.2 (1.0)	83
SM-41-7253P	11,000	3/8 (10)	100 (136)	25~90 (34~122)	1/4"	3/8 (10)	4 (113)	6.9 (174)	2.2 (1.0)	83
SM-41-7254P	11,000	3/8 (10)	100 (136)	25~90 (34~122)	1/4"	3/8 (10)	4 (113)	6.9 (174)	2.2 (1.0)	83

* Recommended Air Pressure at 90 PSI (6.2 Bar)

* Max. Torque and Reverse Torque to be Tested by Removing Damping Material

1/4" Hex Impact Drivers

Features:

- **Composite Motor Housing**
(Double Injection only for SM-48-7253P)
- Reverse Bar On Both Sides
- **Two Speed Trigger**
- **Patented Silencer 84 dB(A)**
- Handle Exhaust
- **0.5 HP**

Composite

SM-48-7253P

1/4" Hex Impact Driver



SM-48-7254P

1/4" Hex Impact Driver



Specifications:

Model No.	Free Speed (RPM)	Hex Drive Capacity (Inch)	Maximum Torque (Ft-lbs (Nm))	Working Torque Range (Ft-lbs (Nm))	Air Inlet (NPT)	Hose Size ID (Inch (mm))	Average Air Consumption (CFM (L/Min))	Length (Inch (mm))	Weight (Lbs (Kg))	Noise Level (dB(A))
SM-48-7253P	11,000	1/4	75 (102)	25~40 (34~54)	1/4"	3/8 (10)	4 (113)	7.1 (181)	2.2 (1.0)	84
SM-48-7254P	11,000	1/4	75 (102)	25~40 (34~54)	1/4"	3/8 (10)	4 (113)	7.1 (181)	2.2 (1.0)	84

* Recommended Air Pressure at 90 PSI (6.2 Bar)

Impact Wrenches

Features:

- **Composite Motor Housing**
- **Push Button One Hand Forward / Reverse**
- **Handle Exhaust (Silencer)**
- **Compact and Powerful**



▲ One Hand - Forward / Reverse



SM-41-4015P

3/8" Stubby Impact Wrench

- Twin Hammer



SM-43-4015P

1/2" Stubby Impact Wrench

- Twin Hammer

SM-41-4015P2

3/8" Stubby Impact Wrench

- Jumbo Hammer



SM-43-4015P2

1/2" Stubby Impact Wrench

- Jumbo Hammer

Specifications:

Model No.	Free Speed (RPM)	Anvil Size Inch (mm)	Loosening Torque (Max.) Ft-lbs (Nm)	Maximum Torque Ft-lbs (Nm)	Working Torque Range Ft-lbs (Nm)	Air Inlet (NPT)	Hose Size ID Inch (mm)	Average Air Consumption CFM (L/Min)	Length Inch (mm)	Weight Lbs (Kg)
SM-41-4015P	10,000	3/8 (10)	-	700 (949)	25~350 (34~475)	1/4"	3/8 (10)	4.9 (139)	5.1 (130)	2.78 (1.26)
SM-43-4015P	10,000	1/2 (13)	1,033 (1,400)	700 (949)	25~350 (34~475)	1/4"	3/8 (10)	4.9 (139)	5.1 (130)	2.8 (1.27)
SM-41-4015P2	10,000	3/8 (10)	-	700 (949)	25~350 (34~475)	1/4"	3/8 (10)	4.9 (139)	4.7 (120)	2.64 (1.2)
SM-43-4015P2	10,000	1/2 (13)	1,033 (1,400)	700 (949)	25~350 (34~475)	1/4"	3/8 (10)	4.9 (139)	4.7 (120)	2.67 (1.21)

* Recommended Air Pressure at 90 PSI (6.2 Bar) * Max. Torque and Reverse Torque to be Tested by Removing Damping Material

Impact Wrenches

Features:

- Compact and Powerful
- Aluminum Handle with Steel Clutch Housing

Compact & Powerful



SM-41-4001

3/8" Stubby Impact Wrench

- Twin Hammer

SM-43-4001

1/2" Stubby Impact Wrench

- Twin Hammer



SM-41-4002

3/8" Stubby Impact Wrench

- Jumbo Hammer

SM-43-4002

1/2" Stubby Impact Wrench

- Jumbo Hammer

Specifications:

Model No.	Free Speed (RPM)	Anvil Size Inch (mm)	Loosening Torque (Max.) Ft-lbs (Nm)	Maximum Torque Ft-lbs (Nm)	Working Torque Range Ft-lbs (Nm)	Air Inlet (NPT)	Hose Size ID Inch (mm)	Average Air Consumption CFM (L/Min)	Length Inch (mm)	Weight Lbs (Kg)
SM-41-4001	10,000	3/8 (10)	-	500 (678)	25~300 (34~407)	1/4"	3/8 (10)	4 (113)	4.7 (120)	3.4 (1.54)
SM-43-4001	10,000	1/2 (13)	960 (1,302)	500 (678)	25~300 (34~407)	1/4"	3/8 (10)	4 (113)	4.7 (120)	3.4 (1.54)
SM-41-4002	10,000	3/8 (10)	-	500 (678)	25~300 (34~407)	1/4"	3/8 (10)	4 (113)	4.3 (109)	3.2 (1.44)
SM-43-4002	10,000	1/2 (13)	960 (1,302)	500 (678)	25~300 (34~407)	1/4"	3/8 (10)	4 (113)	4.3 (109)	3.2 (1.44)

* Recommended Air Pressure at 90 PSI (6.2 Bar)

* Max. Torque and Reverse Torque to be Tested by Removing Damping Material

Stubby Impact Wrench

Features:

- **Composite Motor Housing**
- **Handle Exhaust (Silencer)**
- **One Hand Forward / Reverse**
- **Compact and Powerful**



SM-43-4011P
1/2" Stubby Impact Wrench
- Twin Hammer

SM-43-4011P2
1/2" Stubby Impact Wrench
- Jumbo Hammer

Specifications:

Model No.	Free Speed (RPM)	Anvil Size Inch (mm)	Loosening Torque (Max.) Ft-lbs (Nm)	Maximum Torque Ft-lbs (Nm)	Working Torque Range Ft-lbs (Nm)	Air Inlet (NPT)	Hose Size ID Inch (mm)	Average Air Consumption CFM (L/Min)	Length Inch (mm)	Weight Lbs (Kg)
SM-43-4011P	9,000	1/2 (13)	864 (1,172)	450 (610)	25~230 (34~312)	1/4"	3/8 (10)	4.5 (127)	3.9 (98)	2.45 (1.11)
SM-43-4011P2	9,000	1/2 (13)	864 (1,172)	450 (610)	25~230 (34~312)	1/4"	3/8 (10)	4.5 (127)	3.7 (93)	2.38 (1.08)

* Recommended Air Pressure at 90 PSI (6.2 Bar)

* Max. Torque and Reverse Torque to be tested by Removing Damping Material

Stubby Impact Wrench

Features:

- **Composite Motor Housing**
- **Handle Exhaust (Silencer)**
- **One Hand Forward / Reverse**
- **Compact and Powerful**



SM-43-4013P

1/2" Stubby Impact Wrench
- *Twin Hammer*



SM-43-4013P2

1/2" Stubby Impact Wrench
- *Jumbo Hammer*

Specifications:

Model No.	Free Speed (RPM)	Anvil Size Inch (mm)	Loosening Torque (Max.) Ft-lbs (Nm)	Maximum Torque Ft-lbs (Nm)	Working Torque Range Ft-lbs (Nm)	Air Inlet (NPT)	Hose Size ID Inch (mm)	Average Air Consumption CFM (L/Min)	Length Inch (mm)	Weight Lbs (Kg)
SM-43-4013P	9,000	1/2 (13)	940 (1,275)	500 (678)	25~320 (34~434)	1/4"	3/8 (10)	5.8 (164)	4.4 (112)	2.56 (1.16)
SM-43-4013P2	8,000	1/2 (13)	940 (1,275)	500 (678)	25~320 (34~434)	1/4"	3/8 (10)	5.8 (164)	3.9 (98)	2.45 (1.11)

* Recommended Air Pressure at 90 PSI (6.2 Bar)

* Max. Torque and Reverse Torque to be tested by Removing Damping Material

Impact Wrenches

Features:

- **Composite** Motor Housing
- **Twin Hammer**
- Thumb Operated Forward and Reverse Switches Provide One Hand Operation
- Variable Speed Trigger

Air Regulator

(3 Different Speeds of Forward / Reverse)



Reverse

Forward

▲ One Hand - Forward / Reverse

SM-41-4114P

3/8" Impact Wrench



SM-43-4114P

1/2" Mini Impact Wrench



SM-43-4134P

1/2" Impact Wrench



SM-43-4134L

1/2" Impact Wrench
- with 2" Ext. Anvil

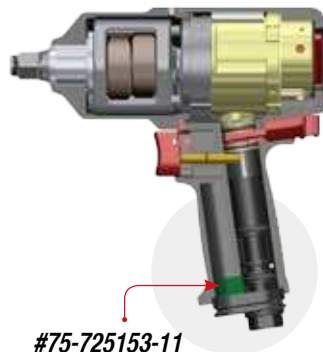

#75-725153-11

Muffer Material for Quiet Series (Optional)

▲ Low Noise Model for Europe
(Model No. ended with "Q",
Example : SM-43-4134PQ)

Specifications:

Model No.	Free Speed (RPM)	Anvil Size Inch (mm)	Maximum Torque Ft-lbs (Nm)	Loosening Torque (Max.) Ft-lbs (Nm)	Working Torque Range Ft-lbs (Nm)	Air Inlet (NPT)	Hose Size ID Inch (mm)	Average Air Consumption CFM (L/Min)	Length Inch (mm)	Weight Lbs (Kg)
SM-41-4114P	12,000	3/8 (10)	430 (583)	-	25~250 (34-338)	1/4"	3/8 (10)	4 (113)	6.2 (157)	2.73 (1.24)
SM-43-4114P	12,000	1/2 (13)	460 (624)	960 (1,302)	25~250 (34-338)	1/4"	3/8 (10)	4 (113)	6.2 (157)	2.73 (1.24)
SM-43-4134P	8,000	1/2 (13)	820 (1,112)	1,300 (1,756)	50~580 (68~786)	1/4"	3/8 (10)	4 (113)	7.4 (187)	4.21 (1.91)
SM-43-4134L	8,000	1/2 (13)	820 (1,112)	1,300 (1,756)	50~580 (68~786)	1/4"	3/8 (10)	4 (113)	9.4 (239)	4.47 (2.03)

* Recommended Air Pressure at 90 PSI (6.2 Bar)

* Max. Torque and Reverse Torque to be Tested by Removing Damping Material

Impact Wrenches

Features:

- **Composite** Motor Housing
- **Twin Hammer**
- Thumb Operated Forward and Reverse Switches Provide One Hand Operation
- Variable Speed Trigger

Air Regulator

(3 Different Speeds of Forward / Reverse)



Reverse

Forward

▲ One Hand - Forward / Reverse

SM-45-4154P

3/4" Impact Wrench



SM-47-4154P

1" Impact Wrench



SM-45-4154L

3/4" Impact Wrench

- with 6" Ext. Anvil

SM-47-4154L

1" Impact Wrench

- with 6" Ext. Anvil



Specifications:

Model No.	Free Speed (RPM)	Anvil Size Inch (mm)	Maximum Torque Ft-lbs (Nm)	Working Torque Range Ft-lbs (Nm)	Air Inlet (NPT)	Hose Size ID Inch (mm)	Average Air Consumption CFM (L/Min)	Length Inch (mm)	Weight Lbs (Kg)
SM-45-4154P	5,500	3/4 (19)	1,500 (2,034)	200~1,200 (271~1,627)	3/8"	1/2 (13)	7 (198)	8.7 (220)	7.59 (3.44)
SM-47-4154P	5,500	1 (25.4)	1,500 (2,034)	200~1,200 (271~1,627)	3/8"	1/2 (13)	7 (198)	9 (228)	7.78 (3.53)
SM-45-4154L	5,500	3/4 (19)	1,500 (2,034)	200~1,200 (271~1,627)	3/8"	1/2 (13)	7 (198)	14.7 (373)	8.9 (4.04)
SM-47-4154L	5,500	1 (25.4)	1,500 (2,034)	200~1,200 (271~1,627)	3/8"	1/2 (13)	7 (198)	15 (381)	9.74 (4.42)

* Recommended Air Pressure at 90 PSI (6.2 Bar)

* Max. Torque and Reverse Torque to be Tested by Removing Damping Material

Impact Wrench

Features:

- **Composite** Motor Housing
- **Twin Hammer**
- Thumb Operated Forward and Reverse Switches Provide One Hand Operation
- Variable Speed Trigger
- **1.81 kg**

SM-45-4134P

3/4" Mini Impact Wrench

176 mm

Air Regulator
(3 Different Speeds of Forward / Reverse)



Reverse Forward

▲ One Hand - Forward / Reverse



#75-725153-11

Muffer Material for Quiet Series (Optional)

▲ Low Noise Model for Europe

(Model No. ended with "Q",
Example : SM-45-4134PQ)



Specifications:

Model No.	Free Speed (RPM)	Anvil Size Inch (mm)	Maximum Torque Ft-lbs (Nm)	Loosening Torque (Max.) Ft-lbs (Nm)	Working Torque Range Ft-lbs (Nm)	Air Inlet (NPT)	Hose Size ID Inch (mm)	Average Air Consumption CFM (L/Min)	Length Inch (mm)	Weight Lbs (Kg)
SM-45-4134P	8,000	3/4 (19)	820 (1,112)	1,300 (1,756)	50~580 (68~786)	1/4"	3/8 (10)	4 (113)	6.9 (176)	3.99 (1.81)

* Recommended Air Pressure at 90 PSI (6.2 Bar)

Impact Wrenches

Features:

- **Composite** Motor Housing
- Handle Exhaust (Silencer)
- **Twin Hammer / Pin Clutch**
- Reverse : Full Power
- Forward : 3 Different Speeds

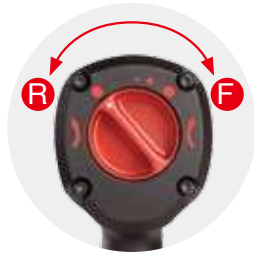

Patent No.

TW M453569 / D159427
Patent Pending in Multi-Countries



SM-43-4133PL

1/2" Impact Wrench
- with 2" Ext. Anvil
- Twin Hammer

SM-41-4113P

3/8" Impact Wrench
- Twin Hammer



SM-43-4113P

1/2" Mini Impact Wrench
- Twin Hammer



SM-45-4153P

3/4" Impact Wrench
- Twin Hammer



SM-43-4133P1

1/2" Impact Wrench
- Twin Hammer



SM-47-4153P

1" Impact Wrench
- Twin Hammer



SM-43-4133P2

1/2" Impact Wrench
- Pin Clutch

Specifications :

Model No.	Free Speed (RPM)	Anvil Size Inch (mm)	Loosening Torque (Max.) Ft-lbs (Nm)	Maximum Torque Ft-lbs (Nm)	Working Torque Range Ft-lbs (Nm)	Air Inlet (NPT)	Hose Size ID Inch (mm)	Average Air Consumption CFM (L/Min)	Length Inch (mm)	Weight Lbs (Kg)
SM-41-4113P	11,000	3/8 (10)	-	430 (583)	25~250 (34-338)	1/4"	3/8 (10)	4 (113)	6.2 (157)	2.84 (1.29)
SM-43-4113P	11,000	1/2 (13)	-	460 (624)	25~250 (34-338)	1/4"	3/8 (10)	4 (113)	6.2 (157)	2.84 (1.29)
SM-43-4133P1	9,000	1/2 (13)	1,100 (1,492)	780 (1,054)	50~550 (68~746)	1/4"	3/8 (10)	4.4 (125)	7.3 (186)	4.5 (2.04)
SM-43-4133P2	8,000	1/2 (13)	-	780 (1,054)	50~550 (68~746)	1/4"	3/8 (10)	4.4 (125)	7.6 (192)	4.58 (2.08)
SM-43-4133PL	9,000	1/2 (13)	1,100 (1,492)	780 (1,054)	50~550 (68~746)	1/4"	3/8 (10)	4.4 (125)	7.3 (186)	4.74 (2.15)
SM-45-4153P	5,500	3/4 (19)	-	1500 (2,034)	200~1200 (271~1627)	3/8"	1/2 (13)	7 (198)	8.7 (220)	8.35 (3.79)
SM-47-4153P	5,500	1 (25.4)	-	1500 (2,034)	200~1200 (271~1627)	3/8"	1/2 (13)	7 (198)	9 (229)	8.55 (3.88)

* Recommended Air Pressure at 90 PSI (6.2 Bar)

* Max. Torque and Reverse Torque to be Tested by Removing Damping Material

Impact Wrenches

Features:

- **Composite** Motor Housing
- Handle Exhaust (Silencer)
- **Twin Hammer / Pin Clutch**
- Reverse : Full Power
- Forward : 3 Different Speeds

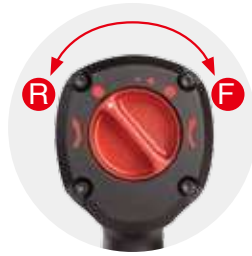

Patent No.

TW M453569 / D159426
Patent Pending in Multi-Countries



SM-43-4131P1
1/2" Impact Wrench
- Twin Hammer



SM-43-4131P2
1/2" Impact Wrench
- Pin Clutch



SM-43-4131PL
1/2" Impact Wrench
- with 2" Ext. Anvil
- Twin Hammer



SM-45-4151P
3/4" Impact Wrench
- Twin Hammer



SM-47-4151P
1" Impact Wrench
- Twin Hammer



SM-45-4151PL
3/4" Impact Wrench
- with 6" Ext. Anvil
- Twin Hammer



SM-47-4151PL
1" Impact Wrench
- with 6" Ext. Anvil
- Twin Hammer

Specifications :

Model No.	Free Speed (RPM)	Anvil Size Inch (mm)	Loosening Torque (Max.) Ft-lbs (Nm)	Maximum Torque Ft-lbs (Nm)	Working Torque Range Ft-lbs (Nm)	Air Inlet (NPT)	Hose Size ID Inch (mm)	Average Air Consumption CFM (L/Min)	Length Inch (mm)	Weight Lbs (Kg)
SM-43-4131P1	9,000	1/2 (13)	1,100 (1,492)	780 (1,054)	50~550 (68~746)	1/4"	3/8 (10)	4.4 (125)	7.3 (186)	4.58 (2.08)
SM-43-4131P2	8,000	1/2 (13)	-	780 (1,054)	50~550 (68~746)	1/4"	3/8 (10)	4.4 (125)	7.6 (192)	4.67 (2.12)
SM-43-4131PL	9,000	1/2 (13)	1,100 (1,492)	780 (1,054)	50~550 (68~746)	1/4"	3/8 (10)	4.4 (125)	9.4 (239)	4.89 (2.22)
SM-45-4151P	5,500	3/4 (19)	-	1,500 (2034)	200~1,200 (271~1,627)	3/8"	1/2 (13)	7 (198)	8.7 (220)	8.77 (3.98)
SM-47-4151P	5,500	1 (25.4)	-	1,500 (2034)	200~1,200 (271~1,627)	3/8"	1/2 (13)	7 (198)	9 (229)	9.01 (4.09)
SM-45-4151PL	5,500	3/4 (19)	-	1,500 (2034)	200~1,200 (271~1,627)	3/8"	1/2 (13)	7 (198)	14.7 (374)	9.81 (4.45)
SM-47-4151PL	5,500	1 (25.4)	-	1,500 (2034)	200~1,200 (271~1,627)	3/8"	1/2 (13)	7 (198)	15 (381)	10.95 (4.97)

* Recommended Air Pressure at 90 PSI (6.2 Bar)

* Max. Torque and Reverse Torque to be Tested by Removing Damping Material

Impact Wrenches

Features:

- Built-in Comfort Grip
- Handle Exhaust (Silencer)
- **Twin Hammer Clutch Mechanism**



SM-41-4017G
3/8" Impact Wrench



SM-43-4017G
1/2" Mini Impact Wrench



SM-43-4037G
1/2" Impact Wrench



SM-45-4057G
3/4" Impact Wrench



SM-47-4057G
1" Impact Wrench



SM-45-4057LG
3/4" Impact Wrench
- with 6" Ext. Anvil

SM-47-4057LG
1" Impact Wrench
- with 6" Ext. Anvil

Specifications:

Model No.	Free Speed (RPM)	Anvil Size Inch (mm)	Maximum Torque Ft-lbs (Nm)	Working Torque Range Ft-lbs (Nm)	Air Inlet (NPT)	Hose Size ID Inch (mm)	Average Air Consumption CFM (L/Min)	Length Inch (mm)	Weight Lbs (Kg)
SM-41-4017G	11,000	3/8 (10)	400 (542)	25~300 (34~407)	1/4"	3/8 (10)	5 (142)	6.1 (156)	3.5 (1.6)
SM-43-4017G	11,000	1/2 (13)	400 (542)	25~300 (34~407)	1/4"	3/8 (10)	5 (142)	6.1 (156)	3.5 (1.6)
SM-43-4037G	9,000	1/2 (13)	900 (1,220)	50~700 (68~949)	1/4"	3/8 (10)	6 (170)	7.3 (185)	6 (2.7)
SM-45-4057G	5,500	3/4 (19)	1,500 (2,034)	200~1,300 (271~1,763)	3/8"	1/2 (13)	7 (198)	8.7 (220)	10.1 (4.6)
SM-47-4057G	5,500	1 (25.4)	1,500 (2,034)	200~1,300 (271~1,763)	3/8"	1/2 (13)	7 (198)	9 (228)	11 (5)
SM-45-4057LG	5,500	3/4 (19)	1,500 (2,034)	200~1,300 (271~1,763)	3/8"	1/2 (13)	7 (198)	14.7 (373)	12.1 (5.5)
SM-47-4057LG	5,500	1 (25.4)	1,500 (2,034)	200~1,300 (271~1,763)	3/8"	1/2 (13)	7 (198)	15 (381)	13 (5.9)

* Recommended Air Pressure at 90 PSI (6.2 Bar)

* Max. Torque and Reverse Torque to be Tested by Removing Damping Material

1" Heavy Duty Impact Wrenches

Features:

- Side Support Handle for Better Control when Operate
- Handle with Inside Trigger
- with Steel Ring to Retain the Sockets
- **Twin Hammer Clutch / Pinless Clutch Mechanism**



SM-47-4071

1" Heavy Duty Impact Wrench

- Pinless Clutch
- Max. Torque : 2,200 Ft-lbs (2,983 Nm)
- Weight : 10.56 kgs



SM-47-4072

1" Heavy Duty Impact Wrench

- Twin Hammer
- Max. Torque : 2,500 Ft-lbs (3,390 Nm)
- Weight : 10 kgs



SM-47-4071L7

1" Heavy Duty Impact Wrench - Pinless Clutch

- Anvil Length : 7.6" (193 mm)
- Max. Torque : 2,200 Ft-lbs (2,983 Nm)
- Weight : 11.9 kgs

SM-47-4071L9

1" Heavy Duty Impact Wrench - Pinless Clutch

- Anvil Length : 9.6" (245 mm)
- Max. Torque : 2,200 Ft-lbs (2,983 Nm)
- Weight : 12.2 kgs



SM-47-4072L6

1" Heavy Duty Impact Wrench - Twin Hammer

- Anvil Length : 6.3" (159 mm)
- Max. Torque : 2,500 Ft-lbs (3,390 Nm)
- Weight : 10.9 kgs

SM-47-4072L8

1" Heavy Duty Impact Wrench - Twin Hammer

- Anvil Length : 8.3" (210 mm)
- Max. Torque : 2,500 Ft-lbs (3,390 Nm)
- Weight : 11 kgs



Specifications :

Model No.	Free Speed (RPM)	Anvil Size Inch (mm)	Maximum Torque Ft-lbs (Nm)	Working Torque Range Ft-lbs (Nm)	Air Inlet (NPT)	Hose Size ID Inch (mm)	Max. Air Consumption CFM (L/Min)	Length Inch (mm)	Weight Lbs (Kg)
SM-47-4071	5,000	1 (25.4)	2,200 (2,983)	400~1,650 (542~2,237)	1/2"	1/2 (13)	10 (282)	13.6 (346)	23.3 (10.56)
SM-47-4072	5,000	1 (25.4)	2,500 (3,390)	400~1,800 (542~2,441)	1/2"	1/2 (13)	10 (282)	16.2 (412)	22 (10)
SM-47-4071L7	5,000	1 (25.4)	2,200 (2,983)	400~1,650 (542~2,237)	1/2"	1/2 (13)	10 (282)	19.6 (497)	26.2 (11.9)
SM-47-4071L9	5,000	1 (25.4)	2,200 (2,983)	400~1,650 (542~2,237)	1/2"	1/2 (13)	10 (282)	21.6 (548)	26.9 (12.2)
SM-47-4072L6	5,000	1 (25.4)	2,500 (3,390)	400~1,800 (542~2,441)	1/2"	1/2 (13)	10 (282)	18.7 (476)	24 (10.9)
SM-47-4072L8	5,000	1 (25.4)	2,500 (3,390)	400~1,800 (542~2,441)	1/2"	1/2 (13)	10 (282)	20.7 (527)	24.3 (11)

* Recommended Air Pressure at 90 PSI (6.2 Bar)

* Max. Torque and Reverse Torque to be Tested by Removing Damping Material

1" Heavy Duty Impact Wrench Kit

Heavy Duty Series

Features:

- Side Support Handle for Better Control when Operate
- Handle with Inside Trigger
- with Steel Ring to Retain the Sockets
- **Twin Hammer Clutch / Pinless Clutch Mechanism**
- with Sockets Set : 27, 30, 32, 33, 35, 36, 38, 41 mm



SM-47-4071L7K

1" Heavy Duty Impact Wrench Kit - **Pinless Clutch**

- Anvil Length : 7.6" (193 mm)
- Max. Torque : 2,200 Ft-lbs (2,983 Nm)

SM-47-4071L9K

1" Heavy Duty Impact Wrench Kit - **Pinless Clutch**

- Anvil Length : 9.6" (245 mm)
- Max. Torque : 2,200 Ft-lbs (2,983 Nm)

Kit Includes:

- 1 pc SM-47-4071L7 or SM-47-4071L9
- 8 pcs Sockets Set
incl : 27, 30, 32, 33, 35, 36, 38, 41 mm
- 1 pc Blow Molded Case

SM-47-4072L6K

1" Heavy Duty Impact Wrench Kit - **Twin Hammer**

- Anvil Length : 6.3" (159 mm)
- Max. Torque : 2,500 Ft-lbs (3,390 Nm)

SM-47-4072L8K

1" Heavy Duty Impact Wrench Kit - **Twin Hammer**

- Anvil Length : 8.3" (210 mm)
- Max. Torque : 2,500 Ft-lbs (3,390 Nm)

Kit Includes:

- 1 pc SM-47-4072L6 or SM-47-4072L8
- 8 pcs Sockets Set
incl : 27, 30, 32, 33, 35, 36, 38, 41 mm
- 1 pc Blow Molded Case

Specifications :

Model No.	Free Speed (RPM)	Anvil Size Inch (mm)	Maximum Torque Ft-lbs (Nm)	Working Torque Range Ft-lbs (Nm)	Air Inlet (NPT)	Hose Size ID Inch (mm)	Max. Air Consumption CFM (L/Min)	Length Inch (mm)	Weight Lbs (Kg)
SM-47-4071L7	5,000	1 (25.4)	2,200 (2,983)	400~1,650 (542~2,237)	1/2"	1/2 (13)	10 (282)	19.6 (497)	26.2 (11.9)
SM-47-4071L9	5,000	1 (25.4)	2,200 (2,983)	400~1,650 (542~2,237)	1/2"	1/2 (13)	10 (282)	21.6 (548)	26.9 (12.2)
SM-47-4072L6	5,000	1 (25.4)	2,500 (3,390)	400~1,800 (542~2,441)	1/2"	1/2 (13)	10 (282)	18.7 (476)	24 (10.9)
SM-47-4072L8	5,000	1 (25.4)	2,500 (3,390)	400~1,800 (542~2,441)	1/2"	1/2 (13)	10 (282)	20.7 (527)	24.3 (11)

* Recommended Air Pressure at 90 PSI (6.2 Bar)

* Max. Torque and Reverse Torque to be Tested by Removing Damping Material

1" Light Duty Impact Wrenches

Features:

- Side Support Handle for Better Control when Operate
- Bended Handle with Inside Trigger
- with Steel Ring to Retain the Sockets
- **Twin Hammer Clutch Mechanism**
- **Lightweight**



▲ Inside Trigger



Crank Back Handle

Side Exhaust to Direct Exhaust Air away from the Side.



← Anvil Length →



▲ Safe Twist Handle Design

SM-47-4073

1" Impact Wrench

- Twin Hammer
- Max. Torque : 1,800 Ft-lbs (2,441 Nm)
- Weight : 6.5 kgs



SM-47-4073L7

1" Impact Wrench

- Twin Hammer
- Anvil Length : 7.1" (180 mm)
- Max. Torque : 1,800 Ft-lbs (2,441 Nm)
- Weight : 7.3 kgs

SM-47-4073L8

1" Impact Wrench

- Twin Hammer
- Anvil Length : 8.3" (210 mm)
- Max. Torque : 1,800 Ft-lbs (2,441 Nm)
- Weight : 7.5 kgs

SM-47-4073L7Q

1" Impact Wrench (Lower Noise)

- Twin Hammer
- Anvil Length : 7.1" (180 mm)
- Max. Torque : 1,600 Ft-lbs (2,170 Nm)
- Weight : 7.3 kgs

SM-47-4073L8Q

1" Impact Wrench (Lower Noise)

- Twin Hammer
- Anvil Length : 8.3" (210 mm)
- Max. Torque : 1,600 Ft-lbs (2,170 Nm)
- Weight : 7.5 kgs



Patent Pending in Multi-Countries

Specifications:

Model No.	Free Speed (RPM)	Anvil Size Inch (mm)	Maximum Torque Ft-lbs (Nm)	Working Torque Range Ft-lbs (Nm)	Air Inlet (NPT)	Hose Size ID Inch (mm)	Average Air Consumption CFM (L/Min)	Length Inch (mm)	Weight Lbs (Kg)	Noise Level dB(A)
SM-47-4073	6,000	1 (25.4)	1,800 (2,441)	200~1,500 (271~2,033)	1/2"	1/2 (13)	10 (282)	12.8 (324)	14.3 (6.5)	96
SM-47-4073L7	6,000	1 (25.4)	1,800 (2,441)	200~1,500 (271~2,033)	1/2"	1/2 (13)	10 (282)	18.3 (466)	16.1 (7.3)	96
SM-47-4073L8	6,000	1 (25.4)	1,800 (2,441)	200~1,500 (271~2,033)	1/2"	1/2 (13)	10 (282)	19.4 (492)	16.5 (7.5)	96
SM-47-4073L7Q	5,500	1 (25.4)	1,600 (2,170)	200~1,350 (271~1,831)	1/2"	1/2 (13)	10 (282)	18.3 (466)	16.1 (7.3)	89
SM-47-4073L8Q	5,500	1 (25.4)	1,600 (2,170)	200~1,350 (271~1,831)	1/2"	1/2 (13)	10 (282)	19.4 (492)	16.5 (7.5)	89

* Recommended Air Pressure at 90 PSI (6.2 Bar)

* Max. Torque and Reverse Torque to be Tested by Removing Damping Material

1" Light Duty Impact Wrenches

Features:

- Side Support Handle for Better Control when Operate
- with Steel Ring to Retain the Sockets
- **Twin Hammer Clutch Mechanism**
- **Lightweight**

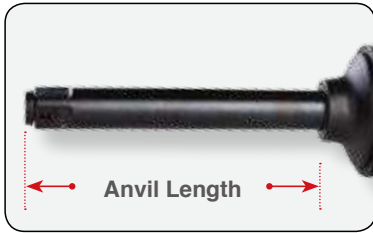

SM-47-4076

1" Impact Wrench

- Twin Hammer
- Max. Torque : 1,800 Ft-lbs (2,441 Nm)
- Weight : 6.3 kgs



SM-47-4076L7

1" Impact Wrench

- Twin Hammer
- Anvil Length : 7.3" (185 mm)
- Max. Torque : 1,800 Ft-lbs (2,441 Nm)
- Weight : 7.1 kgs



SM-47-4076L8

1" Impact Wrench

- Twin Hammer
- Anvil Length : 8.3" (210 mm)
- Max. Torque : 1,800 Ft-lbs (2,441 Nm)
- Weight : 7.2 kgs



Specifications:

Model No.	Free Speed (RPM)	Anvil Size Inch (mm)	Maximum Torque Ft-lbs (Nm)	Working Torque Range Ft-lbs (Nm)	Air Inlet (NPT)	Hose Size ID Inch (mm)	Average Air Consumption CFM (L/Min)	Length Inch (mm)	Weight Lbs (Kg)	Noise Level dB(A)
SM-47-4076	6,000	1 (25.4)	1,800 (2,441)	220~1,450 (300~1,965)	1/2"	1/2 (13)	10 (282)	14.9 (378)	13.9 (6.3)	90
SM-47-4076L7	6,000	1 (25.4)	1,800 (2,441)	220~1,450 (300~1,965)	1/2"	1/2 (13)	10 (282)	20.6 (522)	15.7 (7.1)	90
SM-47-4076L8	6,000	1 (25.4)	1,800 (2,441)	220~1,450 (300~1,965)	1/2"	1/2 (13)	10 (282)	21.5 (547)	15.9 (7.2)	90

* Recommended Air Pressure at 90 PSI (6.2 Bar)

* Max. Torque and Reverse Torque to be Tested by Removing Damping Material

1" Heavy Duty Impact Wrenches

Features:

- 1" Heavy Duty Impact Wrench
- **Twin Hammer Clutch Mechanism**
- Adjustable Side Handle
- 3 Position Power Setting in Forward and Reverse
- Handle Exhaust



**3 Position Power Setting
in Forward and Reverse**



Anvil Length

Accessories (Optional)

Exhaust Hose Assembly

EH-47-407457-11SUB

For SM-47-4075



SM-47-4075 1" Impact Wrench

- Max. Torque : 2,500 Ft-lbs (3,390 Nm)
- Weight : **9.9 kgs**



SM-47-4075L6 1" Impact Wrench

- Anvil Length : **6.3" (160 mm)**
- Max. Torque : 2,500 Ft-lbs (3,390 Nm)
- Weight : **10.7 kgs**



SM-47-4075L8 1" Impact Wrench

- Anvil Length : **8.3" (210 mm)**
- Max. Torque : 2,500 Ft-lbs (3,390 Nm)
- Weight : **11.1 kgs**

Specifications:

Model No.	Free Speed (RPM)	Anvil Size Inch (mm)	Maximum Torque Ft-lbs (Nm)	Working Torque Range Ft-lbs (Nm)	Air Inlet (NPT)	Hose Size ID Inch (mm)	Average Air Consumption CFM (L/Min)	Length Inch (mm)	Weight Lbs (Kg)
SM-47-4075	5,000	1 (25.4)	2,500 (3,390)	360~1,600 (488~2,169)	1/2"	1/2 (13)	10 (282)	11.4 (290)	21.8 (9.9)
SM-47-4075L6	5,000	1 (25.4)	2,500 (3,390)	360~1,600 (488~2,169)	1/2"	1/2 (13)	10 (282)	15.4 (391)	23.6 (10.7)
SM-47-4075L8	5,000	1 (25.4)	2,500 (3,390)	360~1,600 (488~2,169)	1/2"	1/2 (13)	10 (282)	17.4 (442)	24.5 (11.1)

* Recommended Air Pressure at 90 PSI (6.2 Bar)

* Max. Torque and Reverse Torque to be Tested by Removing Damping Material

1" Light Duty Impact Wrenches

Features:

- 1" Heavy Duty Impact Wrench
- **Twin Hammer Clutch Mechanism**
- Adjustable Side Handle
- 3 Position Power Setting in Forward and Reverse
- Handle Exhaust



**3 Position Power Setting
in Forward and Reverse**



Anvil Length

Accessories (Optional)

Exhaust Hose Assembly

EH-47-407457-11SUB

For SM-47-4075



SM-47-4074

1" Impact Wrench

- Max. Torque : 1,800 Ft-lbs (2,441 Nm)
- Weight : 6.3 kgs



SM-47-4074L7

1" Impact Wrench

- Anvil Length : 7.3" (185 mm)
- Max. Torque : 1,800 Ft-lbs (2,441 Nm)
- Weight : 7.1 kgs



SM-47-4074L8

1" Impact Wrench

- Anvil Length : 8.3" (210 mm)
- Max. Torque : 1,800 Ft-lbs (2,441 Nm)
- Weight : 7.3 kgs

Specifications:

Model No.	Free Speed (RPM)	Anvil Size Inch (mm)	Maximum Torque Ft-lbs (Nm)	Working Torque Range Ft-lbs (Nm)	Air Inlet (NPT)	Hose Size ID Inch (mm)	Average Air Consumption CFM (L/Min)	Length Inch (mm)	Weight Lbs (Kg)
SM-47-4074	6,000	1 (25.4)	1,800 (2,441)	220~1,450 (300~1,965)	1/2"	1/2 (13)	10 (282)	9.7 (247)	13.9 (6.3)
SM-47-4074L7	6,000	1 (25.4)	1,800 (2,441)	220~1,450 (300~1,965)	1/2"	1/2 (13)	10 (282)	15.4 (390)	15.7 (7.1)
SM-47-4074L8	6,000	1 (25.4)	1,800 (2,441)	220~1,450 (300~1,965)	1/2"	1/2 (13)	10 (282)	16.3 (415)	16.1 (7.3)

* Recommended Air Pressure at 90 PSI (6.2 Bar)

* Max. Torque and Reverse Torque to be Tested by Removing Damping Material

Super Impact Wrench

Features:

- Composite Motor Housing
- Handle Exhaust
- Twin Hammer Clutch
- 7 Rotor Vanes - Composite
- Variable Speed Trigger
- BIAS Air Motor
- Forward : 3 Different Speeds
- Reverse : Full Power

SM-43-4038P

1/2" Super Impact Wrench



SM-43-4038PL

1/2" Impact Wrench
- with 2" Ext. Anvil



Specifications:

Model No.	Free Speed (RPM)	Anvil Size Inch (mm)	Loosening Torque (Max.) Ft-lbs (Nm)	Maximum Torque Ft-lbs (Nm)	Working Torque Range Ft-lbs (Nm)	Air Inlet (NPT)	Hose Size ID Inch (mm)	Average Air Consumption CFM (L/Min)	Length Inch (mm)	Weight Lbs (Kg)	Noise Level dB(A)
SM-43-4038P	7,500	1/2 (13)	1,300 (1,756)	950 (1,288)	50~580 (68~786)	1/4"	3/8 (10)	4 (113)	7.3 (185)	4.3 (1.94)	89
SM-43-4038PL	7,500	1/2 (13)	1,300 (1,756)	950 (1,288)	50~580 (68~786)	1/4"	3/8 (10)	4 (113)	9.4 (238)	4.4 (2)	89

* Recommended Air Pressure at 90 PSI (6.2 Bar)

* Max. Torque and Reverse Torque to be Tested by Removing Damping Material

Take A Load Off Users' Backs With Our Suspending Stands

Features:

Auto mechanic, tire shop workers and others who need to manipulate heavy objects will immediately recognize the value of this product. By suspending air tools and other items in midair, it protects users' backs and saves their time and strength. For details, please contact us today.



Demonstration on website :
<http://www.sunmatch.com/video.html>



Patent No.

TAIWAN No. 158779
Patents pending in other countries

Specifications:

Model No.	Suspending Capacity Kg (Lbs)	Height Cm (Inch)	Gross Weight Kg (Lbs)
SM-0915	9~15 (19~33)	168 (66)	29 (63)
SM-1522	15~22 (33~48)	168 (66)	29 (63)

SM-0915

Suspending Stand
- Capacity 9 ~ 15 Kgs (19 ~ 33 Lbs)

SM-1522

Suspending Stand
- Capacity 15 ~ 22 Kgs (33 ~ 48 Lbs)

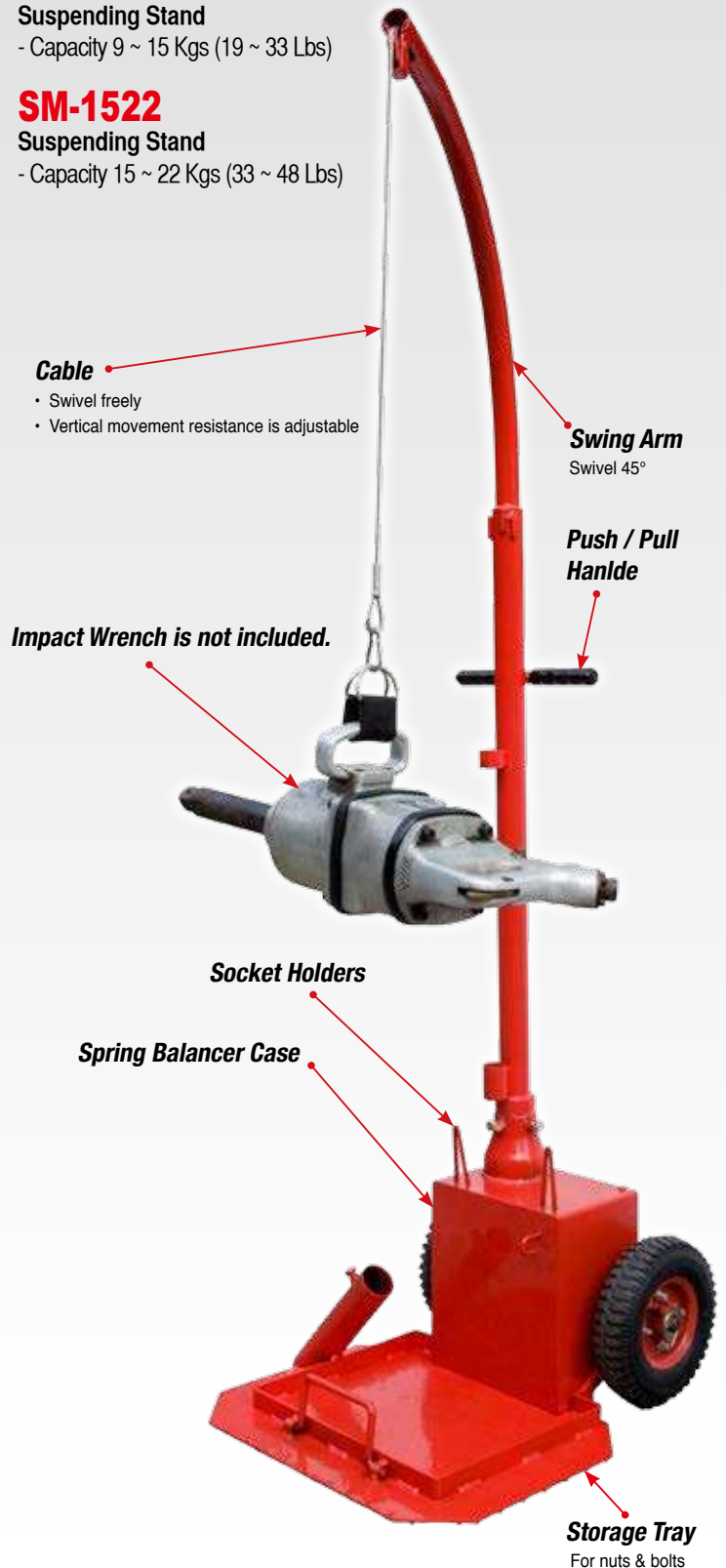



Ratchet Wrenches & Impact Ratchet Wrenches

Features:

- Needle Bearing
- Thick Wall Ratchet Head
- Ball Bearing
- Cushioned Grip
- Rear Exhaust

SM-32-3124A

1/4" Mini Ratchet Wrench
- Full-Cage Gear Design

SM-33-3124A

3/8" Mini Ratchet Wrench
- Full-Cage Gear Design



SM-33-3123A

3/8" Air Ratchet Wrench

SM-34-3123A

1/2" Air Ratchet Wrench



Features:

- **Pin Clutch Impact Mechanism** which Eliminates Torque Reaction, Saving Your Knuckles
- Three Times Faster than Standard Ratchets
- **Maximum Torque 90 ft.lbs (122 Nm)**

SM-33-3117A

3/8" Impact Ratchet Wrench

SM-34-3117A

1/2" Impact Ratchet Wrench

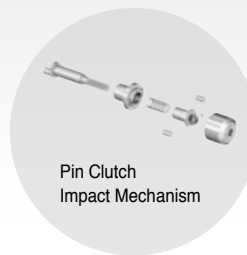

Specifications:

Model No.	Free Speed (RPM)	Anvil Size Inch (mm)	Maximum Torque Ft-lbs (Nm)	Working Torque Range Ft-lbs (Nm)	Air Inlet (NPT)	Hose Size ID Inch (mm)	Air Consumption CFM (L/Min)	Length Inch (mm)	Weight Lbs (Kg)	Noise Level dB(A)
SM-32-3124A	200	1/4 (6)	30 (41)	5~30 (7~41)	1/4	3/8 (10)	4 (113)	7.7 (196)	1.1 (0.5)	80
SM-33-3124A	200	3/8 (10)	30 (41)	5~30 (7~41)	1/4	3/8 (10)	4 (113)	7.7 (196)	1.1 (0.5)	80
SM-33-3123A	150	3/8 (10)	50 (68)	10~50 (14~68)	1/4	3/8 (10)	4 (113)	10.1 (256)	2.6 (1.2)	86
SM-34-3123A	150	1/2 (13)	50 (68)	10~50 (14~68)	1/4	3/8 (10)	4 (113)	10.1 (256)	2.6 (1.2)	86
SM-33-3117A	600	3/8 (10)	90 (122)	20~70 (27~95)	1/4	3/8 (10)	4 (113)	11 (280)	2.82 (1.28)	90
SM-34-3117A	600	1/2 (13)	90 (122)	20~70 (27~95)	1/4	3/8 (10)	4 (113)	11 (280)	2.82 (1.28)	90

* Recommended Air Pressure at 90 PSI (6.2 Bar)

Impact Ratchet Wrenches

Features:

- **Pin Clutch Impact Mechanism** which Eliminates Torque Reaction, Saving Your Knuckles
- Three Times Faster than Standard Ratchets
- **Maximum Torque 90 ft.lbs (122 Nm)**



Stubby Ratchet Wrenches

Features:

- **Composite Motor Housing**
- Short & Compact Size
- **Available Wobble Anvil in 3/8" Anvil Size**
- Rear Exhaust
- **Patented Silencer 85 dB(A)**



Specifications:

Model No.	Free Speed (RPM)	Anvil Size Inch (mm)	Maximum Torque Ft-lbs (Nm)	Air Inlet (NPT)	Hose Size ID Inch (mm)	Air Consumption CFM (L/Min)	Length Inch (mm)	Weight Lbs (Kg)	Noise Level dB(A)
SM-33-3117	600	3/8 (9.5)	90 (122)	1/4"	3/8 (10)	4 (113)	11 (280)	2.82 (1.28)	90
SM-34-3117	600	1/2 (12.7)	90 (122)	1/4"	3/8 (10)	4 (113)	11 (280)	2.82 (1.28)	90
SM-32-3015	350	1/4 (6)	30 (40.7)	1/4"	3/8 (10)	4 (113)	5.2 (133)	1.1 (0.5)	85
SM-33-3015	350	3/8 (10)	30 (40.7)	1/4"	3/8 (10)	4 (113)	5.2 (133)	1.1 (0.5)	85

* Recommended Air Pressure at 90 PSI (6.2 Bar)

Multi-Function Ratchet Wrench

Features:

- Composite Motor Housing
- **1/4" & 3/8" Anvil Convertable**
- Slim, Compact Head Design
- Rear Exhaust
- **Patented Silencer 85 dB(A)**

Patent No.

TW M345679
Patent Pending in Multi-Countries

SM-32-3016 Multi-Function Ratchet Wrench



SM-32-3016K Multi-Function Ratchet Wrench Kit



#32-301640-11
1/4" & 3/8" Anvil



#32-301642-11
3/8" Anvil &
1/4" Bit Holder



(Optional)

#32-301641-11
1/4" Bit Holder



#32-301643-11
1/4" Anvil &
1/4" Bit Holder



(Optional)

#32-301620-11



#32-301620-12



#32-301621-11



#32-301621-12



Screwdriver Bits



SM-32-3016
Multi-Function Ratchet
Wrench

Kit includes:

- 1 pc SM-32-3016 Ratchet Wrench with open head
- 1 pc Reversible Ratchet Head 1/4" + 3/8"
- 1 pc 1/4" Screwdriver Bit holder
- 1 pc 1/4" Dr. Ergonomic Ratchet Handle (Forward/Fixed/Reverse)
- 10 pcs 1/4" Sockets Set (incl: 5.5, 6, 7, 8, 9, 10, 11, 12, 13, 14mm)
- 1 pc 1/4" Dr. Universal Joint
- 1 pc 1/4" Dr. Quick Release Bit Adapter
- 1 pc 100mm Quick Release Extension Bar
- 1 pc 1/4" Dr. Spinner Handle
- 21 pcs 25mm Insert Bit:
 - PH: 1, 2
 - PZ: 1, 2, 3
 - FD: 4, 5.5, 6.5, 8mm
 - Hex: 3, 4, 5, 6, 7mm
 - TX (Tamper)-Torx Security: 10, 15, 20, 25, 27, 30, 40mm

SM-32-3016K2 Multi-Function Ratchet Wrench Kit



Specifications:

Model No.	Free Speed (RPM)	Anvil Size Inch (mm)	Maximum Torque Ft-lbs (Nm)	Air Inlet (NPT)	Hose Size ID Inch (mm)	Air Consumption CFM (L/Min)	Length Inch (mm)	Weight Lbs (Kg)	Noise Level dB(A)
SM-32-3016	850	1/4 & 3/8 (6 & 10)	30 (40.7)	1/4"	3/8 (10)	4 (113)	6.1 (155)	1.1 (0.5)	85

* Recommended Air Pressure at 90 PSI (6.2 Bar)

Features:

- Needle Bearing
- Thick Wall Ratchet Head
- Ball Bearing
- Cushioned Grip
- **New Air Regulator**
- 360° Swivel Air Inlet (Only for SM-32-3024, SM-33-3024, SM-33-3023 & SM-34-3023)
- Rear Exhaust
- **Low Noise 79 dB(A)**

SM-32-3022

1/4" Baby Ratchet Wrench
- Full-Cage Gear Design

SM-33-3022

3/8" Baby Ratchet Wrench
- Full-Cage Gear Design



Quiet Series



▲ Operation of Ratchet Wrench

SM-32-3024

1/4" Mini Ratchet Wrench
- Full-Cage Gear Design

SM-33-3024

3/8" Mini Ratchet Wrench
- Full-Cage Gear Design



SM-33-3023

3/8" Air Ratchet Wrench

SM-34-3023

1/2" Air Ratchet Wrench



SM-33-3023K

3/8" Air Ratchet Wrench Kit

SM-34-3023K

1/2" Air Ratchet Wrench Kit

Specifications:

Model No.	Free Speed (RPM)	Anvil Size Inch (mm)	Maximum Torque Ft-lbs (Nm)	Working Torque Range Ft-lbs (Nm)	Air Inlet (NPT)	Hose Size ID Inch (mm)	Air Consumption CFM (L/Min)	Length Inch (mm)	Weight Lbs (Kg)	Noise Level dB(A)
SM-32-3022	200	1/4 (6)	30 (41)	5~30 (7~41)	1/4"	3/8 (10)	4 (113)	7 (177)	1.1 (0.5)	79
SM-33-3022	200	3/8 (10)	30 (41)	5~30 (7~41)	1/4"	3/8 (10)	4 (113)	7 (177)	1.1 (0.5)	79
SM-32-3024	200	1/4 (6)	30 (41)	5~30 (7~41)	1/4"	3/8 (10)	4 (113)	7.7 (196)	1.1 (0.5)	79
SM-33-3024	200	3/8 (10)	30 (41)	5~30 (7~41)	1/4"	3/8 (10)	4 (113)	7.7 (196)	1.1 (0.5)	79
SM-33-3023	150	3/8 (10)	50 (68)	10~50 (14~68)	1/4"	3/8 (10)	4 (113)	10.1 (256)	2.6 (1.2)	79
SM-34-3023	150	1/2 (13)	50 (68)	10~50 (14~68)	1/4"	3/8 (10)	4 (113)	10.1 (256)	2.6 (1.2)	79

* Recommended Air Pressure at 90 PSI (6.2 Bar)

Ratchet Wrenches



▲ Operation of Ratchet Wrench

Features:

- Needle Bearing
- Thick Wall Ratchet Head
- Ball Bearing
- Cushioned Grip
- New Air Regulator
- Throttle Lever Pressed to Flat
- Rotating Air Inlet
- **Rotating Rear Exhaust**
- **Low Noise 79 dB(A)**

SM-32-3012

1/4" Baby Ratchet Wrench
- Full-Cage Gear Design

SM-33-3012

3/8" Baby Ratchet Wrench
- Full-Cage Gear Design



Quiet Series

SM-32-3014

1/4" Mini Ratchet Wrench
- Full-Cage Gear Design

SM-33-3014

3/8" Mini Ratchet Wrench
- Full-Cage Gear Design



SM-33-3013

3/8" Air Ratchet Wrench

SM-34-3013

1/2" Air Ratchet Wrench



Rotating Air Inlet and Exhaust

▲ Rotating Rear Exhaust is not Available for U.S.A.

Patent No.

US D525,501 S
DE 20 2007 002 509 U1
TW D112522 / D112524 / M316779
Patent Pending in Multi-Countries

Specifications:

Model No.	Free Speed (RPM)	Anvil Size Inch (mm)	Maximum Torque Ft-lbs (Nm)	Working Torque Range Ft-lbs (Nm)	Air Inlet (NPT)	Hose Size ID Inch (mm)	Air Consumption CFM (L/Min)	Length Inch (mm)	Weight Lbs (Kg)	Noise Level dB(A)
SM-32-3012	200	1/4 (6)	30 (41)	5~30 (7~41)	1/4"	3/8 (10)	4 (113)	7 (177)	1.3 (0.6)	79
SM-33-3012	200	3/8 (10)	30 (41)	5~30 (7~41)	1/4"	3/8 (10)	4 (113)	7 (177)	1.3 (0.6)	79
SM-32-3014	200	1/4 (6)	30 (41)	5~30 (7~41)	1/4"	3/8 (10)	4 (113)	7.7 (196)	1.3 (0.6)	79
SM-33-3014	200	3/8 (10)	30 (41)	5~30 (7~41)	1/4"	3/8 (10)	4 (113)	7.7 (196)	1.3 (0.6)	79
SM-33-3013	150	3/8 (10)	50 (68)	10~50 (14~68)	1/4"	3/8 (10)	4 (113)	10.1 (256)	2.6 (1.2)	79
SM-34-3013	150	1/2 (13)	50 (68)	10~50 (14~68)	1/4"	3/8 (10)	4 (113)	10.1 (256)	2.6 (1.2)	79

* Recommended Air Pressure at 90 PSI (6.2 Bar)



SUNMATCH
Professional Pneumatic Tools

Utility **Surface Blaster**

One Tool with Multi-Functions:

Wire Brush

(With wire brushes)

Rubber Eraser

(Patented)

Stripping Tool

(Single or double black wheels)

Patent No.

US 7,155,028 B1 / US 1,147,550 B2 / US D549,285 S / US D521,334 S / US D516,260 S

US 6,912,755 B2 / US 7,578,730 B2

DE 20 2005 007 270.2 / DE 20 2005 007 271.0 / DE 20 2005 002 317.5 / DE 20 2006 013 546.4

DE 20 2007 014 143 U1 / DE 203 14 978 U1 / DE 10 2007 048 480 B3

EU 000299052-0001

TW D113421 / D108995/ D109389/ M240301/ M270876 / M270877 / M257263 / M272622

M274199 / M275067 / M275057 / M280265 / M281768 / M305733 / M330154

Patent Pending in Multi-Countries



Utility Surface Blaster

Features:

- Different Type Wheels
(For the Preparation of Metal Surfaces Prior to Remedial Work)
- Safety Guard (Protect User from Debris / Sparks)
- **Adaptor (Patented)**
- **Rubber Eraser (Patented)**
- Safety Throttle Lever
- Rear Exhaust
- **Low Noise 83 dB(A)**



Wire Brush
(With wire brushes)



Rubber Eraser
(Two different type of rubber wheels)



Black Stripping
(Single or double black wheels)

SM-6903 Utility Surface Blaster (Tool Only)



Multi-Functions

SM-6902 Utility Surface Blaster (Tool Only)



Patent No.

US 7,155,028 B1 / US 1,147,550 B2 / US D549,285 S / US D521,334 S / US D516,260 S / US 6,912,755 B2 / US 7,578,730 B2
 DE 20 2005 007 270.2 / DE 20 2005 007 271.0 / DE 20 2005 002 317.5 / DE 20 2006 013 546.4
 DE 20 2007 014 143 U1 / DE 203 14 978 U 1 / DE 10 2007 048 480 B3
 EU 000299052-0001
 TW D113421 / D108995/ D109389/ M240301/ M270876 / M270877 / M257263 / M272622
 M274199 / M275067 / M275057 / M280265 / M281768 / M305733 / M330154
 Patent Pending in Multi-Countries

Specifications:

Model No.	Free Speed (RPM)	Air Inlet (NPT)	Hose Size ID Inch (mm)	Air Consumption CFM (L/Min)	Length Inch (mm)	Weight Lbs (Kg)	Noise Level dB(A)
SM-6902	3,500	1/4"	3/8 (10)	3.9 (110)	10.7 (272)	2.6 (1.2)	83
SM-6903	3,500	1/4"	3/8 (10)	3.9 (110)	10.7 (272)	2.6 (1.2)	83

* Recommended Air Pressure at 90 PSI (6.2 Bar)

Utility Surface Blaster Assembly

SM-6902K & SM-6903K

Utility Surface Blaster Kit

Includes:

- 1 pc Utility Surface Blaster
- 1 pc Blow Case

Accessories (Optional):

- #0511 11mm Wire Brush (Fine)
- #0523 23mm Wire Brush (Fine)
- #0711 11mm Wire Brush (Coarse)
- #0723 23mm Wire Brush (Coarse)
- SA-6902RW Rubber Eraser
- or SA-6903RW Rubber Eraser
- SA-6902RWW Water Based Paint Rubber Eraser
- or SA-6903RWW Water Based Paint Rubber Eraser
- SA-6902RH Adaptor for Rubber Eraser & 23mm Wire Brush
- or SA-6903RH Adaptor for Rubber Eraser & 23mm Wire Brush
- SA-6902WH Adaptor for 11mm Wire Brush
- or SA-6903WH Adaptor for 11mm Wire Brush
- SA-6902BW Black Strip Wheels (up to 6 pcs)
- SA-6902BHS Adaptor for Single Black Strip Wheel
- SA-6902BHD Adaptor for Double Black Strip Wheels



#0511
11mm Wire Brush (Fine)



#0711
11mm Wire Brush (Coarse)



#0523
23mm Wire Brush (Fine)



#0723
23mm Wire Brush (Coarse)



SA-6902BHS
Adaptor for Single Black Strip Wheel



SA-6902BHD
Adaptor for Double Black Strip Wheels



SA-6902BW
Black Strip Wheel

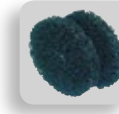

SA-6902BW
Double Black Strip Wheels



SA-6902WH *Patented*
SA-6903WH
Adaptor for 11mm Wire Brush



SA-6902RH *Patented*
SA-6903RH
Adaptor for Rubber Eraser or 23mm Brush



SA-6902RW *Patented*
SA-6903RW
Rubber Eraser



SA-6902RWW *Patented*
SA-6903RWW
Water Based Paint Rubber Eraser



SM-6902K
Utility Surface Blaster Kit



SM-6903K
Utility Surface Blaster Kit

Black Stripping Tool

Features:

- Easily Attached onto Tool with Patented Adaptor
- **Quickly Change to 1 pc or 2 pcs Black Wheels for Stripping Job**
- Excellent for Cleaning Welds, Coating, Adhesive and Rust



Stripping Tool
(Single black wheel)



Stripping Tool
(Double black wheels)

Utility Surface Blaster

▼ Optional Accessories



#0511
11mm Wire Brush
(Fine)



#0711
11mm Wire Brush
(Coarse)



#0523
23mm Wire Brush
(Fine)



#0723
23mm Wire Brush
(Coarse)



SA-6902WH
SA-6903WH
Adaptor for 11mm Wire
Brush



SA-6902RH
SA-6903RH
Adaptor for Rubber
Eraser or 23mm Brush



SA-6902RW
SA-6903RW
Rubber Eraser

SM-6902K-7

Utility Surface Blaster Kit - Seven Pieces onto One

Includes:

Accessories (Optional):

- SM-6902 Utility Surface Blaster (3,500 RPM)
- #0511 11mm Wire Brush (Fine)
- #0523 23mm Wire Brush (Fine)
- #0711 11mm Wire Brush (Coarse)
- #0723 23mm Wire Brush (Coarse)
- SA-6902RW Rubber Eraser
- or SA-6903RW Rubber Eraser
- SA-6902RH Adaptor for Rubber Eraser & 23mm Wire Brush
- or SA-6903RH Adaptor for Rubber Eraser & 23mm Wire Brush
- SA-6902WH Adaptor for 11mm Wire Brush
- or SA-6903WH Adaptor for 11mm Wire Brush

SM-6902

Utility Surface Blaster (Tool Only)



Everything in a carton box



▲ The White Box for SM-6902K-7

Specifications:

Model No.	Free Speed (RPM)	Air Inlet (NPT)	Hose Size ID Inch (mm)	Air Consumption CFM (L/Min)	Length Inch (mm)	Weight Lbs (Kg)	Noise Level dB(A)
SM-6902	3,500	1/4"	3/8 (10)	3.9 (110)	11 (280)	2.6 (1.2)	83

* Recommended Air Pressure at 90 PSI (6.2 Bar)

Utility Surface Blaster

SM-6903KF

Utility Surface Blaster Kit

Includes:

Accessories (Optional):

- 1 pc SM-6903 Utility Surface Blaster (3,500 RPM)
- 1 pc #0511 11mm Wire Brush (Fine)
- 1 pc #0523 23mm Wire Brush (Fine)
- 1 pc #0711 11mm Wire Brush (Coarse)
- 1 pc #0723 23mm Wire Brush (Coarse)
- 1 pc SA-6903RW Rubber Eraser
- 1 pc SA-6903RWW Water Based Paint Rubber Eraser
- 1 pc SA-6903RH Adaptor for Rubber Eraser & 23mm Wire Brush
- 1 pc SA-6903WH Adaptor for 11mm Wire Brush



Wire Brush
(With wire brushes)



Rubber Eraser
(Two different type of rubber erasers)



SM-6903
Utility Surface Blaster (Tool Only)

SM-6903KF

Utility Surface Blaster Kit



Multi-Functions

▼ Optional Accessories



#0511
11mm Wire Brush (Fine)

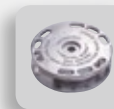

SA-6903WH *Patented*
Adaptor for 11mm Wire Brush



#0711
11mm Wire Brush (Coarse)



SA-6903RH *Patented*
Adaptor for Rubber Eraser or 23mm Brush



#0523
23mm Wire Brush (Fine)



SA-6903RW *Patented*
Rubber Eraser



#0723
23mm Wire Brush (Coarse)



SA-6903RWW *Patented*
Water Based Paint Rubber Eraser

Specifications:

Model No.	Free Speed (RPM)	Air Inlet (NPT)	Hose Size ID Inch (mm)	Air Consumption CFM (L/Min)	Length Inch (mm)	Weight Lbs (Kg)	Noise Level dB(A)
SM-6903	3,500	1/4"	3/8 (10)	3.9 (110)	11 (280)	2.6 (1.2)	83

* Recommended Air Pressure at 90 PSI (6.2 Bar)



Die Grinders & Cut-Off Tool

Features:

- Built-in Composite Grip
- Safety Throttle Lever
- Rear Exhaust with Silencer
- **0.3 HP Motor**



SM-53-5300

1/4" Mini Die Grinder
- 0.3 HP



SM-52-5300

1/4" 90° Angle Die Grinder
- 0.3 HP



SM-55-5300

1/4" 115° Angle Die Grinder
- 0.3 HP



SM-5E-5300

1/4" Extended Die Grinder
- 0.3 HP



Specifications:

Model No.	Free Speed (RPM)	Collet Size Inch (mm)	Air Inlet (NPT)	Hose Size ID Inch (mm)	Air Consumption CFM (L/Min)	Length Inch (mm)	Weight Lbs (Kg)	Power HP (Kw)	Noise Level dB(A)
SM-53-5300	25,000	1/4 (6) or 1/8 (3)	1/4"	3/8 (10)	4 (113)	6.3 (161)	0.9 (0.4)	0.3 (0.2)	84
SM-52-5300	20,000	1/4 (6) or 1/8 (3)	1/4"	3/8 (10)	4 (113)	6.5 (165)	1.1 (0.5)	0.3 (0.2)	84
SM-55-5300	20,000	1/4 (6) or 1/8 (3)	1/4"	3/8 (10)	4 (113)	7.8 (198)	1.1 (0.5)	0.3 (0.2)	84
SM-5E-5300	25,000	1/4 (6) or 1/8 (3)	1/4"	3/8 (10)	4 (113)	10.1 (256)	1.5 (0.7)	0.3 (0.2)	84

* Recommended Air Pressure at 90 PSI (6.2 Bar)

Family Looking Tools

Features:

- Built-in Composite Grip
- Safety Throttle Lever
- Rear Exhaust with Silencer
- **0.5 HP Motor**

SM-51-5100

1/4" Die Grinder - Full Size
- 0.5 HP



SM-54-5100

1/4" Die Grinder
- 0.5 HP



▲ Full-Cage Gear Design

SM-5F-5100

1/4" Extended Die Grinder
- 0.5 HP



SM-6K-5100

Pinstripe Removal Tool
- 0.5 HP



▲ Pad Size 3-1/2"

SM-29-5100

Straight Air Shear
- 0.5 HP



▲ Cutting Capacity Steel 1.2mm

SM-6F-5100

Low Speed Tire Buffer
- 0.5 HP



SM-5J-5100

3" Cut-Off Tool
- 0.5 HP



SM-76-5100

3/8" Straight Air Drill
- 0.5 HP



SM-7A-5100

SM-7B-5100
3/8" Straight Air Drill
- 0.5 HP



▲ Full-Cage Gear Design

SM-7L-5100

3/8" High Speed Straight Air Drill
- 0.5 HP



Specifications:

Model No.	Free Speed (RPM)	Collet (or Chuck) Size Inch (mm)	Air Inlet (NPT)	Hose Size ID Inch (mm)	Air Consumption CFM (L/Min)	Length Inch (mm)	Weight Lbs (Kg)	Power HP (Kw)	Noise Level dB(A)
SM-51-5100	20,000	1/4 (6)	1/4"	3/8 (10)	4 (113)	7.5 (190)	1.5 (0.7)	0.5 (0.4)	84
SM-54-5100	4,000	1/4 (6)	1/4"	3/8 (10)	4 (113)	8.8 (223)	2.0 (0.9)	0.5 (0.4)	84
SM-5F-5100	20,000	1/4 (6)	1/4"	3/8 (10)	4 (113)	13.7 (348)	3.0 (1.4)	0.5 (0.4)	84
SM-6K-5100	4,000	-	1/4"	3/8 (10)	4 (113)	8.3 (210)	2.0 (0.9)	0.5 (0.4)	84
SM-6F-5100	2,500	-	1/4"	3/8 (10)	4 (113)	10 (255)	2.6 (1.2)	0.5 (0.4)	84
SM-29-5100	2,500	-	1/4"	3/8 (10)	4 (113)	10.6 (268)	2.6 (1.2)	0.5 (0.4)	84
SM-5J-5100	20,000	-	1/4"	3/8 (10)	4 (113)	8.1 (205)	1.8 (0.8)	0.5 (0.4)	84
SM-76-5100	2,500	3/8 (10)	1/4"	3/8 (10)	4 (113)	9.1 (231)	2.4 (1.1)	0.5 (0.4)	84
SM-7A-5100	2,500	3/8 (10)	1/4"	3/8 (10)	4 (113)	8.9 (225)	2.2 (1.0)	0.5 (0.4)	84
SM-7B-5100	4,000	3/8 (10)	1/4"	3/8 (10)	4 (113)	8.9 (225)	2.2 (1.0)	0.5 (0.4)	84
SM-7L-5100	20,000	3/8 (10)	1/4"	3/8 (10)	4 (113)	8.6 (218)	1.8 (0.8)	0.5 (0.4)	84

* Recommended Air Pressure at 90 PSI (6.2 Bar)

SM-50-240N

Die Grinder (24,000 RPM)
- Side Exhaust



- Built-in Comfort Grip

SM-50-241N

Die Grinder (24,000 RPM)
- Front Exhaust

SM-50-240S

Die Grinder (24,000 RPM)
- Side Exhaust



- Safety Throttle Lever
- Built-in Comfort Grip

SM-50-241S

Die Grinder (24,000 RPM)
- Front Exhaust

SM-50-250N

Die Grinder (24,000 RPM)
- Side Exhaust



- Built-in Comfort Grip

SM-50-250R

Die Grinder (24,000 RPM)
- Side Exhaust



- Ring Throttle
- Built-in Comfort Grip

SM-50-250S

Die Grinder (24,000 RPM)
- Side Exhaust



- Safety Throttle Lever
- Built-in Comfort Grip

SM-50-290N

Die Grinder (24,000 RPM)
- Side Exhaust

SM-50-291N

Die Grinder (24,000 RPM)
- Front Exhaust



SM-50-280R

Die Grinder (24,000 RPM)
- Side Exhaust

SM-50-281R

Die Grinder (24,000 RPM)
- Front Exhaust



- Ring Throttle

SM-50-290S

Die Grinder (24,000 RPM)
- Side Exhaust

SM-50-291S

Die Grinder (24,000 RPM)
- Front Exhaust



- Safety Throttle Lever

SM-5E-260N

Extended Die Grinder (24,000 RPM)
- Side Exhaust

SM-5E-261N

Extended Die Grinder (24,000 RPM)
- Front Exhaust



- Steel Housing

SM-5E-260R

Extended Die Grinder (24,000 RPM)
- Side Exhaust

SM-5E-261R

Extended Die Grinder (24,000 RPM)
- Front Exhaust



- Ring Throttle
- Steel Housing

SM-5E-260S

Extended Die Grinder (24,000 RPM)
- Side Exhaust

SM-5E-261S

Extended Die Grinder (24,000 RPM)
- Front Exhaust



- Safety Throttle Lever
- Steel Housing

Specifications:

Model No.	Throttle Type	Free Speed (RPM)	Air Inlet	Hose Size ID Inch (mm)	Power HP (Watt)	Max. Diameter of Mounted Point Inch (mm)	Max. Diameter of Carbide Burrs Inch (mm)	Collet Size Inch (mm)	Max. Air Cons. (m ³ /Min)	Length Inch (mm)	Weight Lbs (Kg)	Noise Level dB(A)
SM-50-240N	Lever	24,000	1/4"	3/8 (10)	0.35 (257)	1 (25)	1/2 (13)	1/4 (6)	0.4	6.8 (173)	1.16 (0.53)	83
SM-50-241N	Lever	24,000	1/4"	3/8 (10)	0.35 (257)	1 (25)	1/2 (13)	1/4 (6)	0.4	6.8 (173)	1.16 (0.53)	83
SM-50-240S	Lever	24,000	1/4"	3/8 (10)	0.35 (257)	1 (25)	1/2 (13)	1/4 (6)	0.4	6.8 (173)	1.21 (0.55)	83
SM-50-241S	Lever	24,000	1/4"	3/8 (10)	0.35 (257)	1 (25)	1/2 (13)	1/4 (6)	0.4	6.8 (172)	1.21 (0.55)	83
SM-50-250N	Lever	24,000	1/4"	3/8 (10)	0.35 (257)	1 (25)	1/2 (13)	1/4 (6)	0.4	7.6 (194)	1.65 (0.72)	83
SM-50-250S	Lever	24,000	1/4"	3/8 (10)	0.35 (257)	1 (25)	1/2 (13)	1/4 (6)	0.4	7.6 (194)	1.65 (0.75)	83
SM-50-250R	Ring	24,000	1/4"	3/8 (10)	0.35 (257)	1 (25)	1/2 (13)	1/4 (6)	0.4	8 (203)	1.67 (0.76)	83
SM-50-280R	Ring	24,000	1/4"	3/8 (10))	0.35 (257)	1 (25)	1/2 (13)	1/4 (6)	0.4	6.7 (169)	1.23 (0.56)	83
SM-50-281R	Ring	24,000	1/4"	3/8 (10)	0.35 (257)	1 (25)	1/2 (13)	1/4 (6)	0.4	6.7 (169)	1.23 (0.56)	83
SM-50-290N	Lever	24,000	1/4"	3/8 (10)	0.35 (257)	1 (25)	1/2 (13)	1/4 (6)	0.4	6.8 (173)	1.32 (0.6)	83
SM-50-291N	Lever	24,000	1/4"	3/8 (10)	0.35 (257)	1 (25)	1/2 (13)	1/4 (6)	0.4	6.8 (173)	1.32 (0.6)	83
SM-50-290S	Lever	24,000	1/4"	3/8 (10)	0.35 (257)	1 (25)	1/2 (13)	1/4 (6)	0.4	6.8 (173)	1.36 (0.62)	83
SM-50-291S	Lever	24,000	1/4"	3/8 (10)	0.35 (257)	1 (25)	1/2 (13)	1/4 (6)	0.4	6.8 (173)	1.36 (0.62)	83
SM-5E-260N	Lever	24,000	1/4"	3/8 (10)	0.35 (257)	1 (25)	1/2 (13)	1/4 (6)	0.4	11.8 (300)	2.2 (0.98)	83
SM-5E-261N	Lever	24,000	1/4"	3/8 (10)	0.35 (257)	1 (25)	1/2 (13)	1/4 (6)	0.4	11.8 (300)	2.2 (0.98)	83
SM-5E-260S	Lever	24,000	1/4"	3/8 (10)	0.35 (257)	1 (25)	1/2 (13)	1/4 (6)	0.4	11.8 (300)	2.2 (1)	83
SM-5E-261S	Lever	24,000	1/4"	3/8 (10))	0.35 (257)	1 (25)	1/2 (13)	1/4 (6)	0.4	11.8 (300)	2.2 (1)	83
SM-5E-260R	Ring	24,000	1/4"	3/8 (10))	0.35 (257)	1 (25)	1/2 (13)	1/4 (6)	0.4	11.7 (297)	1.98 (0.9)	83
SM-5E-261R	Ring	24,000	1/4"	3/8 (10)	0.35 (257)	1 (25)	1/2 (13)	1/4 (6)	0.4	11.7 (297)	1.98 (0.9)	83

* Recommended Air Pressure at 90 PSI (6.2 Bar)

Industrial Die Grinders



SM-5001

Heavy Duty Straight Die Grinder



Features:

- 12,000 RPM
- 0.5 HP
- Safety Lever
- Rear Exhaust

SM-53-5530

Industrial Die Grinder



Features:

- 32,000 RPM
- 0.5 HP
- Safety Lever
- Steel Motor Housing

SM-53-5522

Industrial Die Grinder



Features:

- 35,000 RPM
- 0.4 HP
- Rear Exhaust
- Low Vibration
- **Low Noise 75 dB(A)**

Specifications:

Model No.	Free Speed (RPM)	Collet Size Inch (mm)	Air Inlet (NPT)	Hose Size ID Inch (mm)	Air Consumption CFM (L/Min)	Hose Length Inch (mm)	Length Inch (mm)	Weight Lbs (Kg)	Power HP (Kw)
SM-5001	12,000	1/4 (6)	1/4"	3/8 (10)	4 (113)	-	12.5 (318)	2.9 (1.3)	0.5 (0.37)
SM-53-5530	32,000	1/4 (6)	1/4"	3/8 (10)	4 (113)	-	7.1 (180)	1.6 (0.73)	0.5 (0.37)
SM-53-5522	35,000	1/4 (6)	1/4"	3/8 (10)	4 (113)	29.5 (750)	7.9 (200)	1.3 (0.57)	0.4 (0.3)

* Recommended Air Pressure at 90 PSI (6.2 Bar)

Features:

- Built-in Comfort Grip
- Safety Throttle Lever
- **New Rotating Rear Regulator**
- Rear Exhaust with Silencer
- Rotating Air Inlet
- Low Noise **79 dB(A)**



▲ Operation of Mini Die Grinder



EH-522SUB

Exhaust Hose Assembly (Optional)

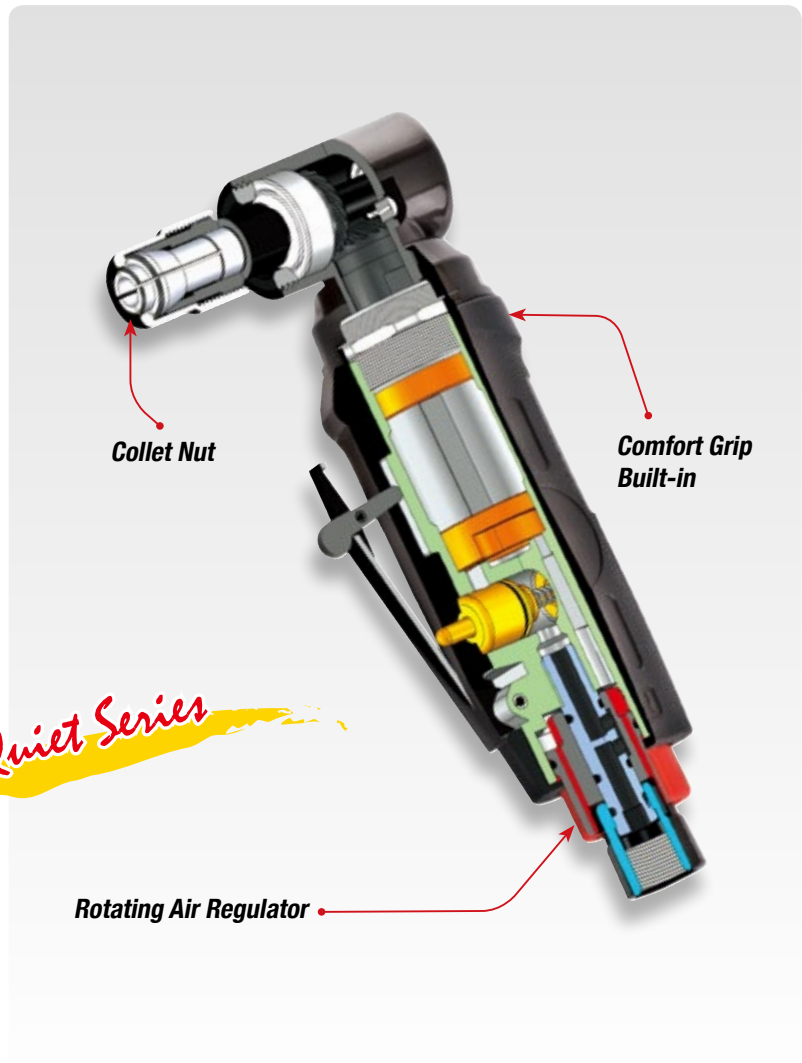

Patent No.

US 525 500S / US 7073774B2

EU 000 345723

TW D1190499 / M263196

Mini Die Grinders



SM-53-52251
1/4" Mini Die Grinder



SM-53-52252
1/4" Mini Die Grinder



SM-52-52251
1/4" 90° Angle Die Grinder



SM-52-52252
1/4" 90° Angle Die Grinder



SM-55-52251
1/4" 115° Angle Die Grinder



SM-55-52252
1/4" 115° Angle Die Grinder



SM-5E-52251
1/4" Extended Die Grinder



SM-5E-52252
1/4" Extended Die Grinder

Specifications:

Model No.	Free Speed (RPM)	Collet Size Inch (mm)	Air Inlet (NPT)	Hose Size ID Inch (mm)	Air Consumption CFM (L/Min)	Length Inch (mm)	Weight Lbs (Kg)	Noise Level dB(A)
SM-53-52251	25,000	1/4 (6) or 1/8 (3)	1/4"	3/8 (10)	4 (113)	6.4 (163)	0.9 (0.4)	79
SM-53-52252	25,000	1/4 (6) or 1/8 (3)	1/4"	3/8 (10)	4 (113)	6.4 (163)	0.9 (0.4)	79
SM-52-52251	20,000	1/4 (6) or 1/8 (3)	1/4"	3/8 (10)	4 (113)	6.5 (166)	1.1 (0.5)	79
SM-52-52252	20,000	1/4 (6) or 1/8 (3)	1/4"	3/8 (10)	4 (113)	6.5 (166)	1.1 (0.5)	79
SM-55-52251	20,000	1/4 (6) or 1/8 (3)	1/4"	3/8 (10)	4 (113)	7.9 (200)	1.1 (0.5)	79
SM-55-52252	20,000	1/4 (6) or 1/8 (3)	1/4"	3/8 (10)	4 (113)	7.9 (200)	1.1 (0.5)	79
SM-5E-52251	25,000	1/4 (6) or 1/8 (3)	1/4"	3/8 (10)	4 (113)	10.2 (258)	1.5 (0.7)	79
SM-5E-52252	25,000	1/4 (6) or 1/8 (3)	1/4"	3/8 (10)	4 (113)	10.2 (258)	1.5 (0.7)	79

* Recommended Air Pressure at 90 PSI (6.2 Bar)

Mini Die Grinder Kits

Features:

- Built-in Comfort Grip
- Safety Throttle Lever
- Air Regulator on Top
- Rear Exhaust with Silencer
- Rotating Air Inlet
- Low Noise **77 dB(A)**



▲ Operation of Mini Die Grinder



EH-522SUB

Exhaust Hose Assembly (Optional)

Quiet Series

SM-52-5227K

1/4" 90° Angle Die Grinder Kit

Kit Includes:

- 1 pc SM-52-5227 Angle Die Grinder
- 1 pc 1/8" (3mm) Collet
- 5 pcs 1/4" (6mm) Mounted Points
- 5 pcs 1/8" (3mm) Mounted Points



SM-53-5227K

1/4" Mini Die Grinder Kit

Kit Includes:

- 1 pc SM-53-5227 Die Grinder
- 1 pc 1/8" (3mm) Collet
- 5 pcs 1/4" (6mm) Mounted Points
- 5 pcs 1/8" (3mm) Mounted Points



Kit Includes:

- 1 pc SM-52-5227 Angle Die Grinder
- 1 pc 1/4" Collet (Installed)
- 1 pc 6mm Collet
- 2 pcs 52227-11SUB Spanner Wrench
- 1 pc 2" Backing Pad (1/4"-20 Thread)
- 2 pcs 2" Coarse Surface Prep Pads
- 2 pcs 2" Med Surface Prep Pads
- 2 pcs 2" Fine Surface Prep Pads
- 2 pcs 2" #24 Grit Sanding Discs
- 2 pcs 2" #36 Grit Sanding Discs
- 2 pcs 2" #50 Grit Sanding Discs
- 1 pc blow Molded Case

SM-52-5227K2

1/4" 90° Angle Die Grinder Kit



Patent No.

US 525 500S / US 7073774B2

EU 000 345723

TW D1190499 / M263196 / M316780

Mini Die Grinders

SM-53-5227
1/4" Mini Die Grinder



SM-53-5229
1/4" Mini Die Grinder



SM-52-5227
1/4" 90° Angle Die Grinder



SM-52-5229
1/4" 90° Angle Die Grinder



SM-55-5227
1/4" 115° Angle Die Grinder



SM-55-5229
1/4" 115° Angle Die Grinder



SM-5E-5227
1/4" Extended Die Grinder



SM-5E-5229
1/4" Extended Die Grinder



Specifications:

Model No.	Free Speed (RPM)	Collet Size Inch (mm)	Air Inlet (NPT)	Hose Size ID Inch (mm)	Air Consumption CFM (L/Min)	Length Inch (mm)	Weight Lbs (Kg)	Noise Level dB(A)
SM-53-5227	25,000	1/4 (6) or 1/8 (3)	1/4"	3/8 (10)	4 (113)	6.3 (159)	0.9 (0.4)	77
SM-53-5229	25,000	1/4 (6) or 1/8 (3)	1/4"	3/8 (10)	4 (113)	6.3 (159)	0.9 (0.4)	77
SM-52-5227	20,000	1/4 (6) or 1/8 (3)	1/4"	3/8 (10)	4 (113)	6.5 (165)	1.1 (0.5)	77
SM-52-5229	20,000	1/4 (6) or 1/8 (3)	1/4"	3/8 (10)	4 (113)	6.5 (165)	1.1 (0.5)	77
SM-55-5227	20,000	1/4 (6) or 1/8 (3)	1/4"	3/8 (10)	4 (113)	7.8 (197)	1.1 (0.5)	77
SM-55-5229	20,000	1/4 (6) or 1/8 (3)	1/4"	3/8 (10)	4 (113)	7.8 (197)	1.1 (0.5)	77
SM-5E-5227	25,000	1/4 (6) or 1/8 (3)	1/4"	3/8 (10)	4 (113)	10.1 (256)	1.5 (0.7)	77
SM-5E-5229	25,000	1/4 (6) or 1/8 (3)	1/4"	3/8 (10)	4 (113)	10.1 (256)	1.5 (0.7)	77

* Recommended Air Pressure at 90 PSI (6.2 Bar)

Family Looking Tools

Features:

- Built-in Comfort Grip
- Air Regulator on Top
- Safety Throttle Lever
- Rear Exhaust with Silencer
- Rotating Air Inlet
- **Low Noise 79 dB(A)**

Patent No.

US 525 500S / DE20 2006 016 578U1
EU 000 345723
TW D1190499 / M302447 / M308838 / M316780

SM-51-3011B

1/4" Die Grinder - Full Size



SM-51-3011BK
1/4" Die Grinder Kit

SM-54-3011B

1/4" Die Grinder



▲ Full-Cage Gear Design

SM-5F-3011B

1/4" Extended Die Grinder



SM-6K-3011B

Pinstripe Removal Tool



▲ Pad Size 3-1/2"

SM-29-3011B

Straight Air Shear



▲ Cutting Capacity Steel 1.2mm

SM-6F-3011B

Low Speed Tire Buffer



SM-5J-3011B

3" Cut-Off Tool



SM-76-3011B

3/8" Straight Air Drill



SM-7A-3011B

SM-7B-3011B

3/8" Straight Air Drill



▲ Full-Cage Gear Design

SM-7L-3011B

3/8" High Speed Straight Air Drill



Specifications:

Model No.	Free Speed (RPM)	Collet (or Chuck) Size Inch (mm)	Air Inlet (NPT)	Hose Size ID Inch (mm)	Air Consumption CFM (L/Min)	Length Inch (mm)	Weight Lbs (Kg)	Noise Level dB(A)
SM-51-3011B	20,000	1/4 (6)	1/4"	3/8 (10)	4 (113)	7.4 (188)	1.5 (0.7)	79
SM-54-3011B	4,000	1/4 (6)	1/4"	3/8 (10)	4 (113)	8.6 (218)	2.0 (0.9)	79
SM-5F-3011B	20,000	1/4 (6)	1/4"	3/8 (10)	4 (113)	13.7 (348)	2.9 (1.3)	79
SM-6K-3011B	4,000	-	1/4"	3/8 (10)	4 (113)	8.2 (209)	1.8 (0.8)	79
SM-6F-3011B	2,500	-	1/4"	3/8 (10)	4 (113)	10.0 (254)	2.4 (1.1)	79
SM-29-3011B	2,500	-	1/4"	3/8 (10)	4 (113)	10.4 (264)	2.4 (1.1)	79
SM-5J-3011B	20,000	-	1/4"	3/8 (10)	4 (113)	8 (203)	1.8 (0.8)	79
SM-76-3011B	2,500	3/8 (10)	1/4"	3/8 (10)	4 (113)	8.7 (222)	2.2 (1.0)	79
SM-7A-3011B	2,500	3/8 (10)	1/4"	3/8 (10)	4 (113)	9.3 (236)	2.2 (1.0)	79
SM-7B-3011B	4,000	3/8 (10)	1/4"	3/8 (10)	4 (113)	9.3 (236)	2.2 (1.0)	79
SM-7L-3011B	20,000	3/8 (10)	1/4"	3/8 (10)	4 (113)	9.3 (236)	1.5 (0.7)	79

* Recommended Air Pressure at 90 PSI (6.2 Bar)

Features:

- Built-in Comfort Grip
- Air Regulator on Top
- Safety Throttle Lever
- Rear Exhaust with Silencer
- Rotating Air Inlet
- **Low Noise 79 dB(A)**

SM-51-3011X

1/4" Die Grinder - Full Size

Patent No.

US 525 498S / US 525 499S / DE20 2006 016 578U1
EU 000 345707 / EU 000 345715
TW D115820 / M302447 / M308838 / M316780



SM-54-3011X

1/4" Die Grinder



▲ Full-Cage Gear Design

SM-5F-3011X

1/4" Extended Die Grinder



SM-6K-3011X

Pinstripe Removal Tool



▲ Pad Size 3-1/2"

SM-29-3011X

Straight Air Shear



▲ Cutting Capacity Steel 1.2mm

SM-6F-3011X

Low Speed Tire Buffer



SM-5J-3011X

3" Cut-Off Tool



SM-76-3011X

3/8" Straight Air Drill



SM-7A-3011X

SM-7B-3011X

3/8" Straight Air Drill



▲ Full-Cage Gear Design

SM-7L-3011X

3/8" High Speed Straight Air Drill



Specifications:

Model No.	Free Speed (RPM)	Collet (or Chuck) Size Inch (mm)	Air Inlet (NPT)	Hose Size ID Inch (mm)	Air Consumption CFM (L/Min)	Length Inch (mm)	Weight Lbs (Kg)	Noise Level dB(A)
SM-51-3011X	20,000	1/4 (6)	1/4"	3/8 (10)	4 (113)	7.4 (188)	1.5 (0.7)	79
SM-54-3011X	4,000	1/4 (6)	1/4"	3/8 (10)	4 (113)	8.6 (218)	2.0 (0.9)	79
SM-5F-3011X	20,000	1/4 (6)	1/4"	3/8 (10)	4 (113)	13.7 (348)	2.9 (1.3)	79
SM-6K-3011X	4,000	-	1/4"	3/8 (10)	4 (113)	8.2 (209)	1.8 (0.8)	79
SM-6F-3011X	2,500	-	1/4"	3/8 (10)	4 (113)	10 (254)	2.4 (1.1)	79
SM-29-3011X	2,500	-	1/4"	3/8 (10)	4 (113)	10.4 (264)	2.4 (1.1)	79
SM-5J-3011X	20,000	-	1/4"	3/8 (10)	4 (113)	8 (203)	1.8 (0.8)	79
SM-76-3011X	2,500	3/8 (10)	1/4"	3/8 (10)	4 (113)	8.7 (222)	2.2 (1.0)	79
SM-7A-3011X	2,500	3/8 (10)	1/4"	3/8 (10)	4 (113)	9.3 (236)	2.2 (1.0)	79
SM-7B-3011X	4,000	3/8 (10)	1/4"	3/8 (10)	4 (113)	9.3 (236)	2.2 (1.0)	79
SM-7L-3011X	20,000	3/8 (10)	1/4"	3/8 (10)	4 (113)	9.3 (236)	1.5 (0.7)	79

* Recommended Air Pressure at 90 PSI (6.2 Bar)

Features:

- Built-in Comfort Grip
- Safety Throttle Lever
- Rotating Rear Regulator
- Rotating Air Inlet
- **Low Noise 79 dB(A)**

SM-51-3011Y

1/4" Die Grinder - Full Size



Patent No.

US 525 500S / US 7073774B2 / EU 000 345723
TW D1190499 / M263196

SM-54-3011Y

1/4" Die Grinder



▲ Full-Cage Gear Design

SM-5F-3011Y

1/4" Extended Die Grinder



SM-6K-3011Y

Pinstripe Removal Tool



▲ Pad Size 3-1/2"

SM-29-3011Y

Straight Air Shear



▲ Cutting Capacity Steel 1.2mm

SM-6F-3011Y

Low Speed Tire Buffer



SM-5J-3011Y

3" Cut-Off Tool



SM-76-3011Y

3/8" Straight Air Drill



SM-7A-3011Y

SM-7B-3011Y

3/8" Straight Air Drill



▲ Full-Cage Gear Design

SM-7L-3011Y

3/8" High Speed Straight Air Drill



Specifications:

Model No.	Free Speed (RPM)	Collet (or Chuck) Size Inch (mm)	Air Inlet (NPT)	Hose Size ID Inch (mm)	Air Consumption CFM (L/Min)	Length Inch (mm)	Weight Lbs (Kg)	Noise Level dB(A)
SM-51-3011Y	20,000	1/4 (6)	1/4"	3/8 (10)	4 (113)	7.4 (188)	1.5 (0.7)	79
SM-54-3011Y	4,000	1/4 (6)	1/4"	3/8 (10)	4 (113)	8.6 (218)	2.0 (0.9)	79
SM-5F-3011Y	20,000	1/4 (6)	1/4"	3/8 (10)	4 (113)	13.7 (348)	2.9 (1.3)	79
SM-6K-3011Y	4,000	-	1/4"	3/8 (10)	4 (113)	8.9 (226)	1.8 (0.8)	79
SM-6F-3011Y	2,500	-	1/4"	3/8 (10)	4 (113)	10 (254)	2.4 (1.1)	79
SM-29-3011Y	2,500	-	1/4"	3/8 (10)	4 (113)	10.4 (264)	2.4 (1.1)	79
SM-5J-3011Y	20,000	-	1/4"	3/8 (10)	4 (113)	8 (203)	1.8 (0.8)	79
SM-76-3011Y	2,500	3/8 (10)	1/4"	3/8 (10)	4 (113)	9.5 (241)	2.2 (1.0)	79
SM-7A-3011Y	2,500	3/8 (10)	1/4"	3/8 (10)	4 (113)	9.3 (236)	2.2 (1.0)	79
SM-7B-3011Y	4,000	3/8 (10)	1/4"	3/8 (10)	4 (113)	9.3 (236)	2.2 (1.0)	79
SM-7L-3011Y	20,000	3/8 (10)	1/4"	3/8 (10)	4 (113)	9.3 (236)	1.5 (0.7)	79

* Recommended Air Pressure at 90 PSI (6.2 Bar)

Family Looking Tools

Features:

- Built-in Comfort Grip
- Safety Throttle Lever
- Rotating Rear Regulator
- Rotating Air Inlet
- **Low Noise 79 dB(A)**

SM-51-3011Z

1/4" Die Grinder - Full Size



Patent No.

US 525 498S / US 7073774B2 / EU 000 345715
TW D115820 / M263196

SM-54-3011Z

1/4" Die Grinder



▲ Full-Cage Gear Design

SM-5F-3011Z

1/4" Extended Die Grinder



SM-6K-3011Z

Pinstripe Removal Tool



▲ Pad Size 3-1/2"

SM-29-3011Z

Straight Air Shear



▲ Cutting Capacity Steel 1.2mm

SM-6F-3011Z

Low Speed Tire Buffer



SM-5J-3011Z

3" Cut-Off Tool



SM-76-3011Z

3/8" Straight Air Drill



SM-7A-3011Z

SM-7B-3011Z

3/8" Straight Air Drill



▲ Full-Cage Gear Design

SM-7L-3011Z

3/8" High Speed Straight Air Drill



Specifications:

Model No.	Free Speed (RPM)	Collet (or Chuck) Size Inch (mm)	Air Inlet (NPT)	Hose Size ID Inch (mm)	Air Consumption CFM (L/Min)	Length Inch (mm)	Weight Lbs (Kg)	Noise Level dB(A)
SM-51-3011Z	20,000	1/4 (6)	1/4"	3/8 (10)	4 (113)	7.4 (188)	1.5 (0.7)	79
SM-54-3011Z	4,000	1/4 (6)	1/4"	3/8 (10)	4 (113)	8.6 (218)	2.0 (0.9)	79
SM-5F-3011Z	20,000	1/4 (6)	1/4"	3/8 (10)	4 (113)	13.7 (348)	2.9 (1.3)	79
SM-6K-3011Z	4,000	-	1/4"	3/8 (10)	4 (113)	8.9 (226)	1.8 (0.8)	79
SM-6F-3011Z	2,500	-	1/4"	3/8 (10)	4 (113)	10 (254)	2.4 (1.1)	79
SM-29-3011Z	2,500	-	1/4"	3/8 (10)	4 (113)	10.4 (264)	2.4 (1.1)	79
SM-5J-3011Z	20,000	-	1/4"	3/8 (10)	4 (113)	8 (203)	1.8 (0.8)	79
SM-76-3011Z	2,500	3/8 (10)	1/4"	3/8 (10)	4 (113)	9.5 (241)	2.2 (1.0)	79
SM-7A-3011Z	2,500	3/8 (10)	1/4"	3/8 (10)	4 (113)	9.3 (236)	2.2 (1.0)	79
SM-7B-3011Z	4,000	3/8 (10)	1/4"	3/8 (10)	4 (113)	9.3 (236)	2.2 (1.0)	79
SM-7L-3011Z	20,000	3/8 (10)	1/4"	3/8 (10)	4 (113)	9.3 (236)	1.5 (0.7)	79

* Recommended Air Pressure at 90 PSI (6.2 Bar)

Family Looking Tools

Features:

- **Composite Motor Housing**
- Full-Size Square Handle
- Safety Throttle Lever
- Rear Exhaust
- **Low Noise 83 dB(A)**
- **0.5 HP**

SM-572P

1/4" Air Die Grinder



SM-575P

1/4" Air Die Grinder



▲ Full-Cage Gear Design



EH-512SUB

Exhaust Hose Assembly (Optional)



▲ Operation of Die Grinder

SM-572FP

1/4" Extended Die Grinder



SM-671P

Low Speed Tire Buffer



SM-576P

3" Cut-Off Tool



Specifications:

Model No.	Free Speed (RPM)	Collet Size Inch (mm)	Air Inlet (NPT)	Hose Size ID Inch (mm)	Air Consumption CFM (L/Min)	Length Inch (mm)	Weight Lbs (Kg)	Noise Level dB(A)
SM-572P	23,000	1/4 (6) or 1/8 (3)	1/4"	3/8 (10)	4 (113)	6.7 (170)	1.2 (0.5)	83
SM-575P	4,500	1/4 (6) or 1/8 (3)	1/4"	3/8 (10)	4 (113)	8.3 (210)	1.3 (0.6)	83
SM-572FP	23,000	1/4 (6) or 1/8 (3)	1/4"	3/8 (10)	4 (113)	13 (330)	2.6 (1.2)	83
SM-671P	2,600	-	1/4"	3/8 (10)	4 (113)	9.3 (237)	1.9 (0.9)	83
SM-576P	22,000	3 (75)	1/4"	3/8 (10)	4 (113)	7.4 (188)	1.5 (0.7)	83

* Recommended Air Pressure at 90 PSI (6.2 Bar)

Die Grinders - Industrial

Features:

- **1.0 HP Motor**
- Safety Throttle Lever
- Rear Exhaust
- Erickson Collet
(Only for SM-50-5200,
SM-5E-5200 & SM-52-5201)



▲ Industry Standard Erickson Collet

- #50-500228-11 (1/4")
- #50-500228-13 (3mm)
- #50-500228-16 (6mm)
- #50-500228-18 (8mm)

1.0 HP



SM-50-5200
Die Grinder



SM-5E-5200
Extended Die Grinder



SM-52-5201
Angle Die Grinder



SM-52-5200
Angle Die Grinder

Specifications :

Model No.	Free Speed (RPM)	Collet Size Inch (mm)	Air Inlet (NPT)	Hose Size ID Inch (mm)	Air Consumption CFM (L/Min)	Length Inch (mm)	Weight Lbs (Kg)	Power HP (Kw)
SM-50-5200-14	20,000	1/4	1/4"	3/8 (10)	5.3 (150)	7.9 (200)	1.8 (0.8)	1.0 (0.7)
SM-50-5200-6	20,000	6 mm	1/4"	3/8 (10)	5.3 (150)	7.9 (200)	1.8 (0.8)	1.0 (0.7)
SM-50-5200-8	20,000	8 mm	1/4"	3/8 (10)	5.3 (150)	7.9 (200)	1.8 (0.8)	1.0 (0.7)
SM-5E-5200-14	20,000	1/4	1/4"	3/8 (10)	5.3 (150)	13 (330)	2.6 (1.2)	1.0 (0.7)
SM-5E-5200-6	20,000	6 mm	1/4"	3/8 (10)	5.3 (150)	13 (330)	2.6 (1.2)	1.0 (0.7)
SM-5E-5200-8	20,000	8 mm	1/4"	3/8 (10)	5.3 (150)	13 (330)	2.6 (1.2)	1.0 (0.7)
SM-52-5201-14	12,000	1/4	1/4"	3/8 (10)	5.3 (150)	8.3 (212)	2.6 (1.2)	1.0 (0.7)
SM-52-5201-6	12,000	6 mm	1/4"	3/8 (10)	5.3 (150)	8.3 (212)	2.6 (1.2)	1.0 (0.7)
SM-52-5201-8	12,000	8 mm	1/4"	3/8 (10)	5.3 (150)	8.3 (212)	2.6 (1.2)	1.0 (0.7)
SM-52-5200-14	12,000	1/4	1/4"	3/8 (10)	5.3 (150)	8.3 (212)	2.6 (1.2)	1.0 (0.7)
SM-52-5200-6	12,000	6 mm	1/4"	3/8 (10)	5.3 (150)	8.3 (212)	2.6 (1.2)	1.0 (0.7)

* Recommended Air Pressure at 90 PSI (6.2 Bar)

0.4 HP & 0.7 HP Die Grinders

Features:

- **0.4 HP & 0.7 HP Motor**
- Safety Throttle Lever
- Rear Exhaust
- Erickson Collet

SM-5125A

1/4" Die Grinder
- 25,000 RPM



SM-5130A

1/4" Die Grinder
- 30,000 RPM

0.4 HP

SM-5225B

1/4" Die Grinder
- 25,000 RPM



SM-5230B

1/4" Die Grinder
- 30,000 RPM

SM-5115C

1/4" Die Grinder
- 15,000 RPM

SM-5118C

1/4" Die Grinder
- 18,000 RPM

SM-5120C

1/4" Die Grinder
- 20,000 RPM



0.7 HP

SM-5218D

1/4" Die Grinder
- 18,000 RPM

SM-5220D

1/4" Die Grinder
- 20,000 RPM



Specifications:

Model No.	Free Speed (RPM)	Collet Size Inch (mm)	Air Inlet (NPT)	Hose Size ID Inch (mm)	Air Consumption CFM (L/Min) Free Speed	Length Inch (mm)	Weight Lbs (Kg)	Power Watt (HP)
SM-5125A	25,000	1/4 (6)	1/4"	1/4 (6)	23 (651)	6.7 (170)	0.9 (0.4)	298 (0.4)
SM-5130A	30,000	1/4 (6)	1/4"	1/4 (6)	23 (651)	6.7 (170)	0.9 (0.4)	298 (0.4)
SM-5225B	25,000	1/4 (6)	1/4"	1/4 (6)	23 (651)	7.3 (185)	1.1 (0.5)	298 (0.4)
SM-5230B	30,000	1/4 (6)	1/4"	1/4 (6)	23 (651)	7.3 (185)	1.1 (0.5)	298 (0.4)
SM-5115C	15,000	1/4 (6)	1/4"	3/8 (10)	31 (878)	8.3 (210)	1.8 (0.8)	522 (0.7)
SM-5118C	18,000	1/4 (6)	1/4"	3/8 (10)	33 (935)	8.3 (210)	1.8 (0.8)	522 (0.7)
SM-5120C	20,000	1/4 (6)	1/4"	3/8 (10)	34 (963)	8.3 (210)	1.8 (0.8)	522 (0.7)
SM-5218D	18,000	1/4 (6)	1/4"	3/8 (10)	34 (963)	7.6 (193)	2.2 (1.0)	522 (0.7)
SM-5220D	20,000	1/4 (6)	1/4"	3/8 (10)	37 (1,048)	7.6 (193)	2.2 (1.0)	522 (0.7)

* Recommended Air Pressure at 90 PSI (6.2 Bar)

Angle Die Grinders

Features:

- **0.5 HP** Motor
- Safety Throttle Lever
- Rear Exhaust



SM-52-301B

1/4" 90° Angle Die Grinder
- Built-in Comfort Grip



SM-52-512B

1/4" 90° Angle Die Grinder



SM-52-301X

1/4" 90° Angle Die Grinder
- Built-in Comfort Grip

Specifications:

Model No.	Free Speed (RPM)	Collet Size Inch (mm)	Air Inlet (NPT)	Hose Size ID Inch (mm)	Air Consumption CFM (L/Min)	Length Inch (mm)	Weight Lbs (Kg)	Power HP (Kw)
SM-52-301B	20,000	1/4 (6)	1/4"	3/8 (10)	3.3 (93)	7.2 (183)	1.8 (0.8)	0.5 (0.37)
SM-52-512B	23,000	1/4 (6)	1/4"	3/8 (10)	4 (113)	7.3 (186)	1.8 (0.8)	0.5 (0.37)
SM-52-301X	20,000	1/4 (6)	1/4"	3/8 (10)	3.3 (93)	7.2 (183)	1.8 (0.8)	0.5 (0.37)

* Recommended Air Pressure at 90 PSI (6.2 Bar)



Features:

- Stainless Steel **Governor for Reliability and Maintaining Speed under Load**
- **Safety Lever**
- **Side Exhaust**
- **3.0 HP or 4.0 HP** Motor for Extra Stall Resistance
- **Simple Design with One-piece Housing**
- **Best for: Extra Heavy Duty Continuous Material Removal and Grinding**

SM-5F-300C

6" Vertical Grinder
- 3.0 HP



SM-5F-400C

6" Vertical Grinder
- 4.0 HP



SM-5G-300V

7" Vertical Grinder
- 3.0 HP



SM-5G-400V

7" Vertical Grinder
- 4.0 HP



SM-5H-300V

9" Vertical Grinder
- 3.0 HP



SM-5H-400V

9" Vertical Grinder
- 4.0 HP



Specifications:

Model No.	Free Speed (RPM)	Power Watt (HP)	Grinding Wheel Size Inch (mm)	Guard Type	Spindle Thread	Air Inlet (NPT)	Hose Size ID Inch (mm)	Air Consumption CFM (L/Min)	Length Inch (mm)	Height Inch (mm)	Weight Lbs (Kg)
SM-5F-300C	6,000	2,238 (3)	6 (150) Cup	Type11	5/8"-11	1/2"	1/2 (13)	12 (340)	12.8 (325)	7.9 (201)	10.4 (4.7)
SM-5F-400C	6,000	2,984 (4)	6 (150) Cup	Type11	5/8"-11	1/2"	1/2 (13)	16 (453)	12.9 (328)	8.8 (223)	12.1 (5.5)
SM-5G-300V	6,000	2,238 (3)	7 (180) Type27	Type27	5/8"-11	1/2"	1/2 (13)	12 (340)	11.8 (300)	7.8 (197)	9.7 (4.4)
SM-5G-400V	6,000	2,984 (4)	7 (180) Type27	Type27	5/8"-11	1/2"	1/2 (13)	16 (453)	12 (304)	8.6 (219)	11.5 (5.2)
SM-5H-300V	6,000	2,238 (3)	9 (225) Type27	Type27	5/8"-11	1/2"	1/2 (13)	12 (340)	13.1 (333)	7.6 (193)	10.4 (4.7)
SM-5H-400V	6,000	2,984 (4)	9 (225) Type27	Type27	5/8"-11	1/2"	1/2 (13)	16 (453)	13.3 (337)	8.5 (215)	12.1 (5.5)

* Recommended Air Pressure at 90 PSI (6.2 Bar)

Features:

- Stainless Steel **Governor for Reliability and Maintaining Speed under Load**
- **Safety Lever**
- **Side Exhaust**
- **3.0 HP or 4.0 HP** Motor for Extra Stall Resistance
- **Best for: Extra Heavy Duty Continuous Material Removal and Grinding**



Silencer

▲ with Silencer to Reduce Noise (Optional)

#5G-321V20 (Silencer for 3.0 HP)
#5H-421V20 (Silencer for 4.0 HP)

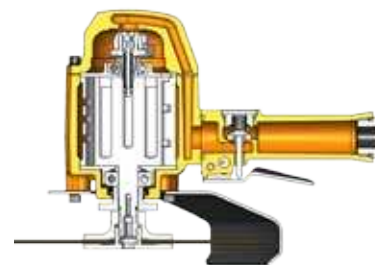

▲ Additional Flanges for Type 41 Flat Wheel (Optional)

#5H-421V28 (Flange)
#5H-421V29 (Flange Nut)

SM-5F-321C

6" Vertical Grinder
- 3.0 HP



SM-5G-321V

7" Vertical Grinder
- 3.0 HP



SM-5H-321V

9" Vertical Grinder
- 3.0 HP



SM-5F-421C

6" Vertical Grinder
- 4.0 HP



SM-5G-421V

7" Vertical Grinder
- 4.0 HP



SM-5H-421V

9" Vertical Grinder
- 4.0 HP



Specifications:

Model No.	Free Speed (RPM)	Power Watt (HP)	Grinding Wheel Size Inch (mm)	Guard Type	Spindle Thread	Air Inlet (NPT)	Hose Size ID Inch (mm)	Air Consumption CFM (L/Min) Free Speed	Air Consumption CFM (L/Min) @Loading	Length Inch (mm)	Height Inch (mm)	Weight Lbs (Kg)
SM-5F-321C	6,000	2,238 (3)	6 (150) Cup	Type 11	5/8"-11	1/2"	1/2 (13)	21.6 (611)	52.7 (1,490)	12.5 (317)	8 (202)	10.4 (4.7)
SM-5G-321V	6,000	2,238 (3)	7 (180) Type 27	Type 27	5/8"-11	1/2"	1/2 (13)	21.6 (611)	52.7 (1,490)	11.5 (291)	7.8 (198)	9.7 (4.4)
SM-5H-321V	6,000	2,238 (3)	9 (225) Type 27	Type 27	5/8"-11	1/2"	1/2 (13)	21.6 (611)	52.7 (1,490)	12.9 (327)	7.8 (199)	10.4 (4.7)
SM-5F-421C	6,000	2,984 (4)	6 (150) Cup	Type 11	5/8"-11	1/2"	1/2 (13)	33.9 (960)	72.5 (2,051)	12.5 (318)	8.7 (222)	12.3 (5.6)
SM-5G-421V	6,000	2,984 (4)	7 (180) Type 27	Type 27	5/8"-11	1/2"	1/2 (13)	33.9 (960)	72.5 (2,051)	11.6 (295)	8.6 (218)	11.7 (5.3)
SM-5H-421V	6,000	2,984 (4)	9 (225) Type 27	Type 27	5/8"-11	1/2"	1/2 (13)	33.9 (960)	72.5 (2,051)	13.1 (332)	8.6 (219)	12.3 (5.6)

* Recommended Air Pressure at 90 PSI (6.2 Bar)

Angle Grinder

SM-5D-6191PS

5" Angle Grinder

Features:

- **with Speed Governor**
- **Composite** Motor Housing
- **Rear Exhaust (Silencer)**
- **Safety Throttle Lever**
- **Spindle Lock** Allows Quick and Easy Disc Change
- **9 Position Adjustable Swivel Guard**
- **1.4 HP Motor**



EH-6191SUB

Exhaust Hose Assembly (Optional)



Specifications:

Model No.	Free Speed (RPM)	Power HP (Kw)	Grinding Wheel Size Inch (mm)	Spindle Thread	Air Inlet (NPT)	Hose Size ID Inch (mm)	Air Consumption CFM (L/Min) Free Speed	Air Consumption CFM (L/Min) @Load	Length Inch (mm)	Weight Lbs (Kg)
SM-5B-6191PS/38	12,000	1.4 (1.04)	4 (100)	3/8"-24	3/8"	1/2 (13)	27.2 (770)	36.9 (1,044)	10 (253)	4.2 (1.9)
SM-5B-6191PS/M10	12,000	1.4 (1.04)	4 (100)	M10x1.5	3/8"	1/2 (13)	27.2 (770)	36.9 (1,044)	10 (253)	4.2 (1.9)
SM-5C-6191PS/58	12,000	1.4 (1.04)	4-1/2 (115)	5/8"-11	3/8"	1/2 (13)	27.2 (770)	36.9 (1,044)	10 (253)	4.4 (2.0)
SM-5C-6191PS/M14	12,000	1.4 (1.04)	4-1/2 (115)	M14x2.0	3/8"	1/2 (13)	27.2 (770)	36.9 (1,044)	10 (253)	4.4 (2.0)
SM-5C-6191PS/38	12,000	1.4 (1.04)	4-1/2 (115)	3/8"-24	3/8"	1/2 (13)	27.2 (770)	36.9 (1,044)	10 (253)	4.4 (2.0)
SM-5D-6191PS/58	12,000	1.4 (1.04)	5 (125)	5/8"-11	3/8"	1/2 (13)	27.2 (770)	36.9 (1,044)	10 (253)	4.4 (2.0)
SM-5D-6191PS/M14	12,000	1.4 (1.04)	5 (125)	M14x2.0	3/8"	1/2 (13)	27.2 (770)	36.9 (1,044)	10 (253)	4.4 (2.0)
SM-5D-6191PS/38	12,000	1.4 (1.04)	5 (125)	3/8"-24	3/8"	1/2 (13)	27.2 (770)	36.9 (1,044)	10 (253)	4.4 (2.0)

* Recommended Air Pressure at 90 PSI (6.2 Bar)

Angle Grinders

Features:

- With Speed Governor
- Spindle Lock Design
- Lightweight, Compact Size
- 1.2 HP / 1.8 HP Motor
- Lower Angle Head
- Life Time 1,000 Hours

SM-5B-6400L

4" Angle Grinder

- Lever Type
- 1.2 HP



SM-5D-6400L

5" Angle Grinder

- Lever Type
- 1.2 HP



SM-5G-6700L

7" Angle Grinder

- Lever Type
- 1.8 HP



SM-5B-6400R

4" Angle Grinder

- Roll Type
- 1.2 HP



SM-5D-6400R

5" Angle Grinder

- Roll Type
- 1.2 HP



SM-5G-6700R

7" Angle Grinder

- Roll Type
- 1.8 HP



Specifications:

Model No.	Free Speed (RPM)	Power Watt (HP)	Capacity Wheel Inch (mm)	Wheel Hole Size Inch (mm)	Air Inlet (NPT)	Hose Size ID Inch (mm)	Air Consumption CFM (L/Min) Free Speed	Air Consumption CFM (L/Min) @Load	Length Inch (mm)	Weight Lbs (Kg)	Remark
SM-5B-6400L/15	13,000	895 (1.2)	4 (100)	15 mm	3/8"	1/2 (13)	27 (764)	33 (934)	8.8 (223)	2.98 (1.35)	for Japan
SM-5B-6400L/16	13,000	895 (1.2)	4 (100)	5/8 (16)	3/8"	1/2 (13)	27 (764)	33 (934)	8.8 (223)	2.98 (1.35)	-
SM-5B-6400R/15	13,000	895 (1.2)	4 (100)	15 mm	1/4"	3/8 (10)	27 (764)	33 (934)	8.3 (210)	3.2 (1.45)	for Japan
SM-5B-6400R/16	13,000	895 (1.2)	4 (100)	5/8 (16)	1/4"	3/8 (10)	27 (764)	33 (934)	8.3 (210)	3.2 (1.45)	-
SM-5D-6400L	12,000	895 (1.2)	5 (125)	7/8 (22)	3/8"	1/2 (13)	27 (764)	33 (934)	8.8 (223)	3.17 (1.44)	-
SM-5D-6400R	12,000	895 (1.2)	5 (125)	7/8 (22)	1/4"	3/8 (10)	27 (764)	33 (934)	8.3 (210)	3.4 (1.54)	-
SM-5G-6700L	7,600	1,342 (1.8)	7 (180)	7/8 (22)	3/8"	1/2 (13)	32 (906)	44 (1,245)	11 (280)	5.95 (2.7)	-
SM-5G-6700R	7,600	1,342 (1.8)	7 (180)	7/8 (22)	3/8"	1/2 (13)	32 (906)	44 (1,245)	9.4 (240)	5.51 (2.5)	-

* Recommended Air Pressure at 90 PSI (6.2 Bar)

Angle Grinders

Features:

- **With Speed Governor**
- **9 Position Adjustable Swivel Guard**
(for SM-5B-6414S, SM-5C-6414S, SM-5D-6414S)
- **Rear Exhaust**
- **1.1 HP Motor**
- **Lightweight 3.5 Lbs (1.6 Kgs)**



SM-5B-6414
4" Angle Grinder

SM-5C-6414
4-1/2" Angle Grinder

SM-5D-6414
5" Angle Grinder

► Swivel Guard Adjustable in 9 Positions

SM-5B-6414S
4" Angle Grinder

SM-5C-6414S
4-1/2" Angle Grinder

SM-5D-6414S
5" Angle Grinder



Specifications:

Model No.	Free Speed (RPM)	Power Watt (HP)	Grinding Wheel Size Inch (mm)	Spindle Thread	Air Inlet (NPT)	Hose Size ID Inch (mm)	Air Consumption CFM (L/Min) @Load	Length Inch (mm)	Weight Lbs (Kg)
SM-5B-6414/38	12,000	820 (1.1)	4 (100)	3/8"-24	1/4"	3/8 (10)	20 (558)	9.7 (247)	3.5 (1.6)
SM-5B-6414/M10	12,000	820 (1.1)	4 (100)	M10x1.5	1/4"	3/8 (10)	20 (558)	9.7 (247)	3.5 (1.6)
SM-5C-6414/38	12,000	820 (1.1)	4-1/2 (115)	3/8"-24	1/4"	3/8 (10)	20 (558)	9.7 (247)	3.5 (1.6)
SM-5C-6414/M14	12,000	820 (1.1)	4-1/2 (115)	M14x2.0	1/4"	3/8 (10)	20 (558)	9.7 (247)	3.5 (1.6)
SM-5C-6414/58	12,000	820 (1.1)	4-1/2 (115)	5/8"-11	1/4"	3/8 (10)	20 (558)	9.7 (247)	3.5 (1.6)
SM-5D-6414/38	12,000	820 (1.1)	5 (125)	3/8"-24	1/4"	3/8 (10)	20 (558)	9.7 (247)	3.5 (1.6)
SM-5D-6414/M14	12,000	820 (1.1)	5 (125)	M14x2.0	1/4"	3/8 (10)	20 (558)	9.7 (247)	3.5 (1.6)
SM-5D-6414/58	12,000	820 (1.1)	5 (125)	5/8"-11	1/4"	3/8 (10)	20 (558)	9.7 (247)	3.5 (1.6)
SM-5B-6414S/38	12,000	820 (1.1)	4 (100)	3/8"-24	1/4"	3/8 (10)	20 (558)	10 (253)	3.5 (1.6)
SM-5B-6414S/M10	12,000	820 (1.1)	4 (100)	M10x1.5	1/4"	3/8 (10)	20 (558)	10 (253)	3.5 (1.6)
SM-5C-6414S/38	12,000	820 (1.1)	4-1/2 (115)	3/8"-24	1/4"	3/8 (10)	20 (558)	10 (253)	3.5 (1.6)
SM-5C-6414S/M14	12,000	820 (1.1)	4-1/2 (115)	M14x2.0	1/4"	3/8 (10)	20 (558)	10 (253)	3.5 (1.6)
SM-5C-6414S/58	12,000	820 (1.1)	4-1/2 (115)	5/8"-11	1/4"	3/8 (10)	20 (558)	10 (253)	3.5 (1.6)
SM-5D-6414S/38	12,000	820 (1.1)	5 (125)	3/8"-24	1/4"	3/8 (10)	20 (558)	10 (253)	3.5 (1.6)
SM-5D-6414S/M14	12,000	820 (1.1)	5 (125)	M14x2.0	1/4"	3/8 (10)	20 (558)	10 (253)	3.5 (1.6)
SM-5D-6414S/58	12,000	820 (1.1)	5 (125)	5/8"-11	1/4"	3/8 (10)	20 (558)	10 (253)	3.5 (1.6)

* Recommended Air Pressure at 90 PSI (6.2 Bar)

Angle Grinders -

Heavy Industrial



SM-5B-6422

4" Angle Grinder
- 12,000 RPM
- 1.6 HP

SM-5C-6422

4-1/2" Angle Grinder
- 12,000 RPM
- 1.6 HP

SM-5D-6422

5" Angle Grinder
- 12,000 RPM
- 1.6 HP



SM-5G-6423

7" Angle Grinder
- 8,400 RPM
- 2.2HP

Features:

- With Speed Governor
- Lever Type
- Side Exhaust
- Side Handle

Specifications:

Model No.	Free Speed (RPM)	Power Watt (HP)	Abrasive Capacity	Spindle Thread	Air Inlet (NPT)	Hose Size ID Inch (mm)	Air Consumption CFM (L/Min) Free Speed	Air Consumption CFM (L/Min) @Load	Length Inch (mm)	Weight Lbs (Kg)
SM-5B-6422/38	12,000	1,193 (1.6)	4"	3/8"-24	3/8"	3/8 (10)	33 (934)	41 (1,160)	10.9 (278)	4 (1.8)
SM-5C-6422/58	12,000	1,193 (1.6)	4-1/2"	5/8"-11	3/8"	3/8 (10)	33 (934)	41 (1,160)	10.9 (278)	4.2 (1.9)
SM-5D-6422/58	12,000	1,193 (1.6)	5"	5/8"-11	3/8"	3/8 (10)	33 (934)	41 (1,160)	10.9 (278)	4.2 (1.9)
SM-5D-6422/M14	12,000	1,193 (1.6)	5"	M14x2.0	3/8"	3/8 (10)	33 (934)	41 (1,160)	10.9 (278)	4.2 (1.9)
SM-5G-6423/58	8,400	1,641 (2.2)	7"	5/8"-11	3/8"	1/2 (13)	37 (1,047)	56 (1,585)	12.7 (323)	7.5 (3.4)
SM-5G-6423/M14	8,400	1,641 (2.2)	7"	M14x2.0	3/8"	1/2 (13)	37 (1,047)	56 (1,585)	12.7 (323)	7.5 (3.4)

* Recommended Air Pressure at 90 PSI (6.2 Bar)

Features:

- With Speed Governor
- Side Exhaust
- Side Handle

SM-5D-6412

- 5" Angle Grinder
 - Lever Type
 - 12,000 RPM
 - 1.6 HP



SM-5D-6412R

- 5" Angle Grinder
 - Roll Type
 - 12,000 RPM
 - 1.6 HP



SM-5G-6413

- 7" Angle Grinder
 - Lever Type
 - 8,400 RPM
 - 2.2 HP



SM-5G-6413R

- 7" Angle Grinder
 - Roll Type
 - 8,400 RPM
 - 2.2 HP



Specifications:

Model No.	Free Speed (RPM)	Power Watt (HP)	Capacity Wheel Inch (mm)	Air Inlet (NPT)	Hose Size ID Inch (mm)	Air Consumption CFM (L/Min) Free Speed	Air Consumption CFM (L/Min) @Load	Length Inch (mm)	Weight Lbs (Kg)
SM-5D-6412	12,000	1,193 (1.6)	5 x 1/4 x 7/8 (125 x 6 x 22.2)	3/8"	3/8 (10)	33 (934)	41 (1,160)	11.7 (296)	4.6 (2.1)
SM-5D-6412R	12,000	1,193 (1.6)	5 x 1/4 x 7/8 (125 x 6 x 22.2)	3/8"	3/8 (10)	33 (934)	41 (1,160)	9.1 (232)	4.4 (2)
SM-5G-6413	8,400	1,641 (2.2)	7 x 1/4 x 7/8 (180 x 6 x 22.2)	3/8"	1/2 (13)	37 (1,047)	56 (1,585)	12.7 (323)	6.6 (3)
SM-5G-6413R	8,400	1,641 (2.2)	7 x 1/4 x 7/8 (180 x 6 x 22.2)	3/8"	1/2 (13)	37 (1,047)	56 (1,585)	10.9 (277)	6.6 (3)

* Recommended Air Pressure at 90 PSI (6.2 Bar)

Angle Grinders - Heavy Industrial

SM-5B-6410

4" Angle Grinder
- Lever Type

SM-5C-6410

4-1/2" Angle Grinder
- Lever Type

SM-5D-6410

5" Angle Grinder
- Lever Type



Features:

- With Speed Governor
- Accept 0.8 mm~6 mm Disc
- Built-in Comfort Grip
- Rear Exhaust
- **1.1 HP Motor**

SM-5B-6410R

4" Angle Grinder
- Roll Type

SM-5C-6410R

4-1/2" Angle Grinder
- Roll Type

SM-5D-6410R

5" Angle Grinder
- Roll Type



Specifications:

Model No.	Free Speed (RPM)	Power Watt (HP)	Capacity Wheel Inch (mm)	Spindle Thread	Air Inlet (NPT)	Hose Size ID Inch (mm)	Air Consumption CFM (L/Min)	Length Inch (mm)	Weight Lbs (Kg)	Noise Level dB(A)
SM-5B-6410/38	12,000	820 (1.1)	4 (100)	3/8"-24	3/8"	3/8 (10)	4 (113)	9.4 (240)	4.4 (2)	90
SM-5C-6410/58	12,000	820 (1.1)	4-1/2 (115)	5/8"-11	3/8"	3/8 (10)	4 (113)	9.4 (240)	4.4 (2)	90
SM-5C-6410/M14	12,000	820 (1.1)	4-1/2 (115)	M14x2.0	3/8"	3/8 (10)	4 (113)	9.4 (240)	4.4 (2)	90
SM-5D-6410/38	12,000	820 (1.1)	5 (125)	3/8"-24	3/8"	3/8 (10)	4 (113)	9.4 (240)	4.4 (2)	90
SM-5D-6410/58	12,000	820 (1.1)	5 (125)	5/8"-11	3/8"	3/8 (10)	4 (113)	9.4 (240)	4.4 (2)	90
SM-5D-6410/M14	12,000	820 (1.1)	5 (125)	M14x2.0	3/8"	3/8 (10)	4 (113)	9.4 (240)	4.4 (2)	90
SM-5B-6410R/38	12,000	820 (1.1)	4 (100)	3/8"-24	3/8"	3/8 (10)	4 (113)	9.2 (234)	4.4 (2)	90
SM-5C-6410R/58	12,000	820 (1.1)	4-1/2 (115)	5/8"-11	3/8"	3/8 (10)	4 (113)	9.2 (234)	4.4 (2)	90
SM-5C-6410R/M14	12,000	820 (1.1)	4-1/2 (115)	M14x2.0	3/8"	3/8 (10)	4 (113)	9.2 (234)	4.4 (2)	90
SM-5D-6410R/38	12,000	820 (1.1)	5 (125)	3/8"-24	3/8"	3/8 (10)	4 (113)	9.2 (234)	4.4 (2)	90
SM-5D-6410R/58	12,000	820 (1.1)	5 (125)	5/8"-11	3/8"	3/8 (10)	4 (113)	9.2 (234)	4.4 (2)	90
SM-5D-6410R/M14	12,000	820 (1.1)	5 (125)	M14x2.0	3/8"	3/8 (10)	4 (113)	9.2 (234)	4.4 (2)	90

* Recommended Air Pressure at 90 PSI (6.2 Bar)

Angle Grinders - Heavy Industrial

Features:

- **With Speed Governor**
- 9 Position Adjustable Swivel Guard
- Accept **0.8 mm~6 mm Disc**
- Built-in Comfort Grip
- Side Handle
- Rear Exhaust
- Vibration Reduced Handle (Optional)
- **1.1 HP Motor**

SM-5B-6410S

4" Angle Grinder

SM-5C-6410S

4-1/2" Angle Grinder

SM-5D-6410S

5" Angle Grinder

- **Swivel Guard**
- **1.1 HP**



EH-5D-6410-11SUB
Exhaust Hose Assembly (Optional)

▼ 9 Position Adjustable Swivel Guard



#5D-619256
Standard Side Handle



#5G-619753
Vibration Reduced Handle (Optional)



QN-38
Quick Nut (3/8"-24UNF)



QN-M14
Quick Nut (M14x2.0P)



QN-58
Quick Nut (5/8"-11UNC)

▲ Suitable for 4-1/2" & 5" Type 41 Wheel Only (Optional)

Specifications:

Model No.	Free Speed (RPM)	Power Watt (HP)	Capacity Wheel Inch (mm)	Spindle Thread	Air Inlet (NPT)	Hose Size ID Inch (mm)	Air Consumption CFM (L/Min)	Length Inch (mm)	Weight Lbs (Kg)	Noise Level dB(A)
SM-5B-6410S/38	12,000	820 (1.1)	4 (100)	3/8"-24	3/8"	3/8 (10)	4 (113)	9.8 (249)	4.4 (2)	90
SM-5C-6410S/58	12,000	820 (1.1)	4-1/2 (115)	5/8"-11	3/8"	3/8 (10)	4 (113)	9.8 (249)	4.4 (2)	90
SM-5C-6410S/M14	12,000	820 (1.1)	4-1/2 (115)	M14x2.0	3/8"	3/8 (10)	4 (113)	9.8 (249)	4.4 (2)	90
SM-5D-6410S/38	12,000	820 (1.1)	5 (125)	3/8"-24	3/8"	3/8 (10)	4 (113)	9.8 (249)	4.4 (2)	90
SM-5D-6410S/58	12,000	820 (1.1)	5 (125)	5/8"-11	3/8"	3/8 (10)	4 (113)	9.8 (249)	4.4 (2)	90
SM-5D-6410S/M14	12,000	820 (1.1)	5 (125)	M14x2.0	3/8"	3/8 (10)	4 (113)	9.8 (249)	4.4 (2)	90

* Recommended Air Pressure at 90 PSI (6.2 Bar)

Angle Grinders

Features:

- **With Speed Governor**
- 9 Position Adjustable Swivel Guard
- Accept **0.8 mm~6 mm Disc**
- Built-in Comfort Grip
- Side Handle
- Spindle Lock Allows Quick and Easy Disc Change
- Rear Exhaust
- Vibration Reduced Handle (Optional)
- **Low Noise 83 dB(A)**
- **0.9 HP Motor**



▲ Vibration Reduced Handle



▲ Swivel Guard Adjustable



SM-5B-6192A

4" Angle Grinder - without Swivel Guard

SM-5C-6192A

4-1/2" Angle Grinder - without Swivel Guard

SM-5D-6192A

5" Angle Grinder - without Swivel Guard

SM-5B-6192AS
4" Angle Grinder

SM-5C-6192AS
4-1/2" Angle Grinder

SM-5D-6192AS
5" Angle Grinder

▼ 9 Position Adjustable Swivel Guard



Patent No.

TW M281747 / M291340 / M336110

#5D-619256
Standard Side Handle

#5G-619753
Vibration Reduced Handle (Optional)

EH-6192SUB
Exhaust Hose Assembly (Optional)

QN-38
Quick Nut (3/8"-24UNF)

QN-M14
Quick Nut (M14x2.0P)

QN-58
Quick Nut (5/8"-11UNC)

▲ Suitable for 4-1/2" & 5" Type 41 Wheel Only (Optional)

Specifications:

Model No.	Free Speed (RPM)	Grinding Wheel Size Inch (mm)	Spindle Thread	Air Inlet (NPT)	Hose Size ID Inch (mm)	Air Consumption CFM (L/Min)	Length Inch (mm)	Weight Lbs (Kg)	Noise Level dB(A)
SM-5B-6192AS/38	12,000	4 (100)	3/8"-24	1/4"	3/8 (10)	4 (113)	9.4 (239)	4.4 (2)	83
SM-5B-6192AS/M10	12,000	4 (100)	M10x1.5	1/4"	3/8 (10)	4 (113)	9.4 (239)	4.4 (2)	83
SM-5C-6192AS/58	12,000	4-1/2 (115)	5/8"-11	1/4"	3/8 (10)	4 (113)	9.4 (239)	4.4 (2)	83
SM-5C-6192AS/M14	12,000	4-1/2 (115)	M14x2.0	1/4"	3/8 (10)	4 (113)	9.4 (239)	4.4 (2)	83
SM-5C-6192AS/38	12,000	4-1/2 (115)	3/8"-24	1/4"	3/8 (10)	4 (113)	9.4 (239)	4.4 (2)	83
SM-5D-6192AS/58	12,000	5 (125)	5/8"-11	1/4"	3/8 (10)	4 (113)	9.4 (239)	4.4 (2)	83
SM-5D-6192AS/M14	12,000	5 (125)	M14x2.0	1/4"	3/8 (10)	4 (113)	9.4 (239)	4.4 (2)	83
SM-5D-6192AS/38	12,000	5 (125)	3/8"-24	1/4"	3/8 (10)	4 (113)	9.4 (239)	4.4 (2)	83

* Recommended Air Pressure at 90 PSI (6.2 Bar)

Angle Grinders

Features:

- **With Speed Governor**
- 9 Position Adjustable **Swivel Guard**
- Accept **0.8 mm~6 mm Disc**
- **Composite** Motor Housing
- Side Handle
- **Spindle Lock** Allows Quick and Easy Disc Change
- Rear Exhaust
- Vibration Reduced Handle (Optional)
- **Low Noise 83 dB(A)**
- **0.9 HP Motor**



▲ Spindle Lock



▲ Swivel Guard Adjustable

SM-5B-6192PS

4" Angle Grinder

SM-5C-6192PS

4-1/2" Angle Grinder

SM-5D-6192PS

5" Angle Grinder



▼ 9 Position Adjustable Swivel Guard



#5D-619256

Standard Side Handle



#5G-619753

Vibration Reduced Handle (Optional)



EH-6192SUB

Exhaust Hose Assembly (Optional)



QN-38

Quick Nut (3/8"-24UNF)



QN-M14

Quick Nut (M14x2.0P)



QN-58

Quick Nut (5/8"-11UNC)

▲ Suitable for 4-1/2" & 5" Type 41 Wheel Only (Optional)

Specifications:

Model No.	Free Speed (RPM)	Grinding Wheel Size Inch (mm)	Spindle Thread	Air Inlet (NPT)	Hose Size ID Inch (mm)	Air Consumption CFM (L/Min)	Length Inch (mm)	Weight Lbs (Kg)	Noise Level dB(A)
SM-5B-6192PS/38	12,000	4 (100)	3/8"-24	1/4"	3/8 (10)	4 (113)	9.4 (239)	4.4 (2)	83
SM-5B-6192PS/M10	12,000	4 (100)	M10x1.5	1/4"	3/8 (10)	4 (113)	9.4 (239)	4.4 (2)	83
SM-5C-6192PS/58	12,000	4-1/2 (115)	5/8"-11	1/4"	3/8 (10)	4 (113)	9.4 (239)	4.4 (2)	83
SM-5C-6192PS/M14	12,000	4-1/2 (115)	M14x2.0	1/4"	3/8 (10)	4 (113)	9.4 (239)	4.4 (2)	83
SM-5C-6192PS/38	12,000	4-1/2 (115)	3/8"-24	1/4"	3/8 (10)	4 (113)	9.4 (239)	4.4 (2)	83
SM-5D-6192PS/58	12,000	5 (125)	5/8"-11	1/4"	3/8 (10)	4 (113)	9.4 (239)	4.4 (2)	83
SM-5D-6192PS/M14	12,000	5 (125)	M14x2.0	1/4"	3/8 (10)	4 (113)	9.4 (239)	4.4 (2)	83
SM-5D-6192PS/38	12,000	5 (125)	3/8"-24	1/4"	3/8 (10)	4 (113)	9.4 (239)	4.4 (2)	83

* Recommended Air Pressure at 90 PSI (6.2 Bar)

7" Angle Grinders

Features:

- **Spindle Lock Design**
- Spindle Lock Allows Quick And Easy Disc Change
- Push Button Lock off Lever
- Spindle Thread: **5/8"-11 or M14x2.0**
- Rubber Comfort Grip
- Front Exhaust
- Vibration Reduced Handle (Optional)



▲ Spindle Lock



▲ Front Exhaust



▲ Safety Lever

SM-5G-6197

7" Angle Grinder (8,500 RPM)
- 1.3 HP



- Bigger Guard (USA)

SM-5G-6198

7" Angle Grinder (8,500 RPM)
- 1.3 HP



- Smaller Guard (Europe)

Accessories (Optional) :



#5D-619256
Standard Side Handle



#5G-619753
Vibration Reduced Handle (Optional)

Specifications:

Model No.	Free Speed (RPM)	Grinding Wheel Size Inch (mm)	Spindle Thread	Air Inlet (NPT)	Hose Size ID Inch (mm)	Air Consumption CFM (L/Min)	Length Inch (mm)	Weight Lbs (Kg)
SM-5G-6197/58	8,500	7 (175)	5/8"-11	3/8"	3/8 (10)	6 (170)	13.8 (350)	7.7 (3.5)
SM-5G-6197/M14	8,500	7 (175)	M14x2.0	3/8"	3/8 (10)	6 (170)	13.8 (350)	7.7 (3.5)
SM-5G-6198/58	8,500	7 (175)	5/8"-11	3/8"	3/8 (10)	4 (113)	13.1 (334)	7.3 (3.3)
SM-5G-6198/M14	8,500	7 (175)	M14x2.0	3/8"	3/8 (10)	4 (113)	13.1 (334)	7.3 (3.3)

* Recommended Air Pressure at 90 PSI (6.2 Bar)

Angle Grinders & Sander

SM-6190

4-1/2" Angle Grinder & Sander



#619041-11

4-1/2" Plastic Pad (Optional)



SM-619 / SM-619A

4" Angle Grinder

SM-6194 / SM-6194B

4-1/2" Angle Grinder

SM-6195 / SM-6195A / SM-6195B

5" Angle Grinder



Specifications:

Model No.	Free Speed (RPM)	Disc Size Inch (mm)	Spindle Thread	Air Inlet (NPT)	Hose Size ID Inch (mm)	Air Consumption CFM (L/Min)	Length Inch (mm)	Weight Lbs (Kg)
SM-6190	12,000	4-1/2 (115)	M10 x 1.5	1/4"	3/8 (10)	6 (170)	8.8 (223)	4 (1.8)
SM-619	12,000	4 (102)	3/8"-24	1/4"	3/8 (10)	6 (170)	8.8 (224)	4 (1.8)
SM-619A	12,000	4 (102)	M10 x 1.5	1/4"	3/8 (10)	6 (170)	8.8 (224)	4 (1.8)
SM-6194	12,000	4-1/2 (115)	3/8"-24	1/4"	3/8 (10)	6 (170)	8.8 (224)	4 (1.8)
SM-6194B	12,000	4-1/2 (115)	5/8"-11	1/4"	3/8 (10)	6 (170)	8.8 (224)	4 (1.8)
SM-6195	12,000	5 (127)	3/8"-24	1/4"	3/8 (10)	6 (170)	8.8 (224)	4.2 (1.9)
SM-6195A	12,000	5 (127)	M14 x 2.0	1/4"	3/8 (10)	6 (170)	8.8 (224)	4.2 (1.9)
SM-6195B	12,000	5 (127)	5/8"-11	1/4"	3/8 (10)	6 (170)	8.8 (224)	4.2 (1.9)

* Recommended Air Pressure at 90 PSI (6.2 Bar)

7" Angle Sanders & Polishers

Features:

- New Built-in Comfort Grip
- Safety Lever
- Spindle Lock Button
- Rear Exhaust
- Vibration Reduced
- Side Handle (Optional)



▲ Spindle Lock Button

SM-67-6661

7" Angle Sander (4,500 RPM)



SM-6N-6661

7" Angle Polisher (2,500 RPM)
(Wool polisher not included)



Accessories (Optional) :



#5G-619753
Vibration Reduced Side Handle



#6N-666132
7" Plastic Pad (included with tool)



#6N-666131
Wool Polishing Pad



#610227V-62
(5/8"-11 thread)
#610227V-63
(M14x2.0 thread)



#6N-666125V-72
(5/8"-11 thread)
#6N-666125V-73
(M14x2.0 thread)



#6N-666125V-82
(5/8"-11 thread)
#6N-666125V-83
(M14x2.0 thread)

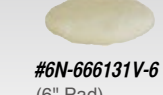

#6N-666131V-6
(6" Pad)
#6N-666131V-7
(7" Pad)
#6N-666131V-8
(8" Pad)

Specifications:

Model No.	Free Speed (RPM)	Pad Size Inch (mm)	Spindle Thread	Air Inlet (NPT)	Hose Size ID Inch (mm)	Air Consumption CFM (L/Min)	Length Inch (mm)	Weight Lbs (Kg)
SM-67-6661/58	4,500	7(175)	5/8" - 11	1/4"	3/8(10)	3.2 (91)	12 (307)	4.2 (1.9)
SM-67-6661/M14	4,500	7(175)	M14 x 2.0	1/4"	3/8(10)	3.2 (91)	12 (307)	4.2 (1.9)
SM-6N-6661/58	2,500	7(175)	5/8" - 11	1/4"	3/8(10)	3.2 (91)	12 (307)	4.2 (1.9)
SM-6N-6661/M14	2,500	7(175)	M14 x 2.0	1/4"	3/8(10)	3.2 (91)	12 (307)	4.2 (1.9)

* Recommended Air Pressure at 90 PSI (6.2 Bar)

Water Feed Tool Series

SM-5M-130W

Air Wet Stone Cutter (13,000 RPM)



Accessories (Optional) :



#5M-130W35-1

Getter Blade (110 x 20 mm)

Specifications:

Model No.	Free Speed (RPM)	Cutting Wheel Size Inch (mm)	Air Inlet (NPT)	Hose Size ID Inch (mm)	Air Consumption CFM (L/Min)	Length Inch (mm)	Weight Lbs (Kg)	Noise Level dB(A)
SM-5M-130W	13,000	4-1/2 (110)	1/4	3/8 (10)	5 (142)	9.2 (234)	4.9 (2.2)	80

* Recommended Air Pressure at 90 PSI (6.2 Bar)

SM-5D-6192AW

5" Air Wet Angle Sander (10,000 RPM)
(Pad not included)



▲ Water Feed



SM-5G-6197W

7" Air Wet Angle Sander (6,000 RPM)
(Pad not included)



▲ Water Feed Type Regulator



Available Pad Size : 3", 4" or 5"

▲ Water Feed Type Regulator

SM-618W

5" Air Wet Stone Sander / Polisher (1,800 RPM)

SM-642W

5" Air Wet Stone Sander / Polisher (4,200 RPM)

SM-680W

5" Air Wet Stone Sander / Polisher (8,000 RPM)

SM-611W

5" Air Wet Stone Sander / Polisher (11,000 RPM)

Specifications:

Model No.	Free Speed (RPM)	Pad Size Inch (mm)	Spindle Thread	Air Inlet (NPT)	Hose Size ID Inch (mm)	Air Consumption CFM (L/Min)	Length Inch (mm)	Weight Lbs (Kg)
SM-5D-6192AW	10,000	5 (125)	M14x2.0	1/4	3/8 (10)	4 (113)	10.6 (270)	4.6 (2.1)
SM-5G-6197W	6,000	7 (180)	5/8"-11	1/4	3/8 (10)	4 (113)	15.4 (390)	8.6 (3.9)
SM-618W/58	1,800	5 (125)	5/8"-11	1/4	3/8 (10)	4 (113)	13.8 (350)	4.9 (2.2)
SM-618W/M14	1,800	5 (125)	M14x2.0	1/4	3/8 (10)	4 (113)	13.8 (350)	4.9 (2.2)
SM-642W/58	4,200	5 (125)	5/8"-11	1/4	3/8 (10)	4 (113)	13.8 (350)	4.9 (2.2)
SM-642W/M14	4,200	5 (125)	M14x2.0	1/4	3/8 (10)	4 (113)	13.8 (350)	4.9 (2.2)
SM-680W/58	8,000	5 (125)	5/8"-11	1/4	3/8 (10)	4 (113)	13.8 (350)	4.9 (2.2)
SM-680W/M14	8,000	5 (125)	M14x2.0	1/4	3/8 (10)	4 (113)	13.8 (350)	4.9 (2.2)
SM-611W/58	11,000	5 (125)	5/8"-11	1/4	3/8 (10)	4 (113)	13.8 (350)	4.9 (2.2)
SM-611W/M14	11,000	5 (125)	M14x2.0	1/4	3/8 (10)	4 (113)	13.8 (350)	4.9 (2.2)

* Recommended Air Pressure at 90 PSI (6.2 Bar)

Angle Sander, Angle Grinder, Angle Die Grinder, Cut-Off Tools

Features:

- **Spindle Lock Design**
- 126° - 8 Position Adjustable Swivel Guard
- Good for Grinding or Cutting
- Rubber molded Cushion Grip
- Rear Exhaust
- Vibration Reduced Handle (Optional)

Patent No.

TW M320458 / M336110 / M281747



SM-65-3271

5" Angle Sander



SM-5B-3271

4" Angle Grinder & Cut-Off Tool

1.0 HP

SM-5C-3271

4-1/2" Angle Grinder & Cut-Off Tool



SM-5D-3271

5" Angle Grinder & Cut-Off Tool



▲ 126° - 8 Position Adjustable Swivel Guard

SM-5D-3272

5" Angle Grinder & Cut-Off Tool

- Spindle Thread : 5/8"-11
- Non-Swivel Guard

1.0 HP



Features:

- Rubber Molded Cushion Grip
- Rear Exhaust
- **0.7 HP Motor**

SM-52-3271

1/4" Angle Die Grinder



Specifications:

Model No.	Free Speed (RPM)	Disc (or Pad, Collet) Size Inch (mm)	Disc Hole Size Inch (mm)	Spindle Thread	Air Inlet (NPT)	Hose Size ID Inch (mm)	Air Consumption CFM (L/Min)	Length Inch (mm)	Weight Lbs (Kg)	Power HP (Kw)	Noise Level dB(A)
SM-65-3271	9,000	5 (125)	-	5/8"-11	1/4"	3/8 (10)	4 (113)	10.5 (266)	3.5 (1.6)	0.7 (0.52)	84
SM-5B-3271	12,000	4 (100)	5/8" (16)	3/8"-24	1/4"	3/8 (10)	4 (113)	10.6 (268)	3.7 (1.7)	1.0 (0.7)	84
SM-5C-3271	12,000	4-1/2 (115)	5/8" (16)	3/8"-24	1/4"	3/8 (10)	4 (113)	10.6 (268)	3.7 (1.7)	1.0 (0.7)	84
SM-5D-3271	12,000	5 (125)	5/8" (16)	3/8"-24	1/4"	3/8 (10)	4 (113)	10.6 (268)	3.7 (1.7)	1.0 (0.7)	84
SM-5D-3272	12,000	5 (125)	5/8" (16)	5/8"-11	1/4"	3/8 (10)	4 (113)	10.6 (268)	3.7 (1.7)	1.0 (0.7)	84
SM-52-3271	11,000	1/4 (6)	-	-	1/4"	3/8 (10)	4 (113)	10.5 (266)	3.1 (1.4)	0.7 (0.52)	84

* Recommended Air Pressure at 90 PSI (6.2 Bar)

Mini Angle Grinder & Kit

Features:

- **Comfort Grip**
- Side Exhaust
- Safety Throttle Lever
- **Low Noise 81 dB(A)**

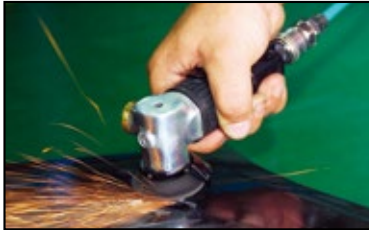

▲ Grinding Operation



▲ Operation of Mini Angle Grinder

SM-6542 2" Mini Angle Grinder



SM-6542K 2" Mini Angle Grinder Kit



Kit Includes:



SM-6542
2" Mini Angle Grinder x 1
Installed with
#60 Grit Grinding Wheel



PK-SG2618
Safety Glasses x 1

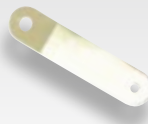

#5A-7283A40
Pin Wrench x 1



#654248-11
Spanner Wrench x 1



SA-7283560
#60 Grit 2" Grinding Wheel x 3

SA-7283580
#80 Grit 2" Grinding Wheel x 3

SA-72835120
#120 Grit 2" Grinding Wheel x 3

Specifications:

Model No.	Free Speed (RPM)	Grinding Wheel Size Inch (mm)	Spindle Thread	Air Inlet (NPT)	Hose Size ID Inch (mm)	Air Consumption CFM (L/Min)	Length Inch (mm)	Weight Lbs (Kg)	Noise Level dB(A)
SM-6542	20,000	2 (50)	3/8"-24	1/4"	3/8 (10)	4 (113)	5 (129)	1.1 (0.5)	81

* Recommended Air Pressure at 90 PSI (6.2 Bar)

Mini Angle Grinder / Cut-Off Tool

Features:

- **Special Spindle**
(Accept 2" Grinding Wheel & 2" Cutting Wheel)
- Comfort Grip
- Side Exhaust
- Safety Throttle Lever
- **Low Noise 81 dB(A)**



▲ Operation of Cutting Metal Plate



▲ Operation of Cutting Metal Plate



2" Angle Grinder



2" Cut-Off Tool

SM-5J-5423

2" Mini Angle Grinder & Cut-Off Tool



SM-5J-5423K

2" Mini Angle Grinder & Cut-Off Tool Kit



SA-7283560

#60 Grit 2" Grinding Wheel x 3

SA-7283580

#80 Grit 2" Grinding Wheel x 3

SA-72835120

#120 Grit 2" Grinding Wheel x 3

Kit Includes:



SM-5J-5423

2" Angle Grinder & Cut-off Tool x 1
Installed with #60 Grit Grinding Wheel



PK-SG2618

Safety Glasses x 1

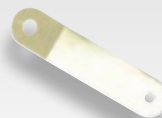

#5A-7283A40

Pin Wrench x 1



#654248-11

Spanner Wrench x 1

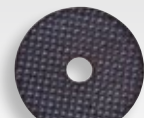

#5J-542007

2" Cutting Wheel x 5

Specifications:

Model No.	Free Speed (RPM)	Grinding & Cutting Wheel Size Inch (mm)	Spindle Thread	Air Inlet (NPT)	Hose Size ID Inch (mm)	Air Consumption CFM (L/Min)	Length Inch (mm)	Weight Lbs (Kg)	Noise Level dB(A)
SM-5J-5423	20,000	2 (50)	3/8"-24	1/4"	3/8 (10)	4 (113)	5 (129)	1.1 (0.5)	81

* Recommended Air Pressure at 90 PSI (6.2 Bar)

Mini Cut-Off Tools

Features:

- Rubber Comfort Grip
- Side Exhaust
- Safety Throttle Lever
- **Low Noise 81 dB(A)**



▲ Operation of SM-5J-5420



▲ Operation of SM-5J-5420

SM-5J-5420 2" Mini Cut-Off Tool



Features:

- Compact 180 Degree Disc Guard
- Handle Exhaust
- Safety Throttle Lever
- Rubber Comfort Grip
- **0.6 HP Motor**



▲ Operation of SM-5K-6200



▲ Operation of SM-5K-6200

SM-5K-6200 3" Cut-Off Tool



Specifications:

Model No.	Free Speed (RPM)	Cutting Wheel Size Inch (mm)	Air Inlet (NPT)	Hose Size ID Inch (mm)	Air Consumption CFM (L/Min)	Length Inch (mm)	Weight Lbs (Kg)	Power HP (Kw)	Noise Level dB(A)
SM-5J-5420	20,000	2 (50)	1/4	3/8 (10)	4 (113)	5 (129)	1.1 (0.5)	-	81
SM-5K-6200	18,000	3 (75)	1/4	3/8 (10)	4 (113)	9 (227)	2.0 (0.93)	0.6 (0.45)	-

* Recommended Air Pressure at 90 PSI (6.2 Bar)

Features:

- Push Button Adjustable Guard
- **126° - 8 Position Adjustable Swivel Guard**
- Rubber molded Cushion Grip
- Rear Exhaust
- **0.7 HP Motor**



► Operation of Cut-Off Tool



► Operation of Corner Grinder

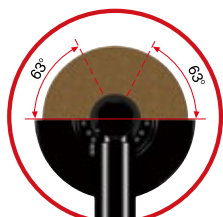

8 Positions for Guard Adjustment (126° Adjustable)



Push to Adjust Guard



Flat Air Regulator on Top

Patent No.

US D566, 502 S
 DE 20 2006 016 578 U1
 TW M302447 / M308838 / M330148
 M281747 / D121416 / D121417

SM-5L-2011L
4" Extended Cut-Off Tool

SM-5K-3011B
3" Cut-Off Tool - Long Neck

SM-5L-3011B
4" Cut-Off Tool - Long Neck

SM-5K-3011S
3" Cut-Off Tool

SM-5L-3011S
4" Cut-Off Tool

Specifications:

Model No.	Free Speed (RPM)	Cutting Wheel Size Inch (mm)	Disc Hole Size Inch (mm)	Air Inlet (NPT)	Hose Size ID Inch (mm)	Air Consumption CFM (L/Min)	Length Inch (mm)	Weight Lbs (Kg)	Power HP (Kw)
SM-5L-2011L	17,000	4 (100)	3/8 (10)	1/4"	3/8 (10)	4 (113)	14.6 (370)	3.7 (1.7)	0.7 (0.52)
SM-5K-3011B	17,000	3 (75)	3/8 (10)	1/4"	3/8 (10)	4 (113)	11 (279)	3.1 (1.4)	0.7 (0.52)
SM-5L-3011B	17,000	4 (100)	3/8 (10)	1/4"	3/8 (10)	4 (113)	11 (279)	3.1 (1.4)	0.7 (0.52)
SM-5K-3011S	17,000	3 (75)	3/8 (10)	1/4"	3/8 (10)	4 (113)	9.6 (243)	2.6 (1.2)	0.7 (0.52)
SM-5L-3011S	17,000	4 (100)	3/8 (10)	1/4"	3/8 (10)	4 (113)	9.6 (243)	2.6 (1.2)	0.7 (0.52)

* Recommended Air Pressure at 90 PSI (6.2 Bar)

Cut-Off Tool

Features:

- **Spindle Lock Design**
- **Rear Exhaust**
- **Built-in Cushion Grip**
- **Push to Adjust Guard**
- **11 Positions Adjustable Swivel Guard**
(126° Adjustable)
- **1.0 HP**

SM-5L-5200

4" Extended Cut-Off Tool

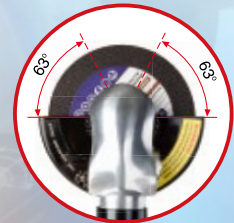

11 Positions for Guard Adjustment
(126° Adjustable)



Push to Adjust Guard



Patent No.

US 8,939,816 B2
DE 20 2012 102 406 U1
TW M435541 / M436553 / M460746 / M460757

Specifications:

Model No.	Free Speed (RPM)	Cutting Wheel Size Inch (mm)	Disc Hole Size Inch (mm)	Air Inlet (NPT)	Hose Size ID Inch (mm)	Air Consumption CFM (L/Min)	Length Inch (mm)	Weight Lbs (Kg)	Power HP (Kw)	Remark
SM-5L-5200/38	14,000	4 (100)	3/8 (9.5)	1/4"	3/8 (10)	4 (113)	14.6 (371)	3.7 (1.7)	1.0 (0.7)	-
* SM-5L-5200/10	14,000	4 (100)	10 mm	1/4"	3/8 (10)	4 (113)	14.6 (371)	3.7 (1.7)	1.0 (0.7)	-
SM-5L-5200/15	14,000	4 (100)	15 mm	1/4"	3/8 (10)	4 (113)	14.6 (371)	3.7 (1.7)	1.0 (0.7)	for Japan
SM-5L-5200/16	14,000	4 (100)	5/8 (16)	1/4"	3/8 (10)	4 (113)	14.6 (371)	3.7 (1.7)	1.0 (0.7)	-

* Recommended Air Pressure at 90 PSI (6.2 Bar)

3" Reversible Cut-Off Tools

Features:

- Special Hub Allows for Left or Right Turning Cutting Wheel
- Collar Operated Easy Directional Change
- Safety Throttle Lever
- Rear Exhaust
- **0.85 HP Motor**



▲ Direction of Reverse



▲ Direction of Forward



Special Hub Allows for Left or Right Turning Cutting Wheel



SM-5J-8423
3" Reversible Cut-Off tool



SM-5J-8424
3" Reversible Cut-Off tool

Patent No.

TW 223988 / M380214
US 6813837

Specifications:

Model No.	Free Speed (RPM)	Cutting Wheel Size Inch (mm)	Air Inlet (NPT)	Hose Size ID Inch (mm)	Air Consumption CFM (L/Min)	Length Inch (mm)	Weight Lbs (Kg)	Noise Level dB(A)
SM-5J-8423	20,000	3 (75)	1/4"	3/8 (10)	4 (113)	8 (204)	2 (0.9)	85
SM-5J-8424	20,000	3 (75)	1/4"	3/8 (10)	4 (113)	8 (204)	2 (0.9)	85

* Recommended Air Pressure at 90 PSI (6.2 Bar)

3" Reversible Cut-Off Tools & Kit

Features:

- **Reversing Lever**
(Reverses to direct sparks & debris away from the operator)
- **Patented Hub** (Design for reversing function)
- **Compact Disc Guard**
- Built-in Cushion Grip
- Safety Throttle Lever
- Rotating Air Inlet



▲ Direction of Forward



▲ Direction of Reverse



Reversing Lever



Hub for Reversible

SM-5265R 3" Reversible Cut-Off Tool



SM-5263R 3" Reversible Cut-Off Tool



SM-5265RK Reversible Cut-Off Tool Kit

Kit Includes:



#51228
Double Ended
Spanner Wrench x 2



#10014
Hex Key Wrench x 1
(4.0 x 70L)



SM-5265R
3" Reversible Cut-Off Tool x 1

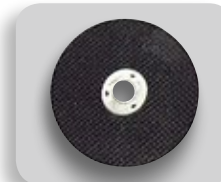

#52630
3" Cutting Wheel x 10



PK-SG2618
Safety Glasses x 1

Patent No.
US 6813837 / TW 223988

Specifications:

Model No.	Free Speed (RPM)	Cutting Wheel Size Inch (mm)	Air Inlet (NPT)	Hose Size ID Inch (mm)	Air Consumption CFM (L/Min)	Length Inch (mm)	Weight Lbs (Kg)
SM-5263R	18,000	3 (75)	1/4"	3/8 (10)	4 (113)	7.2 (183)	2 (0.9)
SM-5265R	18,000	3 (75)	1/4"	3/8 (10)	4 (113)	7.2 (183)	2 (0.9)

* Recommended Air Pressure at 90 PSI (6.2 Bar)



6" Sanding Pad

Sanding Pad

Max. 12,000 RPM

SUNTECH

SUNTECH

SUNTECH

ON DAILY



Wash the Old Battery
Remove the Old Battery
Install the New Battery
Recharge the New Battery

ON DAILY



1-1/4" Mini Random Orbital Nib Sander

Features:

- Composite Motor Housing
- Orbit Diameter: **3/16"** (5 mm)
- Well-Balanced
- Low Vibration
- Roloc Sanding Pad
- PSA Style Pad
- **Lightweight 0.5 kg**

SM-61-6133

1-1/4" Mini Random Orbital Nib Sander
- Orbit Dia. 3/16" (5 mm)



Roloc Type Pad

Specifications:

Model No.	Max. Free Speed (RPM)	Orbit Diameter Inch (mm)	Pad Size Inch (mm)	Spindle Thread	Air Inlet (NPT)	Hose Size ID Inch (mm)	Air Consumption CFM (L/Min)	Length Inch (mm)	Weight Lbs (Kg)
SM-61-6133	8,000	3/16 (5)	1-1/4 (32)	Locking Type	1/4"	3/8 (10)	2 (57)	5.2 (131)	1.1 (0.5)

* Recommended Air Pressure at 90 PSI (6.2 Bar)

Random Orbital Palm Sander

Features:

- Composite Motor Housing
- Powerful Dust Extraction
- One-hand Speed Control
- Well-balanced and Low Vibration
- Lightweight
- Low Noise



Central-Vacuum

SM-63-6143C

3" Random Orbital Palm Sander
- Orbit Dia. 5 mm

SM-63-6243C

3" Random Orbital Palm Sander
- Orbit Dia. 2.5 mm

Self-Vacuum

SM-63-6143A

3" Random Orbital Palm Sander
- Orbit Dia. 5 mm

SM-63-6243A

3" Random Orbital Palm Sander
- Orbit Dia. 2.5 mm



Specifications:

Model No.	Max. Free Speed (RPM)	Orbit Diameter Inch (mm)	Pad Size Inch (mm)	Spindle Thread	Air Inlet (NPT)	Hose Size ID Inch (mm)	Air Consumption CFM (L/Min) Free Speed	Length Inch (mm)	Weight Lbs (Kg)	Power Watt (HP)	Noise Level dB(A)
SM-63-6143C	12,000	3/16 (5)	3 (77)	1/4"-20	1/4"	1/4 (6)	17 (480)	8.1 (205)	1.1 (0.5)	209 (0.28)	76
SM-63-6243C	12,000	3/32 (2.5)	3 (77)	1/4"-20	1/4"	1/4 (6)	17 (480)	8.1 (205)	1.1 (0.5)	209 (0.28)	76
SM-63-6143A	12,000	3/16 (5)	3 (77)	1/4"-20	1/4"	1/4 (6)	17 (480)	8.1 (205)	1.1 (0.5)	209 (0.28)	84
SM-63-6243A	12,000	3/32 (2.5)	3 (77)	1/4"-20	1/4"	1/4 (6)	17 (480)	8.1 (205)	1.1 (0.5)	209 (0.28)	84

* Recommended Air Pressure at 90 PSI (6.2 Bar)

Nib Removal Sanders

Features:

- Small Diameter Head Size for Better Visibility, Less Buffing
- Lightweight, Easy-Grip, Right Angle Tool
- Better Visibility, Less Buffing
- Precise Speed Control
- Rear Exhaust with Available Overhose
- **Roloc Type Pad**



SM-61-5235

Nib Removal Sander

- Orbit Dia. 3 mm

SM-61-5236

Nib Removal Sander

- Orbit Dia. 3 mm

Specifications:

Model No.	Max. Free Speed (RPM)	Pad Size Inch (mm)	Orbit Diameter Inch (mm)	Air Inlet (NPT)	Hose Size ID Inch (mm)	Air Consumption CFM (L/Min)	Length Inch (mm)	Weight Lbs (Kg)	Noise Level dB(A)
SM-61-5235	12,000	1-1/4 (32)	1/8 (3)	1/4"	3/8 (10)	1 (28.3)	7.8 (199)	1.3 (0.6)	80
SM-61-5236	12,000	1-1/4 (32)	1/8 (3)	1/4"	3/8 (10)	1 (28.3)	7.8 (199)	1.3 (0.6)	80

* Recommended Air Pressure at 90 PSI (6.2 Bar)

3" Buffers

Features:

- Lightweight **1.0 Kg**
- Low Noise **82 dB(A)**



G5-513257
Hook (Optional)

SM-63-5432

3" Buffer - **Oil-Free**
- Orbit Dia. 14 mm



SM-63-6432

3" Buffer
- Orbit Dia. 14 mm



SM-63-5137

3" Buffer - **Oil-Free**
- Orbit Dia. 5 mm

SM-63-5237

3" Buffer - **Oil-Free**
- Orbit Dia. 2.5 mm

SM-63-5437

3" Buffer - **Oil-Free**
- Orbit Dia. 14 mm



SM-63-6133

3" Buffer
- Orbit Dia. 5 mm

SM-63-6233

3" Buffer
- Orbit Dia. 2.5 mm

SM-63-6433

3" Buffer
- Orbit Dia. 14 mm



Specifications:

Model No.	Max. Free Speed (RPM)	Pad Size Inch (mm)	Orbit Diameter Inch (mm)	Spindle Thread	Air Inlet (NPT)	Hose Size ID Inch (mm)	Air Consumption CFM (L/Min)	Length Inch (mm)	Weight Lbs (Kg)	Noise Level dB(A)
SM-63-5432	12,000	3 (75)	9/16 (14)	5/16"-24	1/4"	3/8 (10)	3 (85)	9.9 (252)	2.2 (1.0)	82
SM-63-6432	12,000	3 (75)	9/16 (14)	5/16"-24	1/4"	3/8 (10)	3 (85)	9.9 (252)	2.2 (1.0)	82
SM-63-5137	12,000	3 (75)	3/16 (5)	5/16"-24	1/4"	3/8 (10)	2 (57)	5.2 (132)	1.4 (0.6)	76
SM-63-5237	12,000	3 (75)	3/32 (2.5)	5/16"-24	1/4"	3/8 (10)	2 (57)	5.2 (132)	1.4 (0.6)	76
SM-63-5437	12,000	3 (75)	9/16 (14)	5/16"-24	1/4"	3/8 (10)	2 (57)	5.2 (132)	1.4 (0.6)	76
SM-63-6133	12,000	3 (75)	3/16 (5)	5/16"-24	1/4"	3/8 (10)	2 (57)	5.2 (132)	1.4 (0.6)	76
SM-63-6233	12,000	3 (75)	3/32 (2.5)	5/16"-24	1/4"	3/8 (10)	2 (57)	5.2 (132)	1.4 (0.6)	76
SM-63-6433	12,000	3 (75)	9/16 (14)	5/16"-24	1/4"	3/8 (10)	2 (57)	5.2 (132)	1.4 (0.6)	76

* Recommended Air Pressure at 90 PSI (6.2 Bar)

3", 4" & 5" Gear-Driven Sanders / Polishers

Features:

- One or Two-Hand Operation
- Orbit Diameter: **5 mm**
- Lightweight **1.0 kg**
- Low Noise **84 dB(A)**

Accessories (Optional) :



G5-513257
Hook



#6N-663636-11
#80 Grit
5" White Compounding Pad - Velcro



#6N-663637-11
#70 Grit
5" Yellow Compounding Pad - Velcro



G4-513243-11
#80 Grit
4" White Compounding Pad - Velcro



G4-513244-11
#70 Grit
4" Yellow Compounding Pad - Velcro



SA-75543VC
3" Yellow Compounding Pad - Velcro



SA-75653VC
3" White Compounding Pad - Velcro

SM-G3-6132

3" Gear-Driven Sander/Polisher



Geared

SM-G3-5132

3" Gear-Driven Sander / Polisher - *Oil-free*



Geared

SM-G4-6132

4" Gear-Driven Sander/Polisher



Geared

SM-G4-5132

4" Gear-Driven Sander / Polisher - *Oil-free*



Geared

SM-G5-6132

5" Gear-Driven Sander/Polisher



Geared

SM-G5-5132

5" Gear-Driven Sander / Polisher - *Oil-free*



Geared

Specifications:

Model No.	Free Speed (RPM)	Pad Size Inch (mm)	Orbit Diameter Inch (mm)	Air Inlet (NPT)	Hose Size ID Inch (mm)	Air Consumption CFM (L/Min)	Length Inch (mm)	Weight Lbs (Kg)	Noise Level dB(A)
SM-G3-6132	1,300	3 (75)	3/16 (5)	1/4"	3/8 (10)	3 (85)	10 (252)	2.2 (1.0)	84
SM-G3-5132	1,300	3 (75)	3/16 (5)	1/4"	3/8 (10)	3 (85)	10 (252)	2.2 (1.0)	84
SM-G4-6132	1,300	4 (100)	3/16 (5)	1/4"	3/8 (10)	3 (85)	10 (252)	2.2 (1.0)	84
SM-G4-5132	1,300	4 (100)	3/16 (5)	1/4"	3/8 (10)	3 (85)	10 (252)	2.2 (1.0)	84
SM-G5-6132	1,300	5 (125)	3/16 (5)	1/4"	3/8 (10)	3 (85)	10 (252)	2.2 (1.0)	84
SM-G5-5132	1,300	5 (125)	3/16 (5)	1/4"	3/8 (10)	3 (85)	10 (252)	2.2 (1.0)	84

* Recommended Air Pressure at 90 PSI (6.2 Bar)

5" & 6" Two-Hand Sanders

Features:

- One or Two-Hand Operation
- Orbit Diameter: **5 mm & 10 mm**
- Swivel Hose Connector
- Lightweight **1.0 kg**
- Low Noise **84 dB(A)**



G5-513257
Hook (Optional)

Patent No.

TAIWAN NO. D116828 / M304400

SM-65-6132

5" Two-Hand Sanders
- Orbit Dia. 5 mm

SM-66-6032

6" Two-Hand Sanders
- Orbit Dia. 10 mm

SM-66-6132

6" Two-Hand Sanders
- Orbit Dia. 5 mm

Non-Vacuum



SM-65-6132A

5" Two-Hand Sanders
- Orbit Dia. 5 mm

SM-66-6032A

6" Two-Hand Sanders
- Orbit Dia. 10 mm

SM-66-6132A

6" Two-Hand Sanders
- Orbit Dia. 5 mm

Dust Free Type



Oil-Free Two-Hand Sanders

Features:

- One or Two-Hand Operation
- Orbit Diameter: **5 mm & 10 mm**
- Swivel Hose Connector
- Lightweight **1.0 kg**
- Low Noise **84 dB(A)**



EH-6133ASUB
Exhaust Hose Assembly
(Optional)
(I.D. : 25.4mm ; O.D. : 33.4mm)



G5-513257
Hook (Optional)

SM-65-5132

5" Two-Hand Sanders
- Orbit Dia. 5 mm

SM-66-5032

6" Two-Hand Sanders
- Orbit Dia. 10 mm

SM-66-5132

6" Two-Hand Sanders
- Orbit Dia. 5 mm

Non-Vacuum



SM-65-5132A

5" Two-Hand Sanders
- Orbit Dia. 5 mm

SM-66-5032A

6" Two-Hand Sanders
- Orbit Dia. 10 mm

SM-66-5132A

6" Two-Hand Sanders
- Orbit Dia. 5 mm

Dust Free Type



Specifications:

Model No.	Max. Free Speed (RPM)	Pad Size Inch (mm)	Orbit Diameter Inch (mm)	Air Inlet (NPT)	Hose Size ID Inch (mm)	Air Consumption CFM (L/Min)	Length Inch (mm)	Weight Lbs (Kg)	Noise Level dB(A)
SM-65-6132	12,000	5 (125)	3/16 (5)	1/4"	3/8 (10)	3 (85)	10.6 (268)	2.2 (1.0)	80
SM-66-6032	12,000	6 (150)	3/8 (10)	1/4"	3/8 (10)	3 (85)	10.6 (268)	2.2 (1.0)	80
SM-66-6132	12,000	6 (150)	3/16 (5)	1/4"	3/8 (10)	3 (85)	10.6 (268)	2.2 (1.0)	80
SM-65-6132A	12,000	5 (125)	3/16 (5)	1/4"	3/8 (10)	3 (85)	10.6 (268)	2.2 (1.0)	84
SM-66-6032A	12,000	6 (150)	3/8 (10)	1/4"	3/8 (10)	3 (85)	10.6 (268)	2.2 (1.0)	84
SM-66-6132A	12,000	6 (150)	3/16 (5)	1/4"	3/8 (10)	3 (85)	10.6 (268)	2.2 (1.0)	84
SM-65-5132	12,000	5 (125)	3/16 (5)	1/4"	3/8 (10)	3 (85)	10.6 (268)	2.2 (1.0)	80
SM-66-5032	12,000	6 (150)	3/8 (10)	1/4"	3/8 (10)	3 (85)	10.6 (268)	2.2 (1.0)	80
SM-66-5132	12,000	6 (150)	3/16 (5)	1/4"	3/8 (10)	3 (85)	10.6 (268)	2.2 (1.0)	80
SM-65-5132A	12,000	5 (125)	3/16 (5)	1/4"	3/8 (10)	3 (85)	10.6 (268)	2.2 (1.0)	84
SM-66-5032A	12,000	6 (150)	3/8 (10)	1/4"	3/8 (10)	3 (85)	10.6 (268)	2.2 (1.0)	84
SM-66-5132A	12,000	6 (150)	3/16 (5)	1/4"	3/8 (10)	3 (85)	10.6 (268)	2.2 (1.0)	84

* Recommended Air Pressure at 90 PSI (6.2 Bar)

Random Orbital Palm Sanders

Features:

- Composite Motor Housing
- Orbit Diameter:
2.5 mm, 5 mm, 8 mm & 10 mm
- Well-balanced
- Low Vibration



▲ Operation of Palm Sander (Non-Vacuum)



EH-6133ASUB

Exhaust Hose Assembly (Optional)
(I.D. : 25.4mm ; O.D.: 33.4mm)



▲ Operation of Palm Sander (Central-Vacuum)



Non-Vacuum

SM-65-6033

5" Random Orbital Palm Sander
- Orbit Dia. 10 mm

SM-65-6833

5" Random Orbital Palm Sander
- Orbit Dia. 8 mm

SM-65-6133

5" Random Orbital Palm Sander
- Orbit Dia. 5 mm

SM-65-6233

5" Random Orbital Palm Sander
- Orbit Dia. 2.5 mm

SM-66-6033

6" Random Orbital Palm Sander
- Orbit Dia. 10 mm

SM-66-6833

6" Random Orbital Palm Sander
- Orbit Dia. 8 mm

SM-66-6133

6" Random Orbital Palm Sander
- Orbit Dia. 5 mm

SM-66-6233

6" Random Orbital Palm Sander
- Orbit Dia. 2.5 mm

Central-Vacuum

SM-65-6033C

5" Random Orbital Palm Sander
- Orbit Dia. 10 mm

SM-65-6833C

5" Random Orbital Palm Sander
- Orbit Dia. 8 mm

SM-65-6133C

5" Random Orbital Palm Sander
- Orbit Dia. 5 mm

SM-65-6233C

5" Random Orbital Palm Sander
- Orbit Dia. 2.5 mm

SM-66-6033C

6" Random Orbital Palm Sander
- Orbit Dia. 10 mm

SM-66-6833C

6" Random Orbital Palm Sander
- Orbit Dia. 8 mm

SM-66-6133C

6" Random Orbital Palm Sander
- Orbit Dia. 5 mm

SM-66-6233C

6" Random Orbital Palm Sander
- Orbit Dia. 2.5 mm

Random Orbital Palm Sanders

Self-Vacuum

SM-65-6033A

5" Random Orbital Palm Sander
- Orbit Dia. 10 mm

SM-65-6833A

5" Random Orbital Palm Sander
- Orbit Dia. 8 mm

SM-65-6133A

5" Random Orbital Palm Sander
- Orbit Dia. 5 mm

SM-65-6233A

5" Random Orbital Palm Sander
- Orbit Dia. 2.5 mm

SM-66-6033A

6" Random Orbital Palm Sander
- Orbit Dia. 10 mm

SM-66-6833A

6" Random Orbital Palm Sander
- Orbit Dia. 8 mm

SM-66-6133A

6" Random Orbital Palm Sander
- Orbit Dia. 5 mm

SM-66-6233A

6" Random Orbital Palm Sander
- Orbit Dia. 2.5 mm



Specifications:

Model No.	Max. Free Speed (RPM)	Orbit Diameter Inch (mm)	Pad Size Inch (mm)	Spindle Thread	Air Inlet (NPT)	Hose Size ID Inch (mm)	Air Consumption CFM (L/Min)	Length Inch (mm)	Weight Lbs (Kg)	Noise Level dB(A)
SM-65-6033	12,000	3/8 (10)	5 (125)	5/16"-24	1/4"	3/8 (10)	2 (57)	5.7 (146)	1.3 (0.6)	76
SM-65-6833	12,000	5/16 (8)	5 (125)	5/16"-24	1/4"	3/8 (10)	2 (57)	5.7 (146)	1.3 (0.6)	76
SM-65-6133	12,000	3/16 (5)	5 (125)	5/16"-24	1/4"	3/8 (10)	2 (57)	5.7 (146)	1.3 (0.6)	76
SM-65-6233	12,000	3/32 (2.5)	5 (125)	5/16"-24	1/4"	3/8 (10)	2 (57)	5.7 (146)	1.3 (0.6)	76
SM-66-6033	12,000	3/8 (10)	6 (150)	5/16"-24	1/4"	3/8 (10)	2 (57)	5.7 (146)	1.3 (0.6)	76
SM-66-6833	12,000	5/16 (8)	6 (150)	5/16"-24	1/4"	3/8 (10)	2 (57)	5.7 (146)	1.3 (0.6)	76
SM-66-6133	12,000	3/16 (5)	6 (150)	5/16"-24	1/4"	3/8 (10)	2 (57)	5.7 (146)	1.3 (0.6)	76
SM-66-6233	12,000	3/32 (2.5)	6 (150)	5/16"-24	1/4"	3/8 (10)	2 (57)	5.7 (146)	1.3 (0.6)	76
SM-65-6033C	12,000	3/8 (10)	5 (125)	5/16"-24	1/4"	3/8 (10)	2 (57)	7.4 (187)	1.5 (0.7)	76
SM-65-6833C	12,000	5/16 (8)	5 (125)	5/16"-24	1/4"	3/8 (10)	2 (57)	7.4 (187)	1.5 (0.7)	76
SM-65-6133C	12,000	3/16 (5)	5 (125)	5/16"-24	1/4"	3/8 (10)	2 (57)	7.4 (187)	1.5 (0.7)	76
SM-65-6233C	12,000	3/32 (2.5)	5 (125)	5/16"-24	1/4"	3/8 (10)	2 (57)	7.4 (187)	1.5 (0.7)	76
SM-66-6033C	12,000	3/8 (10)	6 (150)	5/16"-24	1/4"	3/8 (10)	2 (57)	7.4 (187)	1.5 (0.7)	76
SM-66-6833C	12,000	5/16 (8)	6 (150)	5/16"-24	1/4"	3/8 (10)	2 (57)	7.4 (187)	1.5 (0.7)	76
SM-66-6133C	12,000	3/16 (5)	6 (150)	5/16"-24	1/4"	3/8 (10)	2 (57)	7.4 (187)	1.5 (0.7)	76
SM-66-6233C	12,000	3/32 (2.5)	6 (150)	5/16"-24	1/4"	3/8 (10)	2 (57)	7.4 (187)	1.5 (0.7)	76
SM-65-6033A	12,000	3/8 (10)	5 (125)	5/16"-24	1/4"	3/8 (10)	2 (57)	7.4 (187)	1.5 (0.7)	84
SM-65-6833A	12,000	5/16 (8)	5 (125)	5/16"-24	1/4"	3/8 (10)	2 (57)	7.4 (187)	1.5 (0.7)	84
SM-65-6133A	12,000	3/16 (5)	5 (125)	5/16"-24	1/4"	3/8 (10)	2 (57)	7.4 (187)	1.5 (0.7)	84
SM-65-6233A	12,000	3/32 (2.5)	5 (125)	5/16"-24	1/4"	3/8 (10)	2 (57)	7.4 (187)	1.5 (0.7)	84
SM-66-6033A	12,000	3/8 (10)	6 (150)	5/16"-24	1/4"	3/8 (10)	2 (57)	7.4 (187)	1.5 (0.7)	84
SM-66-6833A	12,000	5/16 (8)	6 (150)	5/16"-24	1/4"	3/8 (10)	2 (57)	7.4 (187)	1.5 (0.7)	84
SM-66-6133A	12,000	3/16 (5)	6 (150)	5/16"-24	1/4"	3/8 (10)	2 (57)	7.4 (187)	1.5 (0.7)	84
SM-66-6233A	12,000	3/32 (2.5)	6 (150)	5/16"-24	1/4"	3/8 (10)	2 (57)	7.4 (187)	1.5 (0.7)	84

* Recommended Air Pressure at 90 PSI (6.2 Bar)

Random Orbital Oil-Free Palm Sanders

Features:

- Composite Motor Housing
- Orbit Diameter:
2.5 mm, 5 mm, 8 mm & 10 mm
- Well-balanced
- Low Vibration
- **Oil-Free**



▲ Operation of Palm Sander (Central-Vacuum)



▲ Operation of Palm Sander (Non-Vacuum)



Non-Vacuum

SM-65-5037

5" Random Orbital **Oil-Free** Palm Sander
- Orbit Dia. 10 mm

SM-65-5837

5" Random Orbital **Oil-Free** Palm Sander
- Orbit Dia. 8 mm

SM-65-5137

5" Random Orbital **Oil-Free** Palm Sander
- Orbit Dia. 5 mm

SM-65-5237

5" Random Orbital **Oil-Free** Palm Sander
- Orbit Dia. 2.5 mm

SM-66-5037

6" Random Orbital **Oil-Free** Palm Sander
- Orbit Dia. 10 mm

SM-66-5837

6" Random Orbital **Oil-Free** Palm Sander
- Orbit Dia. 8 mm

SM-66-5137

6" Random Orbital **Oil-Free** Palm Sander
- Orbit Dia. 5 mm

SM-66-5237

6" Random Orbital **Oil-Free** Palm Sander
- Orbit Dia. 2.5 mm

Central-Vacuum

SM-65-5037C

5" Random Orbital **Oil-Free** Palm Sander
- Orbit Dia. 10 mm

SM-65-5837C

5" Random Orbital **Oil-Free** Palm Sander
- Orbit Dia. 8 mm

SM-65-5137C

5" Random Orbital **Oil-Free** Palm Sander
- Orbit Dia. 5 mm

SM-65-5237C

5" Random Orbital **Oil-Free** Palm Sander
- Orbit Dia. 2.5 mm

SM-66-5037C

6" Random Orbital **Oil-Free** Palm Sander
- Orbit Dia. 10 mm

SM-66-5837C

6" Random Orbital **Oil-Free** Palm Sander
- Orbit Dia. 8 mm

SM-66-5137C

6" Random Orbital **Oil-Free** Palm Sander
- Orbit Dia. 5 mm

SM-66-5237C

6" Random Orbital **Oil-Free** Palm Sander
- Orbit Dia. 2.5 mm

Random Orbital Oil-Free Palm Sanders

Self-Vacuum

SM-65-5037A

5" Random Orbital **Oil-Free** Palm Sander
- Orbit Dia. 10 mm

SM-66-5037A

6" Random Orbital **Oil-Free** Palm Sander
- Orbit Dia. 10 mm

SM-65-5837A

5" Random Orbital **Oil-Free** Palm Sander
- Orbit Dia. 8 mm

SM-66-5837A

6" Random Orbital **Oil-Free** Palm Sander
- Orbit Dia. 8 mm

SM-65-5137A

5" Random Orbital **Oil-Free** Palm Sander
- Orbit Dia. 5 mm

SM-66-5137A

6" Random Orbital **Oil-Free** Palm Sander
- Orbit Dia. 5 mm

SM-65-5237A

5" Random Orbital **Oil-Free** Palm Sander
- Orbit Dia. 2.5 mm

SM-66-5237A

6" Random Orbital **Oil-Free** Palm Sander
- Orbit Dia. 2.5 mm



Specifications:

Model No.	Max. Free Speed (RPM)	Orbit Diameter Inch (mm)	Pad Size Inch (mm)	Spindle Thread	Air Inlet (NPT)	Hose Size ID Inch (mm)	Air Consumption CFM (L/Min)	Length Inch (mm)	Weight Lbs (Kg)	Noise Level dB(A)
SM-65-5037	12,000	3/8 (10)	5 (125)	5/16"-24	1/4"	3/8 (10)	2 (57)	5.7 (146)	1.3 (0.6)	76
SM-65-5837	12,000	5/16 (8)	5 (125)	5/16"-24	1/4"	3/8 (10)	2 (57)	5.7 (146)	1.3 (0.6)	76
SM-65-5137	12,000	3/16 (5)	5 (125)	5/16"-24	1/4"	3/8 (10)	2 (57)	5.7 (146)	1.3 (0.6)	76
SM-65-5237	12,000	3/32 (2.5)	5 (125)	5/16"-24	1/4"	3/8 (10)	2 (57)	5.7 (146)	1.3 (0.6)	76
SM-66-5037	12,000	3/8 (10)	6 (150)	5/16"-24	1/4"	3/8 (10)	2 (57)	5.7 (146)	1.3 (0.6)	76
SM-66-5837	12,000	5/16 (8)	6 (150)	5/16"-24	1/4"	3/8 (10)	2 (57)	5.7 (146)	1.3 (0.6)	76
SM-66-5137	12,000	3/16 (5)	6 (150)	5/16"-24	1/4"	3/8 (10)	2 (57)	5.7 (146)	1.3 (0.6)	76
SM-66-5237	12,000	3/32 (2.5)	6 (150)	5/16"-24	1/4"	3/8 (10)	2 (57)	5.7 (146)	1.3 (0.6)	76
SM-65-5037C	12,000	3/8 (10)	5 (125)	5/16"-24	1/4"	3/8 (10)	2 (57)	7.4 (187)	1.5 (0.7)	76
SM-65-5837C	12,000	5/16 (8)	5 (125)	5/16"-24	1/4"	3/8 (10)	2 (57)	7.4 (187)	1.5 (0.7)	76
SM-65-5137C	12,000	3/16 (5)	5 (125)	5/16"-24	1/4"	3/8 (10)	2 (57)	7.4 (187)	1.5 (0.7)	76
SM-65-5237C	12,000	3/32 (2.5)	5 (125)	5/16"-24	1/4"	3/8 (10)	2 (57)	7.4 (187)	1.5 (0.7)	76
SM-66-5037C	12,000	3/8 (10)	6 (150)	5/16"-24	1/4"	3/8 (10)	2 (57)	7.4 (187)	1.5 (0.7)	76
SM-66-5837C	12,000	5/16 (8)	6 (150)	5/16"-24	1/4"	3/8 (10)	2 (57)	7.4 (187)	1.5 (0.7)	76
SM-66-5137C	12,000	3/16 (5)	6 (150)	5/16"-24	1/4"	3/8 (10)	2 (57)	7.4 (187)	1.5 (0.7)	76
SM-66-5237C	12,000	3/32 (2.5)	6 (150)	5/16"-24	1/4"	3/8 (10)	2 (57)	7.4 (187)	1.5 (0.7)	76
SM-65-5037A	12,000	3/8 (10)	5 (125)	5/16"-24	1/4"	3/8 (10)	2 (57)	7.4 (187)	1.5 (0.7)	84
SM-65-5837A	12,000	5/16 (8)	5 (125)	5/16"-24	1/4"	3/8 (10)	2 (57)	7.4 (187)	1.5 (0.7)	84
SM-65-5137A	12,000	3/16 (5)	5 (125)	5/16"-24	1/4"	3/8 (10)	2 (57)	7.4 (187)	1.5 (0.7)	84
SM-65-5237A	12,000	3/32 (2.5)	5 (125)	5/16"-24	1/4"	3/8 (10)	2 (57)	7.4 (187)	1.5 (0.7)	84
SM-66-5037A	12,000	3/8 (10)	6 (150)	5/16"-24	1/4"	3/8 (10)	2 (57)	7.4 (187)	1.5 (0.7)	84
SM-66-5837A	12,000	5/16 (8)	6 (150)	5/16"-24	1/4"	3/8 (10)	2 (57)	7.4 (187)	1.5 (0.7)	84
SM-66-5137A	12,000	3/16 (5)	6 (150)	5/16"-24	1/4"	3/8 (10)	2 (57)	7.4 (187)	1.5 (0.7)	84
SM-66-5237A	12,000	3/32 (2.5)	6 (150)	5/16"-24	1/4"	3/8 (10)	2 (57)	7.4 (187)	1.5 (0.7)	84

* Recommended Air Pressure at 90 PSI (6.2 Bar)

Random Orbital Palm Sanders

Self-Vacuum

SM-65-6033B

5" Random Orbital Palm Sander
- Orbit Dia. 10 mm

SM-65-6833B

5" Random Orbital Palm Sander
- Orbit Dia. 8 mm

SM-65-6133B

5" Random Orbital Palm Sander
- Orbit Dia. 5 mm

SM-65-6233B

5" Random Orbital Palm Sander
- Orbit Dia. 2.5 mm

SM-66-6033B

6" Random Orbital Palm Sander
- Orbit Dia. 10 mm

SM-66-6833B

6" Random Orbital Palm Sander
- Orbit Dia. 8 mm

SM-66-6133B

6" Random Orbital Palm Sander
- Orbit Dia. 5 mm

SM-66-6233B

6" Random Orbital Palm Sander
- Orbit Dia. 2.5 mm



SM-65-5037B Oil-Free

5" Random Orbital Palm Sander
- Orbit Dia. 10 mm

SM-65-5837B Oil-Free

5" Random Orbital Palm Sander
- Orbit Dia. 8 mm

SM-65-5137B Oil-Free

5" Random Orbital Palm Sander
- Orbit Dia. 5 mm

SM-65-5237B Oil-Free

5" Random Orbital Palm Sander
- Orbit Dia. 2.5 mm

SM-66-5037B Oil-Free

6" Random Orbital Palm Sander
- Orbit Dia. 10 mm

SM-66-5837B Oil-Free

6" Random Orbital Palm Sander
- Orbit Dia. 8 mm

SM-66-5137B Oil-Free

6" Random Orbital Palm Sander
- Orbit Dia. 5 mm

SM-66-5237B Oil-Free

6" Random Orbital Palm Sander
- Orbit Dia. 2.5 mm



Specifications:

Model No.	Max. Free Speed (RPM)	Orbit Diameter Inch (mm)	Pad Size Inch (mm)	Spindle Thread	Air Inlet (NPT)	Hose Size ID Inch (mm)	Air Consumption CFM (L/Min)	Length Inch (mm)	Weight Lbs (Kg)	Noise Level dB(A)
SM-65-6033B	12,000	3/8 (10)	5 (125)	5/16"-24	1/4"	3/8 (10)	2 (57)	6.4 (162)	1.5 (0.7)	84
SM-65-6833B	12,000	5/16 (8)	5 (125)	5/16"-24	1/4"	3/8 (10)	2 (57)	6.4 (162)	1.5 (0.7)	84
SM-65-6133B	12,000	3/16 (5)	5 (125)	5/16"-24	1/4"	3/8 (10)	2 (57)	6.4 (162)	1.5 (0.7)	84
SM-65-6233B	12,000	3/32 (2.5)	5 (125)	5/16"-24	1/4"	3/8 (10)	2 (57)	6.4 (162)	1.5 (0.7)	84
SM-66-6033B	12,000	3/8 (10)	6 (150)	5/16"-24	1/4"	3/8 (10)	2 (57)	6.4 (162)	1.5 (0.7)	84
SM-66-6833B	12,000	5/16 (8)	6 (150)	5/16"-24	1/4"	3/8 (10)	2 (57)	6.4 (162)	1.5 (0.7)	84
SM-66-6133B	12,000	3/16 (5)	6 (150)	5/16"-24	1/4"	3/8 (10)	2 (57)	6.4 (162)	1.5 (0.7)	84
SM-66-6233B	12,000	3/32 (2.5)	6 (150)	5/16"-24	1/4"	3/8 (10)	2 (57)	6.4 (162)	1.5 (0.7)	84
SM-65-5037B	12,000	3/8 (10)	5 (125)	5/16"-24	1/4"	3/8 (10)	2 (57)	6.4 (162)	1.5 (0.7)	84
SM-65-5837B	12,000	5/16 (8)	5 (125)	5/16"-24	1/4"	3/8 (10)	2 (57)	6.4 (162)	1.5 (0.7)	84
SM-65-5137B	12,000	3/16 (5)	5 (125)	5/16"-24	1/4"	3/8 (10)	2 (57)	6.4 (162)	1.5 (0.7)	84
SM-65-5237B	12,000	3/32 (2.5)	5 (125)	5/16"-24	1/4"	3/8 (10)	2 (57)	6.4 (162)	1.5 (0.7)	84
SM-66-5037B	12,000	3/8 (10)	6 (150)	5/16"-24	1/4"	3/8 (10)	2 (57)	6.4 (162)	1.5 (0.7)	84
SM-66-5837B	12,000	5/16 (8)	6 (150)	5/16"-24	1/4"	3/8 (10)	2 (57)	6.4 (162)	1.5 (0.7)	84
SM-66-5137B	12,000	3/16 (5)	6 (150)	5/16"-24	1/4"	3/8 (10)	2 (57)	6.4 (162)	1.5 (0.7)	84
SM-66-5237B	12,000	3/32 (2.5)	6 (150)	5/16"-24	1/4"	3/8 (10)	2 (57)	6.4 (162)	1.5 (0.7)	84

* Recommended Air Pressure at 90 PSI (6.2 Bar)

5", 6" & 8" Gear-Driven Sanders / Polishers

Features:

- Low Speed, High Torque
- Central Vacuum System
- Random Orbital Fine Polishing & Sanding

SM-65-6238

5" Gear-Driven Sander/Polisher (900 RPM)
- Orbit Dia. 5 mm

SM-66-6238

6" Gear-Driven Sander/Polisher (900 RPM)
- Orbit Dia. 5 mm



Geared

SM-68-6238

8" Gear-Driven Sander/Polisher (900 RPM)
- Orbit Dia. 5 mm



Geared

SM-66-6238A

6" Gear-Driven Sander/Polisher (900 RPM)
- Orbit Dia. 5 mm



Geared

SM-68-6238A

8" Gear-Driven Sander/Polisher (900 RPM)
- Orbit Dia. 5 mm



Geared



EH-6238ASUB

Exhaust Hose Assembly (Optional)
(I.D. : 25.4 mm ; O.D.: 33.4 mm)

Accessories (Optional) :



#6P-663636-11 #80 Grit
Compounding Pad - Velcro



#6P-663637-11 #70 Grit
Compounding Pad - Velcro



#6N-663131V-6
#6N-663131V-8
Polishing Pad - Velcro



#66-6138A42
6" Sanding Pad



#68-6138A42
8" Sanding Pad



3M
Sanding Paper

▼ For SM-66-6238A Only

Specifications:

Model No.	Free Speed (RPM)	Pad Size Inch (mm)	Orbit Diameter Inch (mm)	Air Inlet (NPT)	Hose Size ID Inch (mm)	Air Consumption CFM (L/Min)	Length Inch (mm)	Weight Lbs (Kg)
SM-65-6238	900	5 (125)	3/16 (5)	1/4"	3/8 (10)	3.5 (99)	11.6 (295)	4.2 (1.9)
SM-66-6238	900	6 (152)	3/16 (5)	1/4"	3/8 (10)	3.5 (99)	11.6 (295)	4.2 (1.9)
SM-68-6238	900	8 (203)	3/16 (5)	1/4"	3/8 (10)	3.5 (99)	12.4 (315)	4.4 (2.0)
SM-66-6238A	900	6 (152)	3/16 (5)	1/4"	3/8 (10)	3.5 (99)	11 (280)	4.2 (1.9)
SM-68-6238A	900	8 (203)	3/16 (5)	1/4"	3/8 (10)	3.5 (99)	12.4 (315)	4.4 (2.0)

* Recommended Air Pressure at 90 PSI (6.2 Bar)

5" & 6" Vertical Sanders / Polishers

Features:

- Composite Motor Housing
- with Air Regulator
- 3,500 RPM
- Lightweight **1.1 Kg**
- **0.6 HP** Motor



Accessories (Optional) :

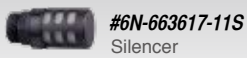

#6N-663617-11S
Silencer



#6N-663609-11
Silencer (Installed)



#6N-663636-11 #80 Grit
5" White Compounding Pad - Velcro



#6N-663637-11 #70 Grit
5" Yellow Compounding Pad - Velcro



#6N-663638-11
5" Wool Polishing Pad - Velcro

#6P-663636-11 #80 Grit
6" White Compounding Pad - Velcro

#6P-663637-11 #70 Grit
6" Yellow Compounding Pad - Velcro

#6N-666131V-6
6" Wool Polishing Pad - Velcro

SM-6N-6636

5" Vertical Sander/Polisher

SM-6P-6636

6" Vertical Sander/Polisher



SM-65-6636G

5" Vertical Sander/Polisher

SM-66-6636G

6" Vertical Sander/Polisher



Vacuum

Specifications:

Model No.	Free Speed (RPM)	Pad Size Inch (mm)	Spindle Thread	Air Inlet (NPT)	Hose Size ID Inch (mm)	Air Consumption CFM (L/Min)	Length (mm)	Weight Lbs (Kg)	Noise Level dB(A)
SM-6N-6636	3,500	5 (125)	5/16"-24	1/4"	3/8 (10)	3.9 (110)	144(H)x205(W)x214(L)	2.2 (1.0)	80
SM-6P-6636	3,500	6 (150)	5/16"-24	1/4"	3/8 (10)	3.9 (110)	144(H)x205(W)x214(L)	2.2 (1.0)	80
SM-65-6636G	3,500	5 (125)	5/16"-24	1/4"	3/8 (10)	3.9 (110)	134(H)x235(W)x220(L)	2.6 (1.2)	80
SM-66-6636G	3,500	6 (150)	5/16"-24	1/4"	3/8 (10)	3.9 (110)	134(H)x235(W)x220(L)	2.6 (1.2)	80

* Recommended Air Pressure at 90 PSI (6.2 Bar)

Vertical Polisher

Features:

- Safety Throttle Lever
- Side Handle

SM-6102

Vertical Polisher (3" & 6")



#52227
Spanner



#5D-619256
Standard Side Handle



#600627V-31
3" Sanding Pad



EH-522SUB
Exhaust Hose Assembly (Optional)



#610227V-61
6" Sanding Pad

Specifications:

Model No.	Free Speed (RPM)	Pad Size Inch (mm)	Spindle Thread	Air Inlet (NPT)	Hose Size ID Inch (mm)	Air Consumption CFM (L/Min)	Length Inch (mm)	Weight Lbs (Kg)
SM-6102	1,800	3 & 6 (75 & 150)	5/16"-24	1/4"	3/8 (10)	6 (170)	7.4 (187)	2.8 (1.3)

* Recommended Air Pressure at 90 PSI (6.2 Bar)

7" Vertical Sander / Polisher

Features:

- Built-in Comfort Grip
- **Low Noise 85 dB(A)**

SM-6203

7" Vertical Polisher

SM-6303

7" Vertical Sander / Polisher



Specifications:

Model No.	Free Speed (RPM)	Pad Size Inch (mm)	Spindle Thread	Air Inlet (NPT)	Hose Size ID Inch (mm)	Air Consumption CFM (L/Min)	Length Inch (mm)	Weight Lbs (Kg)	Noise Level dB(A)
SM-6203	2,000	7 (175)	5/8"-11	1/4"	3/8 (10)	11 (311)	7.4 (188)	4.8 (2.2)	85
SM-6303	5,000	7 (175)	5/8"-11	1/4"	3/8 (10)	11 (311)	7.4 (188)	4.8 (2.2)	85

* Recommended Air Pressure at 90 PSI (6.2 Bar)

Reversible High Speed Sanders

Features:

- **Composite Motor Housing**
(Double Injection only for SM-60-7253A)
- Reversing Bar on Both Sides
- Handle Exhaust
- **Patented Silencer 83 dB(A)**
- **0.6 HP**

Reversible



SM-60-7253A

5" Reversible High Speed Sander



SM-60-7254A

5" Reversible High Speed Sander

Features:

- **Built-in Comfort Grip**
- 3 Different Size of Pads
- Reversible
- Handle Exhaust
- **0.6 HP**



▲ Operation of Reversible High Speed Sander



SM-60-7251A

5" Reversible High Speed Sander



#66029
5-1/2" Pad

#66028
4-1/2" Pad

#66027
3" Pad

Specifications:

Model No.	Free Speed (RPM)	Pad Size (Inch)	Air Inlet (NPT)	Hose Size ID Inch (mm)	Air Consumption CFM (L/Min)	Length Inch (mm)	Weight Lbs (Kg)	Noise Level dB(A)
SM-60-7253A	16,000	3, 4-1/2, 5-1/2	1/4"	3/8 (10)	4 (113)	5.7 (146)	2.2 (1.0)	83
SM-60-7254A	16,000	3, 4-1/2, 5-1/2	1/4"	3/8 (10)	4 (113)	5.7 (146)	2.2 (1.0)	83
SM-60-7251A	16,000	3, 4-1/2, 5-1/2	1/4"	3/8 (10)	4 (113)	5.6 (142)	2.21 (1.0)	-

* Recommended Air Pressure at 90 PSI (6.2 Bar)

Mini Tool Series - Composite

Features:

- Composite Motor Housing
- Handle Exhaust
- **Low Noise 80 dB(A)**



Air Regulator



▲ Operation of Mini Polisher



SM-61-6321-2
2" Mini Disc Sander



SM-61-6321-3
3" Mini Disc Sander



SM-62-6321
1/4" Mini Die Grinder
- Collet Size : 1/4" (6 mm) or 1/8" (3 mm)



SM-63-6321-2
2" Mini Orbital Sander
- Orbit Dia. 4 mm
- Spindle : 1/4"-20 or M6x1.0



SM-63-6321-3
3" Mini Orbital Sander
- Orbit Dia. 4 mm
- Spindle : 1/4"-20 or M6x1.0



SM-64-6321
3" Mini Polisher
- Spindle : 1/4"-20 or M6x1.0

SM-66-6321
3" Mini Orbital Sander
- Orbit Dia. 4 mm
- Spindle : 5/16"-24

SM-68-6321
3" Mini Polisher
- Spindle : 5/16"-24

Specifications:

Model No.	Free Speed (RPM)	Pad Size Inch (mm)	Spindle Thread	Air Inlet (NPT)	Hose Size ID Inch (mm)	Air Consumption CFM (L/Min)	Length Inch (mm)	Weight Lbs (Kg)
SM-61-6321-2	15,000	2 (50)	1/4"-20	1/4"	3/8 (10)	3.5 (99)	3.9 (100)	1.19 (0.54)
SM-61-6321-3	15,000	3 (75)	1/4"-20	1/4"	3/8 (10)	3.5 (99)	3.9 (100)	1.19 (0.54)
SM-62-6321	20,000	-	-	1/4"	3/8 (10)	3.5 (99)	4.8 (121)	1.21 (0.55)
SM-63-6321-2	15,000	2 (50)	1/4"-20 or M6x1.0	1/4"	3/8 (10)	2.8 (79)	4.2 (107)	1.41 (0.64)
SM-63-6321-3	15,000	3 (75)	1/4"-20 or M6x1.0	1/4"	3/8 (10)	2.8 (79)	4.2 (107)	1.41 (0.64)
*SM-66-6321	15,000	3 (75)	5/16"-24	1/4"	3/8 (10)	2.8 (79)	4.2 (107)	1.41 (0.64)
SM-64-6321	3,200	3 (75)	1/4"-20 or M6x1.0	1/4"	3/8 (10)	3.2 (91)	4.6 (116)	1.59 (0.72)
*SM-68-6321	3,200	3 (75)	5/16"-24	1/4"	3/8 (10)	3.2 (91)	4.6 (116)	1.59 (0.72)

* Recommended Air Pressure at 90 PSI (6.2 Bar)

SM-61-6321K

Mini Disc Sander Kit (2" & 3")



Kit Includes:

In Blow Molded Case Complete with:

- | | | |
|--------|------------|---|
| 1 pc | SM-61-6321 | 2" & 3" Mini Disc Sander |
| 1 pc | #52227 | Spanner Wrench |
| 1 pc | SA-60012P | 2" Sanding Backup Pad |
| 10 pcs | SA-2060SD | #60 Grit Sanding Disc 2" Dia. |
| 10 pcs | SA-2080SD | #80 Grit Sanding Disc 2" Dia. |
| 10 pcs | SA-2120SD | #120 Grit Sanding Disc 2" Dia. |
| 3 pcs | SA-60012SP | 2" Surface Prep Pad (Fine, Medium & Coarse) |
| 1 pc | SA-60013P | 3" Sanding Backup Pad (Installed) |
| 10 pcs | SA-3060SD | #60 Grit Sanding Disc 3" Dia. |
| 10 pcs | SA-3080SD | #80 Grit Sanding Disc 3" Dia. |
| 10 pcs | SA-3120SD | #120 Grit Sanding Disc 3" Dia. |
| 3 pcs | SA-60013SP | 3" Surface Prep Pad (Fine, Medium & Coarse) |

SM-61-6321-2K

2" Mini Disc Sander Kit



Kit Includes:

In Blow Molded Case Complete with:

- | | | |
|--------|--------------|---|
| 1 pc | SM-61-6321-2 | 2" Mini Disc Sander |
| 1 pc | #52227 | Spanner Wrench |
| 1 pc | SA-60012P | 2" Sanding Backup Pad (Installed) |
| 10 pcs | SA-2060SD | #60 Grit Sanding Disc 2" Dia. |
| 10 pcs | SA-2080SD | #80 Grit Sanding Disc 2" Dia. |
| 10 pcs | SA-2120SD | #120 Grit Sanding Disc 2" Dia. |
| 3 pcs | SA-60012SP | 2" Surface Prep Pad (Fine, Medium & Coarse) |

Accessories:



SA-60012P
2" Sanding Backup Pad



SA-2060SD #60 Grit

Sanding Disc 2" Dia.

SA-2080SD #80 Grit

Sanding Disc 2" Dia.

SA-2100SD #100 Grit

Sanding Disc 2" Dia.

SA-2120SD #120 Grit

Sanding Disc 2" Dia.



SA-60012SP
2" Surface Prep Pad
(Fine, Medium & Coarse)

SM-61-6321-3K

3" Mini Disc Sander Kit



Kit includes:

In Blow Molded Case Complete with:

- | | | |
|--------|--------------|--|
| 1 pc | SM-61-6321-3 | 3" Mini Disc Sander |
| 1 pc | #52227 | Spanner Wrench |
| 1 pc | SA-60013P | 3" Sanding Backup Pad (Installed) |
| 10 pcs | SA-3060SD | #60 Grit Sanding Disc 3" Dia. |
| 10 pcs | SA-3080SD | #80 Grit Sanding Disc 3" Dia. |
| 10 pcs | SA-3120SD | #120 Grit Sanding Disc 3" Dia. |
| 3 pcs | SA-60013SP | 3" Surface Prep Pad
(Fine, Medium & Coarse) |

Accessories:



SA-60013P
3" Sanding Backup Pad



SA-3060SD #60 Grit

Sanding Disc 3" Dia.

SA-3080SD #80 Grit

Sanding Disc 3" Dia.

SA-3100SD #100 Grit

Sanding Disc 3" Dia.

SA-3120SD #120 Grit

Sanding Disc 3" Dia.



SA-60013SP
3" Surface Prep Pad
(Fine, Medium & Coarse)



SM-62-6321K

1/4" Mini Die Grinder Kit

Kit Includes:

In Blow Molded Case Complete with:

- 1 pc SM-62-6321 Mini Die Grinder
- 2 pcs #52227 Spanner Set
- 1 pc #51224-11 1/4" or 6 mm Collet (Installed)
- 1 pc #51224-12 1/8" or 3 mm Collet
- 10 pcs ST-512 Complete Set of Wheel Stones

SM-63-6321K

Mini Orbital Sander Kit (2" & 3")



Kit Includes:

In Blow Molded Case Complete with:

- 1 pc SM-63-6321 2" & 3" Mini Orbital Sander
- 1 pc #600324 Key Wrench
- 1 pc SA-6003V-2P 2" Velcro Sanding Pad
- 1 pc SA-6003V-3P 3" Velcro Sanding Pad (Installed)
- 10 pcs SA-2320GP 2" Sanding Paper #320 Grit
- 10 pcs SA-2400GP 2" Sanding Paper #400 Grit
- 10 pcs SA-2600GP 2" Sanding Paper #600 Grit
- 10 pcs SA-3320GP 3" Sanding Paper #320 Grit
- 10 pcs SA-3400GP 3" Sanding Paper #400 Grit
- 10 pcs SA-3600GP 3" Sanding Paper #600 Grit

Accessories:



SA-6003V-2P
2" Velcro Sanding Pad



SA-6003V-3P
3" Velcro Sanding Pad

SM-64-6321K

3" Mini Polisher Kit



Kit Includes:

In Blow Molded Case Complete with:

- 1 pc SM-64-6321 3" Mini Polisher
- 1 pc #51228 Key Wrench
- 1 pc SA-6003V-3P 3" Velcro Sanding Pad (Installed)
- 1 pc SA-77213 3-1/2" Bonnet
- 1 pc SA-75543VC 3-1/2" Yellow Compounding Pad
- 1 pc SA-75653VC 3-1/2" White Compounding Pad

Accessories:



SA-77213
3-1/2" Bonnet



SA-75543VC
3-1/2" Yellow Compounding Pad



SA-75653VC
3-1/2" White Compounding Pad

Features:

- Ergonomic Handle Design
- Built-in Comfort Grip
- Handle Exhaust



Air Regulator



SM-6001-2
2" Mini Disc Sander



SM-6001-3
3" Mini Disc Sander



SM-6002
1/4" Mini Die Grinder
- Collet Size : 1/4" (6 mm) or 1/8" (3 mm)



SM-6003V-2
2" Mini Orbital Sander
- Orbit Dia. 4 mm
- Spindle : 1/4"-20 or M6x1.0



SM-6003V-3
3" Mini Orbital Sander
- Orbit Dia. 4 mm
- Spindle : 1/4"-20 or M6x1.0



SM-6004
3" Mini Polisher
- Spindle : 1/4"-20 or M6x1.0

Rubber Grip Color:



SM-6006
3" Mini Orbital Sander
- Orbit Dia. 4 mm
- Spindle : 5/16"-24

SM-6008
3" Mini Polisher
- Spindle : 5/16"-24

Specifications:

Model No.	Free Speed (RPM)	Pad Size Inch (mm)	Spindle Thread	Air Inlet (NPT)	Hose Size ID Inch (mm)	Air Consumption CFM (L/Min)	Length Inch (mm)	Weight Lbs (Kg)	Noise Level dB(A)
SM-6001-2	15,000	2 (50)	1/4"-20	1/4"	3/8 (10)	3.2 (91)	3.9 (100)	1.3 (0.6)	84
SM-6001-3	15,000	3 (75)	1/4"-20	1/4"	3/8 (10)	3.2 (91)	3.9 (100)	1.3 (0.6)	84
SM-6002	15,000	-	-	1/4"	3/8 (10)	3.2 (91)	4.7 (120)	1.4 (0.65)	84
SM-6003V-2	15,000	2 (50)	1/4"-20 or M6x1.0	1/4"	3/8 (10)	3.2 (91)	4.2 (107)	1.5 (0.7)	84
SM-6003V-3	15,000	3 (75)	1/4"-20 or M6x1.0	1/4"	3/8 (10)	3.2 (91)	4.2 (107)	1.5 (0.7)	84
* SM-6006	15,000	3 (75)	5/16"-24	1/4"	3/8 (10)	3.2 (91)	4.2 (107)	1.5 (0.7)	84
SM-6004	2,500	3 (75)	1/4"-20 or M6x1.0	1/4"	3/8 (10)	3.2 (91)	4.5 (115)	1.8 (0.8)	84
* SM-6008	2,500	3 (75)	5/16"-24	1/4"	3/8 (10)	3.2 (91)	4.5 (115)	1.8 (0.8)	84

* Recommended Air Pressure at 90 PSI (6.2 Bar)

SM-6001K

Mini Disc Sander Kit (2" & 3")



Kit Includes:

In Blow Molded Case Complete with:

1 pc	SM-6001	Mini Disc Sander with Rubber Grip
1 pc	#52227	Spanner Wrench
1 pc	SA-60012P	2" Sanding Backup Pad (Installed)
10 pcs	SA-2060SD	#60 Grit Sanding Disc 2" Dia.
10 pcs	SA-2080SD	#80 Grit Sanding Disc 2" Dia.
10 pcs	SA-2120SD	#120 Grit Sanding Disc 2" Dia.
3 pcs	SA-60012SP	2" Surface Prep Pad (Fine, Medium & Coarse)
1 pc	SA-60013P	3" Sanding Backup Pad
10 pcs	SA-3060SD	#60 Grit Sanding Disc 3" Dia.
10 pcs	SA-3080SD	#80 Grit Sanding Disc 3" Dia.
10 pcs	SA-3120SD	#120 Grit Sanding Disc 3" Dia.
3 pcs	SA-60013SP	3" Surface Prep Pad (Fine, Medium & Coarse)

SM-6001-2K

2" Mini Disc Sander Kit



Kit Includes:

In Blow Molded Case Complete with:

1 pc	SM-6001-2	Mini Disc Sander with Rubber Grip
1 pc	#52227	Spanner Wrench
1 pc	SA-60012P	2" Sanding Backup Pad (Installed)
10 pcs	SA-2060SD	#60 Grit Sanding Disc 2" Dia.
10 pcs	SA-2080SD	#80 Grit Sanding Disc 2" Dia.
10 pcs	SA-2120SD	#120 Grit Sanding Disc 2" Dia.
3 pcs	SA-60012SP	2" Surface Prep Pad (Fine, Medium & Coarse)

Accessories:



SA-60012P
2" Sanding Backup Pad



SA-2060SD #60 Grit

Sanding Disc 2" Dia.

SA-2080SD #80 Grit

Sanding Disc 2" Dia.

SA-2100SD #100 Grit

Sanding Disc 2" Dia.

SA-2120SD #120 Grit

Sanding Disc 2" Dia.



SA-60012SP
2" Surface Prep Pad
(Fine, Medium & Coarse)

SM-6001-3K

3" Mini Disc Sander Kit

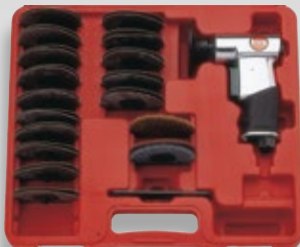

Kit Includes:

In Blow Molded Case Complete with:

1 pc	SM-6001-3	Mini Disc Sander with Rubber Grip
1 pc	#52227	Spanner Wrench
1 pc	SA-60013P	3" Sanding Backup Pad (Installed)
10 pcs	SA-3060SD	#60 Grit Sanding Disc 3" Dia.
10 pcs	SA-3080SD	#80 Grit Sanding Disc 3" Dia.
10 pcs	SA-3120SD	#120 Grit Sanding Disc 3" Dia.
3 pcs	SA-60013SP	3" Surface Prep Pad (Fine, Medium & Coarse)

Accessories:



SA-60013P
3" Sanding Backup Pad



SA-3060SD #60 Grit

Sanding Disc 3" Dia.

SA-3080SD #80 Grit

Sanding Disc 3" Dia.

SA-3100SD #100 Grit

Sanding Disc 3" Dia.

SA-3120SD #120 Grit

Sanding Disc 3" Dia.



SA-60013SP
3" Surface Prep Pad
(Fine, Medium & Coarse)



SM-6002K

1/4" Mini Die Grinder Kit

Kit Includes:

In Blow Molded Case Complete with:

- | | | |
|--------|-----------|-----------------------------------|
| 1 pc | SM-6002 | Mini Die Grinder with Rubber Grip |
| 2 pc | #52227 | Spanner Wrench |
| 10 pcs | ST-512 | Complete Set of Wheel Stones |
| 1 pc | #51224-11 | 1/4" or 6 mm Collet (Installed) |
| 1 pc | #51224-12 | 1/8" or 3 mm Collet |

SM-6003VK

Mini Orbital Sander Kit (2" & 3")



Kit Includes:

In Blow Molded Case Complete with:

- | | | |
|--------|-------------|--------------------------------------|
| 1 pc | SM-6003V | Mini Orbital Sander with Rubber Grip |
| 1 pc | #600324 | Key Wrench |
| 1 pc | SA-6003V-2P | 2" Velcro Sanding Pad |
| 1 pc | SA-6003V-3P | 3" Velcro Sanding Pad (Installed) |
| 10 pcs | SA-2320GP | 2" Sanding Paper #320 Grit |
| 10 pcs | SA-2400GP | 2" Sanding Paper #400 Grit |
| 10 pcs | SA-2600GP | 2" Sanding Paper #600 Grit |
| 10 pcs | SA-3320GP | 3" Sanding Paper #320 Grit |
| 10 pcs | SA-3400GP | 3" Sanding Paper #400 Grit |
| 10 pcs | SA-3600GP | 3" Sanding Paper #600 Grit |

Rubber Grip Color:



Accessories:



SA-6003V-2P
2" Velcro Sanding Pad



SA-6003V-3P
3" Velcro Sanding Pad

SM-6004K

3" Mini Polisher Kit



Kit Includes:

In Blow Molded Case Complete with:

- | | | |
|------|-------------|-----------------------------------|
| 1 pc | SM-6004 | 3" Mini Polisher with Rubber Grip |
| 1 pc | #51228 | Key Wrench |
| 1 pc | SA-6003V-3P | 3" Velcro Sanding Pad (Installed) |
| 1 pc | SA-77213 | 3-1/2" Bonnet |
| 1 pc | SA-75543VC | 3-1/2" Yellow Compounding Pad |
| 1 pc | SA-75653VC | 3-1/2" White Compounding Pad |

Rubber Grip Color:



Accessories:



SA-77213
3-1/2" Bonnet



SA-75543VC
3-1/2" Yellow Compounding Pad



SA-75653VC
3-1/2" White Compounding Pad

Features:

- Ergonomic Handle Design
- Variable Speed Trigger
- Built-in Comfort Grip
- Handle Exhaust

Rubber Grip Color:



SM-72833-2
2" Mini Orbital Sander
- Orbit Dia. 4 mm

SM-72833-3
3" Mini Orbital Sander
- Orbit Dia. 4 mm



SM-72831-2
2" Mini Disc Sander

SM-72831-3
3" Mini Disc Sander



SM-72832
1/4" Mini Die Grinder
- Collet Size : 1/4" (6 mm) or 1/8" (3 mm)



SM-72834
3" Mini Polisher



SM-72835
2" Mini Grinder

SM-72835K Includes:

2" Mini Grinder Kit in Box Complete with:

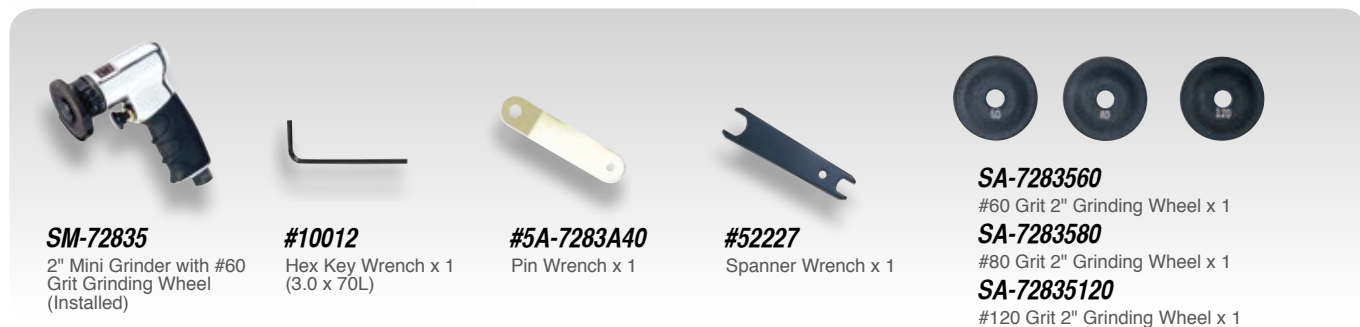

SM-72835
2" Mini Grinder with #60 Grit Grinding Wheel (Installed)

#10012
Hex Key Wrench x 1 (3.0 x 70L)

#5A-7283A40
Pin Wrench x 1

#52227
Spanner Wrench x 1

SA-7283560
#60 Grit 2" Grinding Wheel x 1
SA-7283580
#80 Grit 2" Grinding Wheel x 1
SA-72835120
#120 Grit 2" Grinding Wheel x 1

Specifications:

Model No.	Free Speed (RPM)	Pad / Disc Size Inch (mm)	Spindle Thread	Air Inlet (NPT)	Hose Size ID Inch (mm)	Air Consumption CFM (L/Min)	Length Inch (mm)	Weight Lbs (Kg)
SM-72831-2	15,000	2 (50)	1/4"-20	1/4"	3/8 (10)	4 (113)	4.3 (109)	1.5 (0.7)
SM-72831-3	15,000	3 (75)	1/4"-20	1/4"	3/8 (10)	4 (113)	4.3 (109)	1.5 (0.7)
SM-72832	18,000	-	-	1/4"	3/8 (10)	4 (113)	4.6 (117)	1.2 (0.54)
SM-72833-2	15,000	2 (50)	1/4"-20 or M6x1.0	1/4"	3/8 (10)	4 (113)	4.6 (117)	1.5 (0.7)
SM-72833-3	15,000	3 (75)	1/4"-20 or M6x1.0	1/4"	3/8 (10)	4 (113)	4.6 (117)	1.5 (0.7)
SM-72834	2,500	3 (75)	1/4"-20 or M6x1.0	1/4"	3/8 (10)	4 (113)	5.1 (130)	2 (0.9)
SM-72835	20,000	2 (50)	3/8"-24	1/4"	3/8 (10)	4 (113)	4 (102)	1.5 (0.7)

* Recommended Air Pressure at 90 PSI (6.2 Bar)

SM-72831K

Mini Disc Sander Kit (2" & 3")



Kit Includes:

In Blow Molded Case Complete with:

- | | | |
|--------|------------|---|
| 1 pc | SM-72831 | Mini Disc Sander with Rubber Grip |
| 1 pc | #52227 | Spanner Wrench |
| 1 pc | SA-60012P | 2" Sanding Backup Pad (Installed) |
| 10 pcs | SA-2060SD | #60 Grit Sanding Disc 2" Dia. |
| 10 pcs | SA-2080SD | #80 Grit Sanding Disc 2" Dia. |
| 10 pcs | SA-2120SD | #120 Grit Sanding Disc 2" Dia. |
| 3 pcs | SA-60012SP | 2" Surface Prep Pad (Fine, Medium & Coarse) |
| 1 pc | SA-60013P | 3" Sanding Backup Pad |
| 10 pcs | SA-3060SD | #60 Grit Sanding Disc 3" Dia. |
| 10 pcs | SA-3080SD | #80 Grit Sanding Disc 3" Dia. |
| 10 pcs | SA-3120SD | #120 Grit Sanding Disc 3" Dia. |
| 3 pcs | SA-60013SP | 3" Surface Prep Pad (Fine, Medium & Coarse) |

SM-72831-2K

2" Mini Disc Sander Kit



Kit Includes:

In Blow Molded Case Complete with:

- | | | |
|--------|------------|---|
| 1 pc | SM-72831-2 | Mini Disc Sander with Rubber Grip |
| 1 pc | #52227 | Spanner Wrench |
| 1 pc | SA-60012P | 2" Sanding Backup Pad (Installed) |
| 10 pcs | SA-2060SD | #60 Grit Sanding Disc 2" Dia. |
| 10 pcs | SA-2080SD | #80 Grit Sanding Disc 2" Dia. |
| 10 pcs | SA-2120SD | #120 Grit Sanding Disc 2" Dia. |
| 3 pcs | SA-60012SP | 2" Surface Prep Pad (Fine, Medium & Coarse) |

Accessories:



SA-60012P
2" Sanding Backup Pad



SA-2060SD #60 Grit
Sanding Disc 2" Dia.

SA-2080SD #80 Grit
Sanding Disc 2" Dia.

SA-2100SD #100 Grit
Sanding Disc 2" Dia.

SA-2120SD #120 Grit
Sanding Disc 2" Dia.



SA-60012SP
2" Surface Prep Pad
(Fine, Medium & Coarse)

SM-72831-3K

3" Mini Disc Sander Kit



Kit Includes:

In Blow Molded Case Complete with:

- | | | |
|--------|------------|---|
| 1 pc | SM-72831-3 | Mini Disc Sander with Rubber Grip |
| 1 pc | #52227 | Spanner Wrench |
| 1 pc | SA-60013P | 3" Sanding Backup Pad (Installed) |
| 10 pcs | SA-3060SD | #60 Grit Sanding Disc 3" Dia. |
| 10 pcs | SA-3080SD | #80 Grit Sanding Disc 3" Dia. |
| 10 pcs | SA-3120SD | #120 Grit Sanding Disc 3" Dia. |
| 3 pcs | SA-60013SP | 3" Surface Prep Pad (Fine, Medium & Coarse) |

Accessories:



SA-60013P
3" Sanding Backup Pad



SA-3060SD #60 Grit
Sanding Disc 3" Dia.

SA-3080SD #80 Grit
Sanding Disc 3" Dia.

SA-3100SD #100 Grit
Sanding Disc 3" Dia.

SA-3120SD #120 Grit
Sanding Disc 3" Dia.



SA-60013SP
3" Surface Prep Pad
(Fine, Medium & Coarse)

SM-72832K

Mini Die Grinder Kit



Kit Includes:

In Blow Molded Case Complete with:

1 pc	SM-72832	Mini Die Grinder with Rubber Grip
2 pc	#52227	Spanner Wrench
10 pcs	ST-512	Complete Set of Wheel Stones
1 pc	#51224-11	1/4" or 6 mm Collet (Installed)
1 pc	#51224-12	1/8" or 3 mm Collet

Rubber Grip Color:



SM-72833K

Mini Orbital Sander Kit (2" & 3")



Kit Includes:

In Blow Molded Case Complete with:

1 pc	SM-72833	Mini Orbital Sander with Rubber Grip
1 pc	#600324	Key Wrench
1 pc	SA-6003V-2P	2" Velcro Sanding Pad
1 pc	SA-6003V-3P	3" Velcro Sanding Pad (Installed)
10 pcs	SA-2320GP	2" Sanding Paper #320 Grit
10 pcs	SA-2400GP	2" Sanding Paper #400 Grit
10 pcs	SA-2600GP	2" Sanding Paper #600 Grit
10 pcs	SA-3320GP	3" Sanding Paper #320 Grit
10 pcs	SA-3400GP	3" Sanding Paper #400 Grit
10 pcs	SA-3600GP	3" Sanding Paper #600 Grit

Rubber Grip Color:



Accessories:



SA-6003V-2P
2" Velcro Sanding Pad



SA-6003V-3P
3" Velcro Sanding Pad



SM-72834K

3" Mini Polisher Kit

Kit Includes:

In Blow Molded Case Complete with:

1 pc	SM-72834	3" Mini Polisher with Rubber Grip
1 pc	#51228	Key Wrench
1 pc	SA-6003V-3P	3" Velcro Sanding Pad (Installed)
1 pc	SA-77213	3-1/2" Bonnet
1 pc	SA-75543VC	3-1/2" Yellow Compounding Pad
1 pc	SA-75653VC	3-1/2" White Compounding Pad

Rubber Grip Color:



Accessories:



SA-77213
3-1/2" Bonnet



SA-75543VC
3-1/2" Yellow
Compounding
Pad



SA-75653VC
3-1/2" White
Compounding
Pad

Finger Sanders

Features:

- Ergonomic Handle Design
- Built-in Comfort Grip
- Handle Exhaust
- with Regulator

SM-6C30

Finger Sander
- Orbit Dia. 3 mm



SM-6C31

Finger Sander
- Orbit Dia. 3 mm



Specifications:

Model No.	Blows Per Min. (BPM)	Pad Size Inch (mm)	Air Inlet (NPT)	Hose Size ID Inch (mm)	Air Consumption CFM (L/Min)	Length Inch (mm)	Weight Lbs (Kg)
SM-6C30	11,000	1-1/2 x 3-3/8 (40 x 86)	1/4"	3/8 (10)	3.5 (99)	7.5 (190)	2 (0.9)
SM-6C31	11,000	1-1/8 (28.5)	1/4"	3/8 (10)	3.5 (99)	7.5 (190)	2 (0.9)

* Recommended Air Pressure at 90 PSI (6.2 Bar)

Air Trimmer

SM-205

Air Trimmer



Specifications:

Model No.	Free Speed (RPM)	Air Inlet (NPT)	Hose Size ID Inch (mm)	Air Consumption CFM (L/Min)	Length Inch (mm)	Weight Lbs (Kg)
SM-205	20,000	1/4"	1/4 (6)	4 (113)	9 (229)	0.8 (0.4)

* Recommended Air Pressure at 90 PSI (6.2 Bar)



Belt Sanders

Features:

- Comfort Grip
- Safety Lever
- Silencer
- Swivel Connector Air Inlet



SM-6W-6060
6mm Belt Sander



SM-6W-6100
10mm Belt Sander - 10 mm x 330 mm

SM-6W-6102
13mm Belt Sander - 13 mm x 330 mm



SM-6W-6120
13mm Belt Sander - 13 mm x 610 mm



SM-6T-6200
20mm Belt Sander



SM-620SG
20mm Belt Sander



SM-6X-6300
30mm Belt Sander

Specifications:

Model No.	Free Speed (RPM)	Belt Size Inch (mm)	Air Inlet (NPT)	Hose Size ID Inch (mm)	Air Consumption CFM (L/Min)	Folded Length Inch (mm)	Max. Length Inch (mm)	Weight Lbs (Kg)	Noise Level dB(A)
SM-6W-6060	20,000	1/4 x 13 (6 x 330)	1/4"	3/8 (10)	4.2 (119)	8.1 (207)	13 (331)	1.8 (0.85)	84
SM-6W-6100	20,000	3/8 x 13 (10 x 330)	1/4"	3/8 (10)	4.2 (119)	8.1 (207)	13 (331)	1.8 (0.85)	84
SM-6W-6102	20,000	1/2 x 13 (13 x 330)	1/4"	3/8 (10)	4.2 (119)	8.1 (207)	13 (331)	1.8 (0.85)	84
SM-6W-6120	20,000	1/2 x 24 (13 x 610)	1/4"	3/8 (10)	4.2 (119)	12.2 (310)	18.2 (463)	2 (0.95)	84
SM-620SG	18,000	3/4 x 20-1/2 (20 x 520)	1/4"	3/8 (10)	4.2 (119)	9.8 (250)	16.1 (410)	3.3 (1.5)	84
SM-6T-6200	18,000	3/4 x 20-1/2 (20 x 520)	1/4"	3/8 (10)	4.2 (119)	10 (255)	16 (407)	3.5 (1.6)	84
SM-6X-6300	12,000	1-5/32 x 21-1/4 (30 x 540)	1/4"	3/8 (10)	4.2 (119)	10 (255)	16.5 (420)	5.0 (2.3)	84

* Recommended Air Pressure at 90 PSI (6.2 Bar)

Belt Sanders & Kit



SM-6W-6203

10mm Belt Sander - 10 mm x 330 mm



SM-6T-6202

20mm Belt Sander - 20 mm x 520 mm

Features:

- 4 pcs Interchangeable Contact Arms
- Kit Contents Both Normal Abrasive Belt and Surface Prep Belt
- Sanding **Track Adjustable**
- Safety Cover
- Comfort Grip
- Swivel Air Inlet
- **0.5 HP**

SM-6Z-6103K

Belt Sander Kit



SM-6Z-6103

Belt Sander



Surface Prep Belts



Part No.
6U-6103PB15

Surface Prep Belt (coarse)
13mm x 12", #150 grit



Part No.
6U-6103PB30

Surface Prep Belt (fine)
13mm x 12", #300 grit

Normal Abrasive Belts



Part No.
6U-6103060 (3 pcs)

13mm x 12", #60 grit
6U-6103080 (3 pcs)
13mm x 12", #80 grit

6U-6103120 (3 pcs)

13mm x 12", #120 grit

6X-6103060 (1 pc)

6mm x 12", #60 grit

6X-6103080 (1 pc)

6mm x 12", #80 grit

6X-6103120 (1 pc)

6mm x 12", #120 grit

Contact Arms



Part No.
6U-610341

Belt Size : 1/2" x 12"
(13 mm x 305 mm)



Part No.
6V-610341

Belt Size : 1/4" or 1/2" x 12"
(6 mm or 13 mm x 305 mm)



Part No.
6Y-610341

Belt Size : 1/2" x 12"
(13 mm x 305 mm)



Part No.
6X-610341

Belt Size : 1/4" x 12"
(6 mm x 305 mm)

Specifications:

Model No.	Free Speed (RPM)	Belt Size Inch (mm)	Air Inlet (NPT)	Hose Size ID Inch (mm)	Air Consumption CFM (L/Min)	Length Inch (mm)	Weight Lbs (Kg)
SM-6W-6203	20,000	3/8 x 13 (10 x 330)	1/4"	3/8 (10)	3.9 (110)	12 (305)	2.0 (0.9)
SM-6T-6202	18,000	3/4 x 20-1/2 (20 x 520)	1/4"	3/8 (10)	4.2 (119)	14.8 (376)	3.3 (1.5)
SM-6Z-6103	20,000	1/4 or 1/2 x 12 (6 or 13 x 305)	1/4"	3/8 (10)	3.9 (110)	11.4 (289)	2.2 (1.0)

* Recommended Air Pressure at 90 PSI (6.2 Bar)

Features:

- 4 Interchangeable Contact Arms
- Use Both Normal Abrasive Belt and Surface Prep Belt
- Comfort Grip
- Silencer For Lower Noise
- Swivel Air Inlet

SM-6Z-6104K

Belt Sander Kit



SM-6Z-6104

Belt Sander



Contact Arms



Part No.
6U-610341
Belt Size : 1/2" x 12"
(13 mm x 305 mm)



Part No.
6V-610341
Belt Size : 1/4" or 1/2" x 12"
(6 mm or 13 mm x 305 mm)



Part No.
6Y-610341
Belt Size : 1/2" x 12"
(13 mm x 305 mm)



Part No.
6X-610341
Belt Size : 1/4" x 12"
(6 mm x 305 mm)

Surface Prep Belts



Part No.
6U-6103PB15
Surface Prep Belt (coarse)
13mm x 12", #150 grit



Part No.
6U-6103PB30
Surface Prep Belt (fine)
13mm x 12", #300 grit

Normal Abrasive Belts



Part No.
6U-6103060 (3 pcs)
13mm x 12", #60 grit
6U-6103080 (3 pcs)
13mm x 12", #80 grit

6U-6103120 (3 pcs)
13mm x 12", #120 grit

6X-6103060 (1 pc)
6mm x 12", #60 grit

6X-6103080 (1 pc)
6mm x 12", #80 grit

6X-6103120 (1 pc)
6mm x 12", #120 grit

Specifications:

Model No.	Free Speed (RPM)	Belt Size Inch (mm)	Air Inlet (NPT)	Hose Size ID Inch (mm)	Air Consumption CFM (L/Min)	Length Inch (mm)	Weight Lbs (Kg)	Noise Level dB(A)
SM-6Z-6104	20,000	1/4 or 1/2 x 12 (6 or 13 x 305)	1/4"	3/8 (10)	4.2 (119)	12.3 (313)	2.2 (1.0)	84

* Recommended Air Pressure at 90 PSI (6.2 Bar)

Features:

- 6 Interchangeable Contact Arms
- Use Both Normal Abrasive Belt and Surface Prep Belt
- Dead Handle For Easy Operation
- Comfort Grip
- Silencer For Lower Noise
- Swivel Air Inlet

SM-6Z-6201

Belt Sander



SM-6Z-6201K

Belt Sander Kit



Sanding on Curve Surface



Surface Prep Belts



Normal Abrasive Belts



Part No.

SA-6S060AB

25mm x 18", #60 grit

SA-6S080AB

25mm x 18", #80 grit

SA-6T060AB

20mm x 18", #60 grit

SA-6T080AB

20mm x 18", #80 grit

SA-6U080AB

13mm x 18", #80 grit

SA-6U120AB

13mm x 18", #120 grit

SA-6V120AB

10mm x 18", #120 grit

SA-6V150AB

10mm x 18", #150 grit

SA-6X150AB

6mm x 18", #150 grit

Optional!

Optional!

Contact Arms



Part No.

SA-6S6201

Belt Size : 1" x 18"
(25 mm x 457 mm)

Optional!



Part No.

SA-6T6201

Belt Size : 5/8" or 3/4" x 18"
(16 mm or 20 mm x 457 mm)



Part No.

SA-6U6201

Belt Size : 3/4" x 18"
(20 mm x 457 mm)

Surface Prep Belts



Part No.

SA-6T080PB

Surface Prep Belt (coarse)
20mm x 18", #80 grit



Part No.

SA-6V6201

Belt Size : 1/8", 1/4", 3/8" or 1/2" x 18"
(3, 6, 10 or 13 x 457 mm)



Part No.

SA-6W6201

Belt Size : 1/2" x 18"
(13 mm x 457 mm)



Part No.

SA-6X6201

Belt Size : 1/4" x 18"
(6 mm x 457 mm)



Part No.

SA-6U300PB

Surface Prep Belt (fine)
13mm x 18", #300 grit

Specifications:

Model No.	Free Speed (RPM)	Belt Size Inch (mm)	Air Inlet (NPT)	Hose Size ID Inch (mm)	Air Consumption CFM (L/Min)	Length Inch (mm)	Weight Lbs (Kg)	Noise Level dB(A)
SM-6Z-6201	18,000	1/4 ~ 1 (6 ~ 25)	1/4"	3/8 (10)	4.5 (119)	15.4 (390)	3.1 (1.4)	84

* Recommended Air Pressure at 90 PSI (6.2 Bar)

Versatility Belt Sander

Features:

- Quick and Easy Belt Change
- Belt Tracking Permits Use of 1/4" or 1/2" Wide x 24" Long Abrasive Belts
- Lightweight Composite Belt Guard
- Composite Motor Housing



SM-6Z-6105

Versatility Belt Sander



Specifications:

Model No.	Free Speed (RPM)	Belt Size Inch (mm)	Air Inlet (NPT)	Hose Size ID Inch (mm)	Air Consumption CFM (L/Min)	Length Inch (mm)	Weight Lbs (Kg)
SM-6Z-6105	20,000	1/4 & 1/2 (6 & 13) W x 24 (610) L	1/4"	3/8 (10)	4.2 (119)	15.7 (400)	3 (1.36)

* Recommended Air Pressure at 90 PSI (6.2 Bar)

Auto Shut-Off Screwdrivers & Angle Nutrunners

Features:

- **Oil Free** Air Motor
- **1,000,000** Cycles Life Time
- Power of The Motor : **150** Watt

SM-EP-0205T

Auto Shut-Off Screwdriver (150 RPM)

SM-EP-0705T

Auto Shut-Off Screwdriver (650 RPM)

SM-EP-1005T

Auto Shut-Off Screwdriver (950 RPM)

SM-EP-1404T

Auto Shut-Off Screwdriver (1,400 RPM)



SM-EL-0207L

Auto Shut-Off Angle Nutrunner (150 RPM)
- Lever Start

SM-EL-0705L

Auto Shut-Off Angle Nutrunner (650 RPM)
- Lever Start

SM-EL-1004L

Auto Shut-Off Angle Nutrunner (950 RPM)
- Lever Start

SM-EL-1403L

Auto Shut-Off Angle Nutrunner (1,400 RPM)
- Lever Start



Specifications:

Model No.	Free Speed (RPM)	Air Inlet (NPT)	Torque Range In-lbs (Nm)	Air Consumption CFM (L/Min)	Length Inch (mm)	Weight Lbs (Kg)	Noise Level dB(A)
SM-EP-0205T	150	1/4"	3.5~44.3 (0.4~5)	1.8 (51)	7.5 (191)	1.79 (0.81)	71
SM-EP-0705T	650	1/4"	3.5~44.3 (0.4~5)	1.8 (51)	7 (178)	1.59 (0.72)	71
SM-EP-1005T	950	1/4"	3.5~39.8 (0.4~4.5)	1.8 (51)	7 (178)	1.59 (0.72)	71
SM-EP-1404T	1,400	1/4"	3.5~31 (0.4~3.5)	1.8 (51)	7 (178)	1.59 (0.72)	71
SM-EL-0207L	150	1/4"	7.1~44.3 (0.8~5)	1.6 (46)	11.3 (288)	1.65 (0.75)	73
SM-EL-0705L	650	1/4"	7.1~44.3 (0.8~5)	1.6 (46)	10.9 (276)	1.54 (0.7)	73
SM-EL-1004L	950	1/4"	7.1~35.4 (0.8~4)	1.6 (46)	10.9 (276)	1.54 (0.7)	73
SM-EL-1403L	1,400	1/4"	7.1~26.6 (0.8~3)	1.6 (46)	10.9 (276)	1.54 (0.7)	73

* Recommended Air Pressure at 90 PSI (6.2 Bar)

Features:

- **Oil Free** Air Motor
- **1,000,000** Cycles Life Time
- Power of The Motor : **150** Watt

SM-ES-0205L

Auto Shut-Off Screwdriver (150 RPM)
- Lever Start

SM-ES-0705L

Auto Shut-Off Screwdriver (650 RPM)
- Lever Start

SM-ES-1005L

Auto Shut-Off Screwdriver (950 RPM)
- Lever Start

SM-ES-1404L

Auto Shut-Off Screwdriver (1,400 RPM)
- Lever Start



SM-ES-0205P

Auto Shut-Off Screwdriver (150 RPM)
- Push Start

SM-ES-0705P

Auto Shut-Off Screwdriver (650 RPM)
- Push Start

SM-ES-1005P

Auto Shut-Off Screwdriver (950 RPM)
- Push Start

SM-ES-1404P

Auto Shut-Off Screwdriver (1,400 RPM)
- Push Start



Specifications:

Model No.	Free Speed (RPM)	Air Inlet (NPT)	Torque Range In-lbs (Nm)	Air Consumption CFM (L/Min)	Length Inch (mm)	Weight Lbs (Kg)	Noise Level dB(A)
SM-ES-0205L	150	1/4"	3.5~44.3 (0.4~5)	1.6 (46)	9.4 (240)	1.34 (0.61)	73
SM-ES-0705L	650	1/4"	3.5~44.3 (0.4~5)	1.6 (46)	9 (228)	1.32 (0.6)	73
SM-ES-1005L	950	1/4"	3.5~39.8 (0.4~4.5)	1.6 (46)	9 (228)	1.32 (0.6)	73
SM-ES-1404L	1,400	1/4"	3.5~31 (0.4~3.5)	1.6 (46)	9 (228)	1.32 (0.6)	73
SM-ES-0205P	150	1/4"	3.5~44.3 (0.4~5)	1.6 (46)	9.5 (241)	1.48 (0.67)	73
SM-ES-0705P	650	1/4"	3.5~44.3 (0.4~5)	1.6 (46)	9 (229)	1.3 (0.59)	73
SM-ES-1005P	950	1/4"	3.5~39.8 (0.4~4.5)	1.6 (46)	9 (229)	1.3 (0.59)	73
SM-ES-1404P	1,400	1/4"	3.5~31 (0.4~3.5)	1.6 (46)	9 (229)	1.3 (0.59)	73

* Recommended Air Pressure at 90 PSI (6.2 Bar)

Features:

- **Oil-Free** Air Motor
- **1,000,000** Cycles Life Time
- Power of The Motor : **260** Watt

SM-BP-0412T

Auto Shut-Off Screwdriver (400 RPM)

SM-BP-0810T

Auto Shut-Off Screwdriver (800 RPM)

SM-BP-1008T

Auto Shut-Off Screwdriver (1,000 RPM)

SM-BP-1305T

Auto Shut-Off Screwdriver (1,300 RPM)

SM-BP-2004T

Auto Shut-Off Screwdriver (2,000 RPM)



Specifications:

Model No.	Free Speed (RPM)	Air Inlet (NPT)	Torque Range In-lbs (Nm)	Air Consumption CFM (L/Min)	Length Inch (mm)	Weight Lbs (Kg)	Noise Level dB(A)
SM-BP-0412T	400	1/4"	31~106.2 (3.5~12)	2.1 (59)	8.3 (210)	2.3 (1.1)	73
SM-BP-0810T	800	1/4"	31~84.1 (3.5~9.5)	2.1 (59)	8.3 (210)	2.3 (1.1)	73
SM-BP-1008T	1,000	1/4"	31~70.8 (3.5~8)	2.1 (59)	8.3 (210)	2.3 (1.1)	73
SM-BP-1305T	1,300	1/4"	3.5~44.3 (0.4~5)	2.1 (59)	7.7 (195)	2.1 (1)	73
SM-BP-2004T	2,000	1/4"	3.5~35.4 (0.4~4)	2.1 (59)	7.7 (195)	2.1 (1)	73

* Recommended Air Pressure at 90 PSI (6.2 Bar)

Auto Shut-Off Screwdrivers & Angle Nutrunners

Features:

- **Oil-Free** Air Motor
- **1,000,000** Cycles Life Time
- Power of The Motor : **260** Watt

SM-BS-0412L

Auto Shut-Off Screwdriver (400 RPM)
- Lever Start

SM-BS-1008L

Auto Shut-Off Screwdriver (1,000 RPM)
- Lever Start

SM-BS-2004L

Auto Shut-Off Screwdriver (2,000 RPM)
- Lever Start

SM-BS-0810L

Auto Shut-Off Screwdriver (850 RPM)
- Lever Start

SM-BS-1405L

Auto Shut-Off Screwdriver (1,350 RPM)
- Lever Start

Lever Start



SM-BS-0412P

Auto Shut-Off Screwdriver (400 RPM)
- Push Start

SM-BS-1008P

Auto Shut-Off Screwdriver (1,000 RPM)
- Push Start

SM-BS-2004P

Auto Shut-Off Screwdriver (2,000 RPM)
- Push Start

SM-BS-0810P

Auto Shut-Off Screwdriver (850 RPM)
- Push Start

SM-BS-1405P

Auto Shut-Off Screwdriver (1,350 RPM)
- Push Start

Push Start

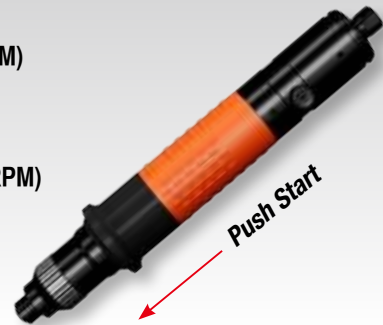

SM-CL-0426L

Auto Shut-Off Angle Nutrunner (350 RPM)
- Lever Start



Specifications:

Model No.	Free Speed (RPM)	Air Inlet (NPT)	Torque Range In-lbs (Nm)	Air Consumption CFM (L/Min)	Length Inch (mm)	Weight Lbs (Kg)	Noise Level dB(A)
SM-BS-0412L	400	1/4"	31~106.2 (3.5~12)	1.8 (51)	10.7 (271)	2.05 (0.93)	75
SM-BS-0810L	850	1/4"	31~84.1 (3.5~9.5)	1.8 (51)	10.7 (271)	2.05 (0.93)	75
SM-BS-1008L	1,000	1/4"	31~70.8 (3.5~8)	1.8 (51)	10.7 (271)	2.05 (0.93)	75
SM-BS-1405L	1,350	1/4"	3.5~44.3 (0.4~5)	1.8 (51)	9.9 (251)	1.87 (0.85)	75
SM-BS-2004L	2,000	1/4"	3.5~35.4 (0.4~4)	1.8 (51)	9.9 (251)	1.87 (0.85)	75
SM-BS-0412P	400	1/4"	31~106.2 (3.5~12)	1.8 (51)	10.7 (272)	2 (0.9)	75
SM-BS-0810P	850	1/4"	31~84.1 (3.5~9.5)	1.8 (51)	10.7 (272)	2 (0.9)	75
SM-BS-1008P	1,000	1/4"	31~70.8 (3.5~8)	1.8 (51)	10.7 (272)	2 (0.9)	75
SM-BS-1405P	1,350	1/4"	3.5~44.3 (0.4~5)	1.8 (51)	9.9 (252)	1.8 (0.8)	75
SM-BS-2004P	2,000	1/4"	3.5~35.4 (0.4~4)	1.8 (51)	9.9 (252)	1.8 (0.8)	75
SM-CL-0426L	350	1/4"	101.8~230.1 (11.5~26)	3 (85)	13 (331)	3.19 (1.45)	75

* Recommended Air Pressure at 90 PSI (6.2 Bar)

Auto Shut-Off Screwdrivers

Features:

- Pistol Version with Air On Top
- with 2 Extra Springs for Different Torque
- Reversible
- Rear Exhaust
- Built-in Cushion Grip
- **Low Noise 83 dB(A)**



▲ Operation of Auto Shut-Off Screwdriver



▲ Operation of Auto Shut-Off Screwdriver



Air On Top



Adjustable Torque

SM-AS004

Auto Shut-off Screwdriver (600 RPM)

SM-AS104

Auto Shut-off Screwdriver (1,000 RPM)

SM-AS204

Auto Shut-off Screwdriver (1,800 RPM)

SM-AS304

Auto Shut-off Screwdriver (2,300 RPM)



Torque Springs			
Spring Color	Torque Range		tensionCode Number
	In-lbs	Nm	
Yellow	10~38	1.1~4.3	AS000149-11
Black	5~19	0.6~2.1	AS000149-12
Green	2~8	0.23~0.9	AS000149-13

Accessories (Optional):



AS000149-11SUB

Cam Assembly
Torque Range : 10~38 In-lbs



AS000149-12SUB

Cam Assembly
Torque Range : 5~19 In-lbs



AS000149-13SUB

Cam Assembly
Torque Range : 2~8 In-lbs



AS000149-11

Strong Spring (ø 3.5 mm)
(Good for SM-AS004, SM-AS104)



AS000149-12

Medium Spring (ø 2.8 mm)
(Good for SM-AS204)

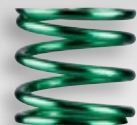

AS000149-13

Light Spring (ø 2.0 mm)

▼ Adjusting springs of three different tensions are available for adjustment of torque

Specifications:

Model No.	Free Speed (RPM)	Torque Range In-lbs (Nm)	Air Inlet (NPT)	Hose Size ID Inch (mm)	Air Consumption CFM (L/Min)	Length Inch (mm)	Weight Lbs (Kg)	Noise Level dB(A)
SM-AS004	600	4~45 (0.5~5.1)	1/4"	3/8 (10)	4 (113)	8.9 (225)	2.0 (0.9)	83
SM-AS104	1,000	3~40 (0.3~4.5)	1/4"	3/8 (10)	4 (113)	8.5 (216)	2.0 (0.9)	83
SM-AS204	1,800	3~26 (0.3~2.9)	1/4"	3/8 (10)	4 (113)	8.7 (220)	2.0 (0.9)	83
SM-AS304	2,300	3~26 (0.3~2.9)	1/4"	3/8 (10)	4 (113)	8.5 (215)	2.0 (0.9)	83

* Recommended Air Pressure at 90 PSI (6.2 Bar)

Auto Shut-Off Screwdrivers

Features:

- with 2 Extra Springs for Different Torque
- Built-in Cushion Grip
- Reversible
- Rear Exhaust
- **Low Noise 83 dB(A)**

Accessories (Optional):



AS000149-11SUB

Cam Assembly
Torque Range : 10~38 In-lbs



AS000149-12SUB

Cam Assembly
Torque Range : 5~19 In-lbs



AS000149-13SUB

Cam Assembly
Torque Range : 2~8 In-lbs



AS000149-11

Strong Spring (ø 3.5 mm)
(Good for SM-AS004, SM-AS104)



AS000149-11

Medium Spring (ø 2.8 mm)
(Good for SM-AS204)

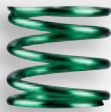

AS000149-13

Light Spring (ø 2.0 mm)

SM-AS002 / SM-AS102 / SM-AS202

Auto Shut-off Screwdriver (600 / 1,000 / 1,800 RPM)



SM-AS002A / SM-AS102A / SM-AS202A

Auto Shut-off Screwdriver (600 / 1,000 / 1,800 RPM)



SM-AS005 / SM-AS105 / SM-AS205 / SM-AS305

Auto Shut-off Screwdriver (650 / 1,100 / 1,800 / 2,300 RPM)



Specifications:

Model No.	Free Speed (RPM)	Torque Range In-lbs (Nm)	Air Inlet (NPT)	Hose Size ID Inch (mm)	Air Consumption CFM (L/Min)	Length Inch (mm)	Weight Lbs (Kg)	Noise Level dB(A)
SM-AS002 / SM-AS002A	600	4~45 (0.5~5.1)	1/4"	3/8 (10)	4 (113)	8.7 (222)	1.98 (0.9)	83
SM-AS102 / SM-AS102A	1,000	3~40 (0.3~4.5)	1/4"	3/8 (10)	4 (113)	8.3 (212)	1.98 (0.9)	83
SM-AS202 / SM-AS202A	1,800	3~26 (0.3~2.9)	1/4"	3/8 (10)	4 (113)	8.6 (218)	1.98 (0.9)	83
SM-AS005	650	4~45 (0.5~5.1)	1/4"	3/8 (10)	4 (113)	9.3 (237)	1.54 (0.7)	83
SM-AS105	1,100	3~40 (0.3~4.5)	1/4"	3/8 (10)	4 (113)	8.9 (227)	1.54 (0.7)	83
SM-AS205	1,800	3~26 (0.3~2.9)	1/4"	3/8 (10)	4 (113)	9.1 (232)	1.54 (0.7)	83
SM-AS305	2,500	3~26 (0.3~2.9)	1/4"	3/8 (10)	4 (113)	8.9 (227)	1.54 (0.7)	83

* Recommended Air Pressure at 90 PSI (6.2 Bar)

1/4" Air Screwdrivers

Features:

- Ergonomic Handle Design
- **Variable Speed Trigger**
- **Forward and Reverse Control on Top**
- Built-in Comfort Grip
- Rotating Air Inlet
- Handle Exhaust

SM-88-7251

1/4" Air Screwdriver (1,800 RPM)
- Direct Drive



SM-89-7251

1/4" Air Screwdriver (800 RPM)
- Direct Drive



Features:

- Ergonomic Handle Design
- **Variable Speed Trigger**
- **Built-in Comfort Grip**
- Forward and Reverse Control Bar
- Handle Exhaust

SM-88-8225

1/4" Air Screwdriver (1,800 RPM)
- Direct Drive



SM-89-8225

1/4" Air Screwdriver (800 RPM)
- Direct Drive



SM-88-8020

1/4" Air Screwdriver (1,800 RPM)
- Direct Drive



SM-89-8020

1/4" Air Screwdriver (800 RPM)
- Direct Drive



Specifications:

Model No.	Free Speed (RPM)	Hex Drive Capacity (Inch)	Air Inlet (NPT)	Hose Size ID Inch (mm)	Air Consumption CFM (L/Min)	Length Inch (mm)	Weight Lbs (Kg)
SM-88-7251	1,800	1/4	1/4"	3/8 (10)	4 (113)	7.2 (182)	2.4 (1.1)
SM-89-7251	800	1/4	1/4"	3/8 (10)	4 (113)	7.9 (200)	2.9 (1.3)
SM-88-8225	1,800	1/4	1/4"	3/8 (10)	4 (113)	6.8 (172)	2.4 (1.1)
SM-89-8225	800	1/4	1/4"	3/8 (10)	4 (113)	7.9 (200)	2.9 (1.3)
SM-88-8020	1,800	1/4	1/4"	3/8 (10)	4 (113)	7.1 (180)	2.2 (1)
SM-89-8020	800	1/4	1/4"	3/8 (10)	4 (113)	8 (202)	2.6 (1.2)

* Recommended Air Pressure at 90 PSI (6.2 Bar)

1/4" Air Screwdrivers

Features:

- **Composite Motor Housing Double Injection**
- Planetary Gear System with Needle Bearings (Option)
- Reversing Bar on the Both Sides
- **Two Speed Trigger**
(Slow speed when pulled halfway)
- **Patented Silencer 83 dB(A)**
- **0.5 HP**

SM-88-7253P

1/4" Air Screwdriver (1,800 RPM)
- Direct Drive



SM-89-7253P

1/4" Air Screwdriver (800 RPM)
- Direct Drive



Features:

- **Composite Motor Housing**
- Planetary Gear System with Needle Bearings (Option)
- Reversing Bar on the Both Sides
- **Two Speed Trigger**
(Slow speed when pulled halfway)
- **Patented Silencer 83 dB(A)**
- **0.5 HP**

SM-88-7254P

1/4" Air Screwdriver (1,800 RPM)
- Direct Drive



SM-89-7254P

1/4" Air Screwdriver (800 RPM)
- Direct Drive



Specifications:

Model No.	Free Speed (RPM)	Hex Drive Capacity (Inch)	Torque In-lbs (Nm)	Air Inlet (NPT)	Hose Size ID Inch (mm)	Air Consumption CFM (L/Min)	Length Inch (mm)	Weight Lbs (Kg)	Noise Level dB(A)
SM-88-7253P	1,800	1/4	52 (6)	1/4"	3/8 (10)	4 (113)	7.2 (182)	2.4 (1.1)	83
SM-89-7253P	800	1/4	130 (15)	1/4"	3/8 (10)	4 (113)	7.9 (200)	2.8 (1.3)	83
SM-88-7254P	1,800	1/4	52 (6)	1/4"	3/8 (10)	4 (113)	7.2 (182)	2.4 (1.1)	83
SM-89-7254P	800	1/4	130 (15)	1/4"	3/8 (10)	4 (113)	7.9 (200)	2.8 (1.3)	83

* Recommended Air Pressure at 90 PSI (6.2 Bar)

1/4" Industrial Air Screwdrivers

Features:

- **External Adjustable**
- **Forward: Adjustable Torque**
Reverse: Full Torque
- Planetary Gear System with Needle Bearings (Option)
- Variable Speed Trigger
- Muffler in Handle

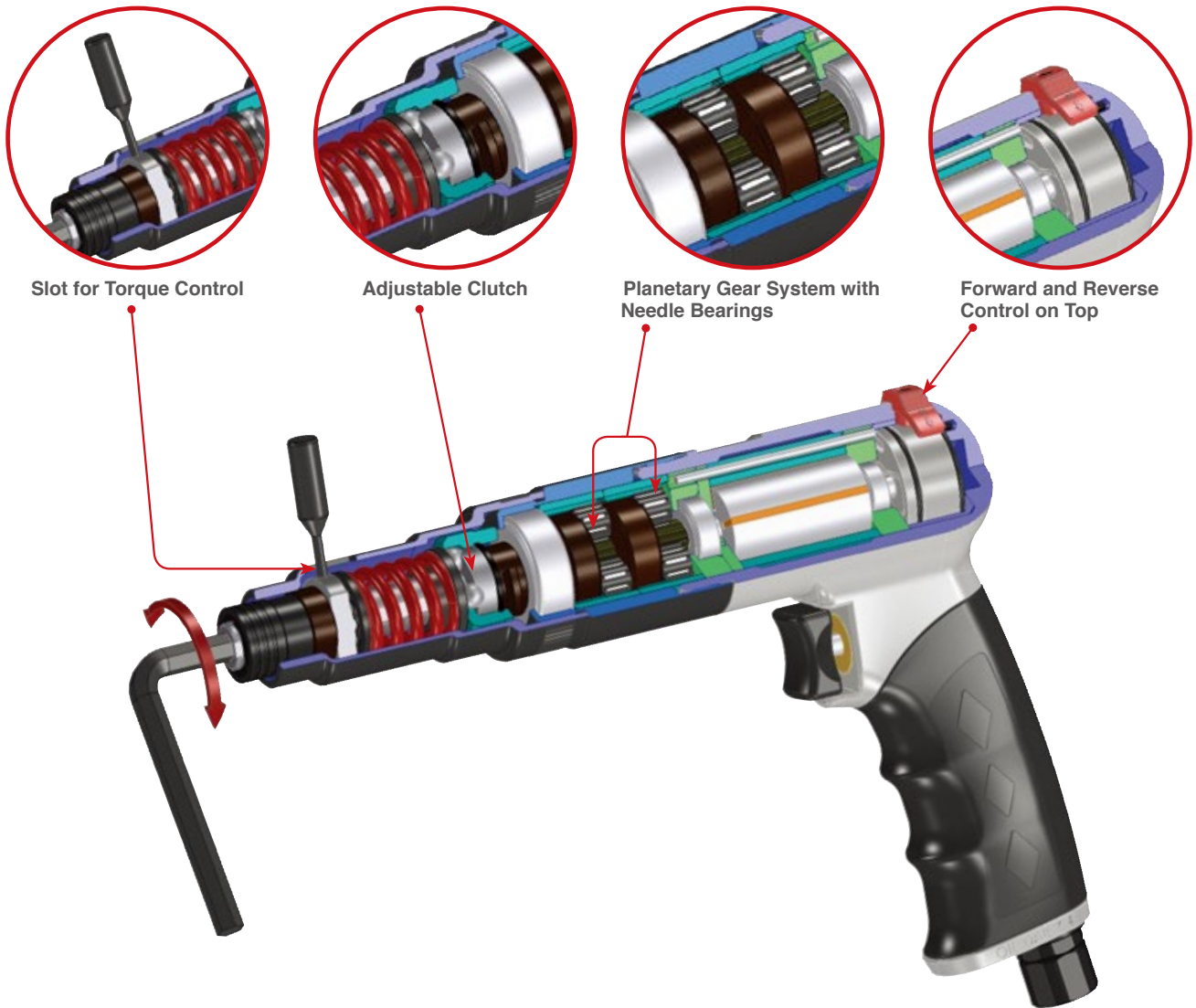
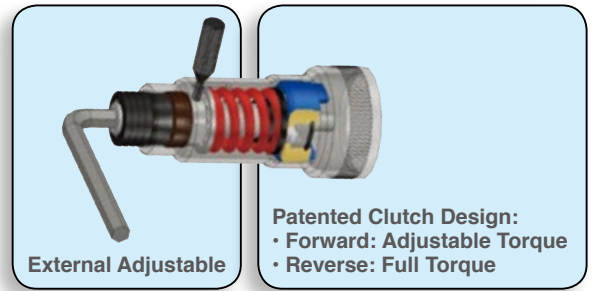

1/4" Industrial Air Screwdrivers

Quiet Series

Features:

- **Cushion Clutch with External Clutch Adjustment**
- **Forward : Adjustable Torque**
Reverse : Full Torque
- **Composite Motor Housing**
- **Low Noise 83 dB(A)**
- Planetary Gear System with Needle Bearings (Option)
- Reversing Bar on Both Sides
- Two Speed Trigger (Slow speed when pulled halfway)
- **0.5 HP**

SM-82-7253P

1/4" Air Screwdriver (1,800 RPM)
- Adjustable Clutch



SM-83-7253P

1/4" Air Screwdriver (800 RPM)
- Adjustable Clutch



SM-84-7253P

1/4" Air Screwdriver (1,800 RPM)
- Positive Clutch



SM-86-7253P

1/4" Air Screwdriver (800 RPM)
- Positive Clutch



SM-82-7253PF

1/4" Air Screwdriver (1,800 RPM)
- External Adjustable Clutch



▲ External Adjustable

SM-83-7253PF

1/4" Air Screwdriver (800 RPM)
- External Adjustable Clutch



▲ External Adjustable

Specifications:

Model No.	Free Speed (RPM)	Hex Drive Capacity (Inch)	Torque In-lbs (Nm)	Air Inlet (NPT)	Hose Size ID Inch (mm)	Air Consumption CFM (L/Min)	Length Inch (mm)	Weight Lbs (Kg)	Noise Level dB(A)
SM-82-7253P	1,800	1/4	30~70 (3~8)	1/4"	3/8 (10)	4 (113)	8.2 (208)	2.2 (1.0)	83
SM-83-7253P	800	1/4	30~95 (3~11)	1/4"	3/8 (10)	4 (113)	9 (228)	2.6 (1.2)	83
SM-84-7253P	1,800	1/4	115 (13)	1/4"	3/8 (10)	4 (113)	7.7 (196)	2.2 (1.0)	83
SM-86-7253P	800	1/4	145 (16)	1/4"	3/8 (10)	4 (113)	7.9 (200)	2.4 (1.1)	83
SM-82-7253PF	1,800	1/4	20~50 (2~6)	1/4"	3/8 (10)	4 (113)	8.2 (208)	2.2 (1.0)	83
SM-83-7253PF	800	1/4	45~80 (5~9)	1/4"	3/8 (10)	4 (113)	9 (228)	2.6 (1.2)	83

* Recommended Air Pressure at 90 PSI (6.2 Bar)

1/4" Industrial Air Screwdrivers

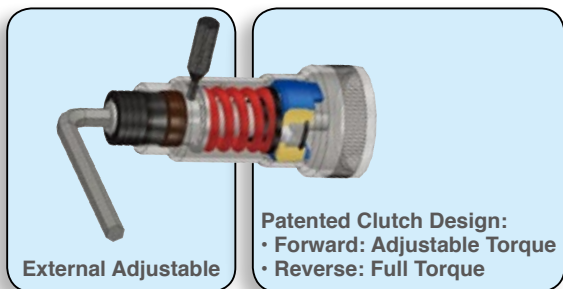

#802F37-11

Red Spring (ø 3.2 mm)
Torque Range : 20~50 In-lbs



#802F37-12

Blue Spring (ø 3.5 mm)
Torque Range : 40~85 In-lbs

▲ Adjusting springs of 2 different tensions are available for external adjustment of torque.

SM-82-7254P

1/4" Air Screwdriver (1,800 RPM)
- Adjustable Clutch



SM-83-7254P

1/4" Air Screwdriver (800 RPM)
- Adjustable Clutch



SM-84-7254P

1/4" Air Screwdriver (1,800 RPM)
- Positive Clutch



SM-86-7254P

1/4" Air Screwdriver (800 RPM)
- Positive Clutch



SM-82-7254PF

1/4" Air Screwdriver (1,800 RPM)
- External Adjustable Clutch



▲ External Adjustable

SM-83-7254PF

1/4" Air Screwdriver (800 RPM)
- External Adjustable Clutch



▲ External Adjustable

Specifications:

Model No.	Free Speed (RPM)	Hex Drive Capacity (Inch)	Torque In-lbs (Nm)	Air Inlet (NPT)	Hose Size ID Inch (mm)	Air Consumption CFM (L/Min)	Length Inch (mm)	Weight Lbs (Kg)	Noise Level dB(A)
SM-82-7254P	1,800	1/4	30~70 (3~8)	1/4"	3/8 (10)	4 (113)	8.2 (208)	2.2 (1.0)	83
SM-83-7254P	800	1/4	30~95 (3~11)	1/4"	3/8 (10)	4 (113)	9 (228)	2.6 (1.2)	83
SM-84-7254P	1,800	1/4	115 (13)	1/4"	3/8 (10)	4 (113)	7.7 (196)	2.2 (1.0)	83
SM-86-7254P	800	1/4	145 (16)	1/4"	3/8 (10)	4 (113)	7.9 (200)	2.4 (1.1)	83
SM-82-7254PF	1,800	1/4	20~50 (2~6)	1/4"	3/8 (10)	4 (113)	7.7 (196)	2.2 (1.0)	83
SM-83-7254PF	800	1/4	40~85 (5~9)	1/4"	3/8 (10)	4 (113)	8.4 (214)	2.6 (1.2)	83

* Recommended Air Pressure at 90 PSI (6.2 Bar)

1/4" Industrial Air Screwdrivers

Features:

- **Ergonomic Handle Design**
- **Variable Speed Trigger**
- Planetary Gear System with Needle Bearings (Option)
- Built-in Comfort Grip
- Forward and Reverse Control on Top & Painted in Red
- Rotating Air Inlet
- Handle Exhaust
- **Low Noise 83 dB(A)**

Quiet Series



SM-82-7251
1/4" Air Screwdriver (1,800 RPM)
- Adjustable Clutch



SM-83-7251
1/4" Air Screwdriver (800 RPM)
- Adjustable Clutch



SM-84-7251
1/4" Air Screwdriver (1,800 RPM)
- Positive Clutch



SM-86-7251
1/4" Air Screwdriver (800 RPM)
- Positive Clutch

Specifications:

Model No.	Free Speed (RPM)	Hex Drive Capacity (Inch)	Torque In-lbs (Nm)	Air Inlet (NPT)	Hose Size ID Inch (mm)	Air Consumption CFM (L/Min)	Length Inch (mm)	Weight Lbs (Kg)	Noise Level dB(A)
SM-82-7251	1,800	1/4	30~70 (3~8)	1/4"	3/8 (10)	4 (113)	7.7 (196)	2.9 (1.3)	83
SM-83-7251	800	1/4	30~95 (3~11)	1/4"	3/8 (10)	4 (113)	8.4 (214)	3.1 (1.4)	83
SM-84-7251	1,800	1/4	115 (13)	1/4"	3/8 (10)	4 (113)	7.2 (182)	2.6 (1.2)	83
SM-86-7251	800	1/4	145 (16)	1/4"	3/8 (10)	4 (113)	7.4 (188)	3.5 (1.6)	83

* Recommended Air Pressure at 90 PSI (6.2 Bar)

1/4" Industrial Air Screwdrivers

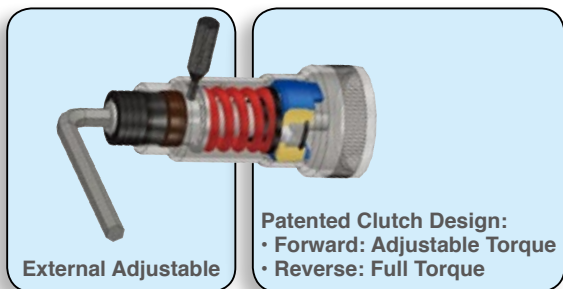

#802F37-11
Red Spring (ø 3.2 mm)
Torque Range : 20~50 In-lbs



#802F37-12
Blue Spring (ø 3.5 mm)
Torque Range : 40~85 In-lbs

▲ Adjusting springs of 2 different tensions are available for external adjustment of torque.

SM-82-7251F

1/4" Air Screwdriver (1,800 RPM)
- External Adjustable Clutch



▲ External Adjustable



SM-83-7251F

1/4" Air Screwdriver (800 RPM)
- External Adjustable Clutch



▲ External Adjustable



SM-80-7251

1/4" Air Screwdriver (1,800 RPM)
- External Adjustable Clutch



▲ External Adjustable



SM-85-7251

1/4" Air Screwdriver (800 RPM)
- External Adjustable Clutch



▲ External Adjustable



SM-81-7251

1/4" Air Screwdriver (1,800 RPM)
- External Adjustable Clutch



▲ External Adjustable



SM-87-7251

1/4" Air Screwdriver (800 RPM)
- External Adjustable Clutch

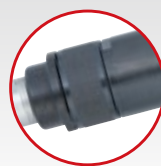

▲ External Adjustable



Specifications:

Model No.	Free Speed (RPM)	Hex Drive Capacity (Inch)	Torque In-lbs (Nm)	Air Inlet (NPT)	Hose Size ID Inch (mm)	Air Consumption CFM (L/Min)	Length Inch (mm)	Weight Lbs (Kg)	Noise Level dB(A)
SM-82-7251F	1,800	1/4	20~50 (2~6)	1/4"	3/8 (10)	4 (113)	7.7 (196)	2.9 (1.3)	83
SM-83-7251F	800	1/4	40~85 (5~10)	1/4"	3/8 (10)	4 (113)	8.4 (214)	3.1 (1.4)	83
SM-80-7251	1,800	1/4	20~62 (2~7)	1/4"	3/8 (10)	4 (113)	8.8 (224)	3.3 (1.5)	83
SM-85-7251	800	1/4	20~100 (2~11)	1/4"	3/8 (10)	4 (113)	9.5 (242)	3.5 (1.6)	83
SM-81-7251	1,800	1/4	26~71 (3~8)	1/4"	3/8 (10)	4 (113)	7.7 (196)	3.2 (1.45)	83
SM-87-7251	800	1/4	44~100 (5~11)	1/4"	3/8 (10)	4 (113)	8.4 (214)	3.5 (1.6)	83

* Recommended Air Pressure at 90 PSI (6.2 Bar)

1/4" Industrial Air Screwdrivers

Features:

- **Ergonomic Handle Design**
- **Variable Speed Trigger**
- Planetary Gear System with Needle Bearings (Option)
- Built-in Comfort Grip
- Handle Exhaust
- **Low Noise 83 dB(A)**



SM-8225
1/4" Air Screwdriver (1,800 RPM)
- Adjustable Clutch



SM-8235
1/4" Air Screwdriver (800 RPM)
- Adjustable Clutch



SM-8245
1/4" Air Screwdriver (1,800 RPM)
- Positive Clutch



SM-8265
1/4" Air Screwdriver (800 RPM)
- Positive Clutch

Specifications:

Model No.	Free Speed (RPM)	Hex Drive Capacity (Inch)	Torque In-lbs (Nm)	Air Inlet (NPT)	Hose Size ID Inch (mm)	Air Consumption CFM (L/Min)	Length Inch (mm)	Weight Lbs (Kg)	Noise Level dB(A)
SM-8225	1,800	1/4	30~70 (3~8)	1/4"	3/8 (10)	4 (113)	7.8 (197)	2.6 (1.2)	83
SM-8235	800	1/4	30~95 (3~11)	1/4"	3/8 (10)	4 (113)	8.5 (216)	3 (1.4)	83
SM-8245	1,800	1/4	115 (13)	1/4"	3/8 (10)	4 (113)	7.2 (184)	2.8 (1.3)	83
SM-8265	800	1/4	145 (16)	1/4"	3/8 (10)	4 (113)	7.8 (197)	2.8 (1.3)	83

* Recommended Air Pressure at 90 PSI (6.2 Bar)

1/4" Industrial Air Screwdrivers

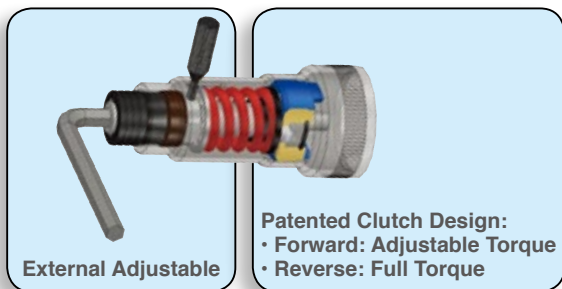

#802F37-11

Red Spring (ø 3.2 mm)
Torque Range : 20~50 In-lbs



#802F37-12

Blue Spring (ø 3.5 mm)
Torque Range : 40~85 In-lbs

▲ Adjusting springs of 2 different tensions are available for external adjustment of torque.



Specifications:

Model No.	Free Speed (RPM)	Hex Drive Capacity (Inch)	Torque In-lbs (Nm)	Air Inlet (NPT)	Hose Size ID Inch (mm)	Air Consumption CFM (L/Min)	Length Inch (mm)	Weight Lbs (Kg)	Noise Level dB(A)
SM-8225F	1,800	1/4	20~50 (2~6)	1/4"	3/8 (10)	4 (113)	7.7 (196)	2.9 (1.3)	83
SM-8235F	800	1/4	40~85 (5~10)	1/4"	3/8 (10)	4 (113)	8.4 (214)	3 (1.4)	83
SM-9825	1,800	1/4	20~62 (2~7)	1/4"	3/8 (10)	4 (113)	8.7 (222)	3.3 (1.5)	83
SM-9835	800	1/4	20~100 (2~11)	1/4"	3/8 (10)	4 (113)	9.5 (241)	3.5 (1.6)	83

* Recommended Air Pressure at 90 PSI (6.2 Bar)

1/4" Industrial Air Screwdrivers

Features:

- **External Adjustable Clutch**
- **Forward: Adjustable Torque**
Reverse: Full Torque
- Planetary Gear System with Needle Bearings (Option)
- **Low Noise 85 dB(A)**
(SM-82-8423F & SM-83-8423F)

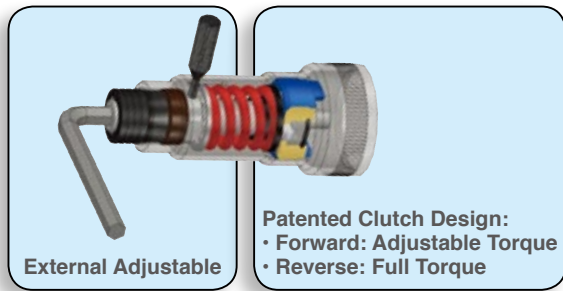

#802F37-11

Red Spring (ø 3.2 mm)
Torque Range : 20~50 In-lbs



#802F37-12

Blue Spring (ø 3.5 mm)
Torque Range : 40~85 In-lbs

▲ Adjusting springs of 2 different tensions are available for external adjustment of torque.



SM-842F

1/4" Straight Air Screwdriver (1,800 RPM)
- External Adjustable Clutch

▲ External Adjustable



SM-843F

1/4" Straight Air Screwdriver (800 RPM)
- External Adjustable Clutch

▲ External Adjustable



SM-82-8423F

1/4" Straight Air Screwdriver (1,800 RPM)
- External Adjustable Clutch

▲ External Adjustable



SM-83-8423F

1/4" Straight Air Screwdriver (800 RPM)
- External Adjustable Clutch

▲ External Adjustable

Specifications:

Model No.	Free Speed (RPM)	Hex Drive Capacity (Inch)	Torque In-lbs (Nm)	Air Inlet (NPT)	Hose Size ID Inch (mm)	Air Consumption CFM (L/Min)	Length Inch (mm)	Weight Lbs (Kg)	Noise Level dB(A)
SM-842F	1,800	1/4	20~50 (2~6)	1/4"	3/8 (10)	4 (113)	9.6 (244)	2.4 (1.1)	90
SM-843F	800	1/4	40~85 (5~10)	1/4"	3/8 (10)	4 (113)	10.2 (260)	2.6 (1.2)	90
SM-82-8423F	1,800	1/4	20~50 (2~6)	1/4"	3/8 (10)	4 (113)	10.0 (254)	2.6 (1.2)	85
SM-83-8423F	800	1/4	40~85 (5~10)	1/4"	3/8 (10)	4 (113)	10.7 (272)	3 (1.4)	85

* Recommended Air Pressure at 90 PSI (6.2 Bar)

Composite Housing Series



NEW

Impact Wrenches, Impact Driver, Screwdrivers

Features:

- **Composite Motor Housing**
- Handle Exhaust

SM-40-7500
1/4" Mini Impact Wrench



SM-41-7500
3/8" Mini Impact Wrench



SM-48-7500
1/4" Impact Driver



Patent No.

US D727,706 S
TW D159601 M510220
Patent Pending in Multi-Countries

Specifications:

Model No.	Free Speed (RPM)	Anvil (or Chuck) Size Inch (mm)	Maximum Torque Ft-lbs (Nm)	Working Torque Range Ft-lbs (Nm)	Air Inlet (NPT)	Hose Size ID Inch (mm)	Average Air Consumption CFM (L/Min)	Length Inch (mm)	Weight Lbs (Kg)
SM-40-7500	12,000	1/4 (6)	75 (102)	25~70 (34-95)	1/4"	3/8 (10)	4 (113)	6.7 (170)	2.2 (1.0)
SM-41-7500	12,000	3/8 (10)	100 (136)	25~90 (34~122)	1/4"	3/8 (10)	4 (113)	6.9 (174)	2.2 (1.0)
SM-48-7500	12,000	1/4 (Hex)	75 (102)	25~40 (34~54)	1/4"	3/8 (10)	4 (113)	7.1 (181)	2.2 (1.0)

* Recommended Air Pressure at 90 PSI (6.2 Bar)

Features:

- **Composite Motor Housing**
- Planetary Gear System with Needle Bearings (Option)
- **Variable Speed Trigger**
- **0.5 HP**

SM-88-7500
1/4" Air Screwdriver (1,800 RPM)
- Direct Drive



SM-89-7500
1/4" Air Screwdriver (800 RPM)
- Direct Drive



Patent No.

US D727,706 S
TW D159601 M510220
Patent Pending in Multi-Countries

Specifications:

Model No.	Free Speed (RPM)	Hex Drive Capacity (Inch)	Torque In-lbs (Nm)	Air Inlet (NPT)	Hose Size ID Inch (mm)	Air Consumption CFM (L/Min)	Length Inch (mm)	Weight Lbs (Kg)
SM-88-7500	1,800	1/4	52 (6)	1/4"	3/8 (10)	4 (113)	7.1 (181)	2.0 (0.9)
SM-89-7500	800	1/4	130 (15)	1/4"	3/8 (10)	4 (113)	7.8 (199)	2.4 (1.1)

* Recommended Air Pressure at 90 PSI (6.2 Bar)

Screwdrivers

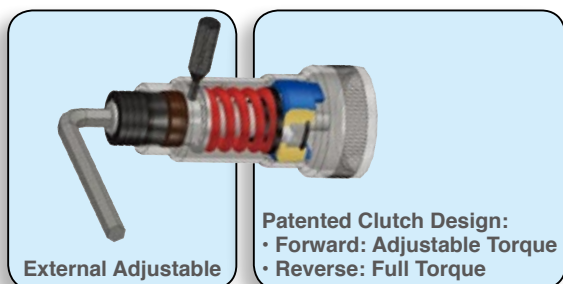

▼ Adjusting springs of 2 different tensions are available for external adjustment of torque.



#802F37-11
Red Spring (ø 3.2 mm)
Torque Range : 20~50 In-lbs



#802F37-12
Blue Spring (ø 3.5 mm)
Torque Range : 40~85 In-lbs

Patent No.

US D727,706 S
TW D159601 M510220
Patent Pending in Multi-Countries

SM-82-7500

1/4" Air Screwdriver (1,800 RPM)
- Adjustable Clutch



SM-83-7500

1/4" Air Screwdriver (800 RPM)
- Adjustable Clutch



SM-84-7500

1/4" Air Screwdriver (1,800 RPM)
- Positive Clutch



SM-86-7500

1/4" Air Screwdriver (800 RPM)
- Positive Clutch



SM-82-7500F

1/4" Air Screwdriver (1,800 RPM)
- External Adjustable Clutch



▲ External Adjustable



SM-83-7500F

1/4" Air Screwdriver (800 RPM)
- External Adjustable Clutch



▲ External Adjustable



Specifications:

Model No.	Free Speed (RPM)	Hex Drive Capacity (Inch)	Torque In-lbs (Nm)	Air Inlet (NPT)	Hose Size ID Inch (mm)	Air Consumption CFM (L/Min)	Length Inch (mm)	Weight Lbs (Kg)
SM-82-7500	1,800	1/4	30~70 (3~8)	1/4"	3/8 (10)	4 (113)	8.3 (210)	2.4 (1.1)
SM-83-7500	800	1/4	30~95 (3~11)	1/4"	3/8 (10)	4 (113)	9 (229)	2.6 (1.2)
SM-84-7500	1,800	1/4	115 (13)	1/4"	3/8 (10)	4 (113)	7.4 (187)	2.2 (1.0)
SM-86-7500	800	1/4	145 (16)	1/4"	3/8 (10)	4 (113)	8.1 (205)	2.4 (1.1)
SM-82-7500F	1,800	1/4	20~50 (2~6)	1/4"	3/8 (10)	4 (113)	8.3 (210)	2.4 (1.1)
SM-83-7500F	800	1/4	40~85 (5~10)	1/4"	3/8 (10)	4 (113)	9 (229)	2.6 (1.2)

* Recommended Air Pressure at 90 PSI (6.2 Bar)

Features:

- **Composite Motor Housing**
- **Variable Speed Trigger**
- Planetary Gear System with Needle Bearings (Option)
- **0.5 HP**



#10035-11
3/8" Standard keyed chuck



#10035-12
3/8" Standard keyless chuck



#10035-13
3/8" Industrial keyed chuck



#10035-14
3/8" Industrial keyless chuck



#75-725139-11S
Side Handle



#822339-11S
Side Handle



#10033-11
1/2" Standard keyed chuck



#10033-12
1/2" Standard keyless chuck



#10033-13
1/2" Industrial keyed chuck



#10033-14
1/2" Industrial keyless chuck

Patent No.

US D727,706 S
TW D159601 M510220
Patent Pending in Multi-Countries

Specifications:

Model No.	Free Speed (RPM)	Chuck Size Inch (mm)	Spindle Thread	Air Inlet (NPT)	Hose Size ID Inch (mm)	Air Consumption CFM (L/Min)	Length Inch (mm)	Weight Lbs (Kg)
SM-75-7500-02	2,000	3/8 (10)	3/8"-24	1/4"	3/8 (10)	4 (113)	7.7 (195)	2.2 (1.0)
SM-74-7500-02	800	1/2 (13)	3/8"-24	1/4"	3/8 (10)	4 (113)	8.6 (219)	2.9 (1.3)
SM-77-7500-02	400	1/2 (13)	3/8"-24	1/4"	3/8 (10)	4 (113)	9.1 (231)	3.3 (1.5)
SM-71-7100-01	2,200	3/8 (10)	3/8"-24	1/4"	3/8 (10)	4 (113)	7.4 (189)	2.2 (1.0)
SM-76-7100-01	2,600	3/8 (10)	3/8"-24	1/4"	3/8 (10)	4 (113)	7.3 (186)	2.2 (1.0)
SM-73-7100-01	500	1/2 (13)	3/8"-24	1/4"	3/8 (10)	4 (113)	9 (228)	3.3 (1.5)

* Recommended Air Pressure at 90 PSI (6.2 Bar)

SM-75-7500-02

3/8" Reversible Air Drill (2,000 RPM)
- Standard Keyless Chuck

▶ Reversible



SM-74-7500-02

1/2" Reversible Air Drill (800 RPM)
- Standard Keyless Chuck

▼ Reversible



SM-77-7500-02

1/2" Reversible Air Drill (400 RPM)
- Standard Keyless Chuck

▼ Reversible



SM-71-7100-01

3/8" Non-Reversible Air Drill (2,200 RPM)
- Standard Keyed Chuck

▶ 2-Gears Type



SM-76-7100-01

3/8" Non-Reversible Air Drill (2,600 RPM)
- Standard Keyed Chuck

▶ 3-Gears Type



SM-73-7100-01

1/2" Non-Reversible Air Drill (500 RPM)
- Standard Keyed Chuck





SUNMATCH
Professional Pneumatic Tools



1/4" Mini Air Drills

Features:

- Full-Cage Gear Design for Better Durability
- Variable Speed Trigger
- Built-In Comfort Grip
- Front Exhaust



SM-7281
1/4" Mini Air Drill (2,800 RPM)
- Standard Keyed Chuck



SM-78-7281R
1/4" Mini Reversible Air Drill (2,500 RPM)
- Standard Keyed Chuck

Features:

- Full-Cage Gear Design for Better Durability
- Variable Speed Trigger
- Built-In Comfort Grip
- Handle Exhaust



SM-7282
1/4" Mini Air Drill (2,800 RPM)
- Standard Keyed Chuck



SM-7282NK
1/4" Mini Air Drill (2,800 RPM)
- Standard Keyless Chuck



SM-7283
1/4" Mini Air Drill (2,800 RPM)
- Standard Keyed Chuck



SM-7283NK
1/4" Mini Air Drill (2,800 RPM)
- Standard Keyless Chuck

Specifications:

Model No.	Free Speed (RPM)	Chuck Size Inch (mm)	Spindle Thread	Air Inlet (NPT)	Hose Size ID Inch (mm)	Air Consumption CFM (L/Min)	Length Inch (mm)	Weight Lbs (Kg)
SM-7281	2,800	1/4 (6)	3/8"-24	1/4"	3/8 (10)	4 (113)	5.5 (140)	1.5 (0.7)
SM-78-7281R	2,500	1/4 (6)	3/8"-24	1/4"	3/8 (10)	4 (113)	6.1 (155)	1.8 (0.8)
SM-7282	2,800	1/4 (6)	3/8"-24	1/4"	3/8 (10)	4 (113)	5.4 (137)	1.5 (0.7)
SM-7282NK	2,800	1/4 (6)	3/8"-24	1/4"	3/8 (10)	4 (113)	5.6 (142)	1.5 (0.7)
SM-7283	2,800	1/4 (6)	3/8"-24	1/4"	3/8 (10)	4 (113)	5.4 (137)	1.5 (0.7)
SM-7283NK	2,800	1/4 (6)	3/8"-24	1/4"	3/8 (10)	4 (113)	5.6 (142)	1.5 (0.7)

* Recommended Air Pressure at 90 PSI (6.2 Bar)

1/4" Mini Air Drills

Features:

- **Composite Motor Housing**
- **1/4" Keyed Chuck or 1/4" Keyless Chuck**
- **Two Speed Trigger**
(Slow speed when pulled halfway)
- Planetary Gear System with Needle Bearings
- Compact Size
- **Patented Silencer 84 dB(A)**



SM-78-7284P-01
with 1/4" Standard keyed chuck



SM-78-7284P-02
with 1/4" Standard keyless chuck



SM-78-7284P-03
with 1/4" Industrial keyed chuck

Composite



SM-78-7284PR-01
with 1/4" Standard keyed chuck



SM-78-7284PR-02
with 1/4" Standard keyless chuck



SM-78-7284PR-03
with 1/4" Industrial keyed chuck

SM-78-7284P

1/4" Non-Reversible Mini Air Drill
(2,600 RPM)
- Standard Keyed Chuck



SM-78-7284P-02

1/4" Non-Reversible Mini Air Drill
(2,600 RPM)
- Standard Keyless Chuck



SM-78-7284PR

1/4" Reversible Mini Air Drill
(2,600 RPM)
- Standard Keyed Chuck



SM-78-7284PR-02

1/4" Reversible Mini Air Drill
(2,600 RPM)
- Standard Keyless Chuck



Specifications:

Model No.	Free Speed (RPM)	Chuck Size Inch (mm)	Spindle Thread	Air Inlet (NPT)	Hose Size ID Inch (mm)	Air Consumption CFM (L/Min)	Length Inch (mm)	Weight Lbs (Kg)	Noise Level dB(A)
SM-78-7284P	2,600	1/4 (6)	3/8"-24	1/4"	3/8 (10)	4 (113)	5.8 (148)	1.3 (0.6)	84
SM-78-7284PR	2,600	1/4 (6)	3/8"-24	1/4"	3/8 (10)	4 (113)	5.8 (148)	1.3 (0.6)	84
SM-78-7284P-02	2,600	1/4 (6)	3/8"-24	1/4"	3/8 (10)	4 (113)	5.8 (148)	1.3 (0.6)	84
SM-78-7284PR-02	2,600	1/4 (6)	3/8"-24	1/4"	3/8 (10)	4 (113)	5.8 (148)	1.3 (0.6)	84

* Recommended Air Pressure at 90 PSI (6.2 Bar)

Features:

- **Composite Motor Housing Double Injection**
- **Two Speed Trigger**
(Slow speed when pulled halfway)
- Reversing Bar on Both Sides
- Planetary Gear System with Needle Bearings (Option)
- **Patented Silencer 83 dB(A)**
- **0.5 HP**



SM-75-7253P-01
with 3/8" Standard keyed chuck



SM-75-7253P-02
with 3/8" Standard keyless chuck



SM-75-7253P-03
with 3/8" Industrial keyed chuck



SM-75-7253P-04
with 3/8" Industrial keyless chuck



#75-725139-11S
Side Handle



SM-74-7253P-01
with 1/2" Standard keyed chuck



SM-74-7253P-02
with 1/2" Standard keyless chuck



SM-74-7253P-03
with 1/2" Industrial keyed chuck



SM-74-7253P-04
with 1/2" Industrial keyless chuck

SM-76-7253P

3/8" Non-Reversible Air Drill
(2,600 RPM)
- Standard Keyless Chuck



Patent No.

US D582,237 S
TW M346502 / M346497 / M350449

SM-75-7253P

3/8" Reversible Air Drill
(1,800 RPM)
- Standard Keyless Chuck



SM-72-7253P

1/2" Non-Reversible Air Drill
(1,000 RPM)
- Standard Keyless Chuck



SM-74-7253P

1/2" Reversible Air Drill
(800 RPM)
- Standard Keyless Chuck



Specifications:

Model No.	Free Speed (RPM)	Chuck Size Inch (mm)	Spindle Thread	Air Inlet (NPT)	Hose Size ID Inch (mm)	Air Consumption CFM (L/Min)	Length Inch (mm)	Weight Lbs (Kg)	Noise Level dB(A)
SM-76-7253P	2,600	3/8 (10)	3/8"-24	1/4"	3/8 (10)	4 (113)	7.8 (197)	2.4 (1.1)	83
SM-75-7253P	1,800	3/8 (10)	3/8"-24	1/4"	3/8 (10)	4 (113)	7.8 (197)	2.4 (1.1)	83
SM-72-7253P	1,000	1/2 (13)	3/8"-24	1/4"	3/8 (10)	4 (113)	8.6 (218)	2.9 (1.3)	83
SM-74-7253P	800	1/2 (13)	3/8"-24	1/4"	3/8 (10)	4 (113)	8.6 (218)	2.9 (1.3)	83

* Recommended Air Pressure at 90 PSI (6.2 Bar)

Features:

- **Composite Motor Housing**
- **Two Speed Trigger**
Slow speed when pulled halfway
- Reversing Bar on Both Sides
- Planetary Gear System with Needle Bearings (Option)
- **Patented Silencer 83 dB(A)**
- **0.5 HP**



SM-75-7254P-01
with 3/8" Standard keyed chuck



SM-75-7254P-02
with 3/8" Standard keyless chuck



SM-75-7254P-03
with 3/8" Industrial keyed chuck



SM-75-7254P-04
with 3/8" Industrial keyless chuck



#75-725139-11S
Side Handle



SM-74-7254P-01
with 1/2" Standard keyed chuck



SM-74-7254P-02
with 1/2" Standard keyless chuck



SM-74-7254P-03
with 1/2" Industrial keyed chuck



SM-74-7254P-04
with 1/2" Industrial keyless chuck

SM-76-7254P

3/8" Non-Reversible Air Drill
(2,600 RPM)
- Standard Keyless Chuck



Patent No.

US D582,236 S
TW M346502 / M346497 / M350449

SM-75-7254P

3/8" Reversible Air Drill
(1,800 RPM)
- Standard Keyless Chuck



SM-72-7254P

1/2" Non-Reversible Air Drill
(1,000 RPM)
- Standard Keyless Chuck



SM-74-7254P

1/2" Reversible Air Drill
(800 RPM)
- Standard Keyless Chuck



Specifications:

Model No.	Free Speed (RPM)	Chuck Size Inch (mm)	Spindle Thread	Air Inlet (NPT)	Hose Size ID Inch (mm)	Air Consumption CFM (L/Min)	Length Inch (mm)	Weight Lbs (Kg)	Noise Level dB(A)
SM-76-7254P	2,600	3/8 (10)	3/8"-24	1/4"	3/8 (10)	4 (113)	7.8 (197)	2.4 (1.1)	83
SM-75-7254P	1,800	3/8 (10)	3/8"-24	1/4"	3/8 (10)	4 (113)	7.8 (197)	2.4 (1.1)	83
SM-72-7254P	1,000	1/2 (13)	3/8"-24	1/4"	3/8 (10)	4 (113)	8.6 (218)	2.9 (1.3)	83
SM-74-7254P	800	1/2 (13)	3/8"-24	1/4"	3/8 (10)	4 (113)	8.6 (218)	2.9 (1.3)	83

* Recommended Air Pressure at 90 PSI (6.2 Bar)

Features:

- Composite Motor Housing
- Lightweight



SM-751P-02

3/8" Heavy Duty Air Drill (2,200 RPM)
- Standard Keyless Chuck

► Full-Cage Gear Design



SM-751P-04

3/8" Heavy Duty Air Drill (2,200 RPM)
- Industrial Keyless Chuck

► Full-Cage Gear Design



SM-7951P-02

3/8" Reversible Air Drill (1,800 RPM)
- Standard Keyless Chuck



SM-7951P-04

3/8" Reversible Air Drill (1,800 RPM)
- Industrial Keyless Chuck



SM-7941P-02

1/2" Reversible Air Drill (800 RPM)
- Standard Keyless Chuck



SM-7941P-04

1/2" Reversible Air Drill (800 RPM)
- Industrial Keyless Chuck

Specifications:

Model No.	Free Speed (RPM)	Chuck Size Inch (mm)	Spindle Thread	Air Inlet (NPT)	Hose Size ID Inch (mm)	Air Consumption CFM (L/Min)	Length Inch (mm)	Weight Lbs (Kg)
SM-751P-02	2,200	3/8 (10)	3/8"-24	1/4"	3/8 (10)	4 (113)	7.1 (180)	2.5 (1.1)
SM-751P-04	2,200	3/8 (10)	3/8"-24	1/4"	3/8 (10)	4 (113)	7 (179)	2.5 (1.1)
SM-7951P-02	1,800	3/8 (10)	3/8"-24	1/4"	3/8 (10)	4 (113)	7 (179)	3 (1.4)
SM-7951P-04	1,800	3/8 (10)	3/8"-24	1/4"	3/8 (10)	4 (113)	7 (177)	3 (1.4)
SM-7941P-02	800	1/2 (13)	3/8"-24	1/4"	3/8 (10)	4 (113)	8 (203)	4 (1.8)
SM-7941P-04	800	1/2 (13)	3/8"-24	1/4"	3/8 (10)	4 (113)	8.1 (205)	4 (1.8)

* Recommended Air Pressure at 90 PSI (6.2 Bar)

Features:

- **Ergonomic Handle Design**
- **Variable Speed Trigger**
- Planetary Gear System with Needle Bearings (Option)
- Built-in Comfort Grip
- Forward and Reverse Control on Top & Painted in Red
- Rotating Air Inlet
- Handle Exhaust
- **Low Noise 83 dB(A)**



SM-76-7063-03

3/8" Non-Reversible Air Drill (2,600 RPM)
- Industrial Keyed Chuck



SM-75-7251-03

3/8" Reversible Air Drill (1,800 RPM)
- Industrial Keyed Chuck



SM-72-7063-03

1/2" Non-Reversible Air Drill (1,000 RPM)
- Industrial Keyed Chuck



SM-73-7063-03

1/2" Non-Reversible Air Drill (500 RPM)
- Industrial Keyed Chuck



SM-73-7251-03

1/2" Reversible Air Drill (400 RPM)
- Industrial Keyed Chuck



SM-74-7251-03

1/2" Reversible Air Drill (800 RPM)
- Industrial Keyed Chuck

Specifications:

Model No.	Free Speed (RPM)	Chuck Size Inch (mm)	Spindle Thread	Air Inlet (NPT)	Hose Size ID Inch (mm)	Air Consumption CFM (L/Min)	Length Inch (mm)	Weight Lbs (Kg)	Noise Level dB(A)
SM-76-7063-03	2,600	3/8 (10)	3/8"-24	1/4"	3/8 (10)	4 (113)	7.4 (187)	2.6 (1.2)	83
SM-75-7251-03	1,800	3/8 (10)	3/8"-24	1/4"	3/8 (10)	4 (113)	7.4 (187)	2.9 (1.3)	83
SM-72-7063-03	1,000	1/2 (13)	3/8"-24	1/4"	3/8 (10)	4 (113)	8.8 (224)	3.5 (1.6)	83
SM-73-7063-03	500	1/2 (13)	3/8"-24	1/4"	3/8 (10)	4 (113)	9.2 (233)	4 (1.8)	83
SM-73-7251-03	400	1/2 (13)	3/8"-24	1/4"	3/8 (10)	4 (113)	9.2 (233)	4 (1.8)	83
SM-74-7251-03	800	1/2 (13)	3/8"-24	1/4"	3/8 (10)	4 (113)	8.8 (224)	3.7 (1.7)	83

* Recommended Air Pressure at 90 PSI (6.2 Bar)

Features:

- Built-in Comfort Grip
- Rear Exhaust
- Variable Speed Trigger



SM-7915

3/8" Standard Duty Air Drill (2,600 RPM)
- Standard Keyed Chuck

- ▶ 3 Gears



SM-7955

3/8" Reversible Air Drill (1,800 RPM)
- Standard Keyed Chuck



SM-7985

3/8" Heavy Duty Air Drill (4,800 RPM)
- Standard Keyed Chuck

- ▶ Full-Cage Gear Design



SM-7511

3/8" Heavy Duty Air Drill (2,200 RPM)
- Standard Keyed Chuck

- ▶ Full-Cage Gear Design



SM-7531

1/2" Heavy Duty Air Drill (500 RPM)
- Standard Keyed Chuck

- ▶ Full-Cage Gear Design



SM-7935

1/2" Air Drill (1,000 RPM)
- Standard Keyed Chuck

Specifications:

Model No.	Free Speed (RPM)	Chuck Size Inch (mm)	Spindle Thread	Air Inlet (NPT)	Hose Size ID Inch (mm)	Air Consumption CFM (L/Min)	Length Inch (mm)	Weight Lbs (Kg)
SM-7915	2,600	3/8 (10)	3/8"-24	1/4"	3/8 (10)	4 (113)	7.2 (184)	2.6 (1.2)
SM-7955	1,800	3/8 (10)	3/8"-24	1/4"	3/8 (10)	4 (113)	7.2 (184)	2.6 (1.2)
SM-7985	4,800	3/8 (10)	3/8"-24	1/4"	3/8 (10)	4 (113)	7.2 (184)	3.5 (1.6)
SM-7511	2,200	3/8 (10)	3/8"-24	1/4"	3/8 (10)	4 (113)	7.5 (191)	2.6 (1.2)
SM-7531	500	1/2 (13)	3/8"-24	1/4"	3/8 (10)	4 (113)	9.3 (235)	3.5 (1.6)
SM-7935	1,000	1/2 (13)	3/8"-24	1/4"	3/8 (10)	4 (113)	8.5 (216)	3.3 (1.5)

* Recommended Air Pressure at 90 PSI (6.2 Bar)

Features:

- Triple Full-Cage Design and Gears with Oilless Bushing to Ensure of Heavy Duty Gearing System
- Spring Loaded Rotor Vanes to Ensure of the Rotor Blades Fully Functioned (SM-7952-04 & SM-7942-03)
- Ergonomic Handle Design
- Built-in Comfort Grip
- Short Gear Case Design in the Front of Motor Housing
- with Dead Handle
- Handle Exhaust
- **Low Noise** (SM-7845-02, SM-7945-02, SM-7955-02)



SM-7955-02
3/8" Reversible Air Drill (1,650 RPM)
- Standard Keyless Chuck

▼ Short Gear Case Design in the Front of Motor Housing



SM-7942-03
1/2" Reversible Air Drill (500 RPM)
- Industrial Keyed Chuck

▼ Short Gear Case Design in the Front of Motor Housing



SM-7952-04
3/8" Reversible Air Drill (1,800 RPM)
- Industrial Keyless Chuck



SM-7845-02
1/2" Reversible Air Drill (350 RPM)
- Standard Keyless Chuck



SM-7945-02
1/2" Reversible Air Drill (650 RPM)
- Standard Keyless Chuck

Specifications:

Model No.	Free Speed (RPM)	Chuck Size Inch (mm)	Spindle Thread	Air Inlet (NPT)	Hose Size ID Inch (mm)	Air Consumption CFM (L/Min)	Length Inch (mm)	Weight Lbs (Kg)
SM-7845-02	350	1/2 (13)	3/8"-24	1/4"	3/8 (10)	4 (113)	8.3 (210)	3.5 (1.6)
SM-7945-02	650	1/2 (13)	3/8"-24	1/4"	3/8 (10)	4 (113)	7.8 (197)	3.0 (1.4)
SM-7955-02	1,650	3/8 (10)	3/8"-24	1/4"	3/8 (10)	4 (113)	7 (178)	2.6 (1.2)
SM-7942-03	500	1/2 (13)	3/8"-24	1/4"	3/8 (10)	4 (113)	9 (229)	3.8 (1.7)
SM-7952-04	1,800	3/8 (10)	3/8"-24	1/4"	3/8 (10)	4 (113)	8 (203)	3.2 (1.5)

* Recommended Air Pressure at 90 PSI (6.2 Bar)

3/8" Heavy Duty Angle Drills

Features:

- 90 Degree Angle Head
- **with Industrial Keyed Chuck** (Optional)
- Rear Exhaust
- Built-in Comfort Grip (SM-79-8423R)
- **Low Noise**



▲ Operation of 3/8" Reversible Angle Drill

SM-7091R

3/8" Reversible Angle Drill (1,200 RPM)
- Industrial Keyed Chuck



▲ Forward and Reverse

SM-79-8423R

3/8" Reversible Angle Drill (1,400 RPM)
- Industrial Keyed Chuck



▲ Forward and Reverse

Specifications:

Model No.	Free Speed (RPM)	Chuck Size Inch (mm)	Spindle Thread	Air Inlet (NPT)	Hose Size ID Inch (mm)	Air Consumption CFM (L/Min)	Length Inch (mm)	Weight Lbs (Kg)	Noise Level dB(A)
SM-7091R	1,200	3/8 (10)	3/8"-24	1/4"	3/8 (10)	4 (113)	8 (203)	2.5 (1.1)	-
SM-79-8423R	1,400	3/8 (10)	3/8"-24	1/4"	3/8 (10)	4 (113)	8.4 (214)	2.6 (1.2)	85

* Recommended Air Pressure at 90 PSI (6.2 Bar)

Air Metal Shears

Features:

- **Cutting Capacity Steel 1.2 mm**
- Built-in Comfort Grip
- Variable Speed Trigger
- Rear Exhaust



▲ Operation of Air Metal Shear

SM-28-7063

Air Metal Shear



SM-2945

Air Metal Shear



Specifications:

Model No.	Free Speed (RPM)	Cutting Capacity Steel (mm)	Air Inlet (NPT)	Hose Size ID Inch (mm)	Air Consumption CFM (L/Min)	Length Inch (mm)	Weight Lbs (Kg)
SM-28-7063	2,600	1.2	1/4"	3/8 (10)	4 (113)	8.5 (217)	2.9 (1.3)
SM-2945	2,600	1.2	1/4"	3/8 (10)	4 (113)	8.5 (217)	3 (1.4)

* Recommended Air Pressure at 90 PSI (6.2 Bar)

0.5 HP & 1.0 HP Air Drills

Features:

- **Two Speed Trigger**
(Slow speed when pulled halfway)
- Planetary Gear System
- **0.5 HP & 1.0 HP**

SM-7029B

3/8" Air Drill
- 3,200 RPM
- 0.5 HP

SM-7038B

3/8" Air Drill
- 3,900 RPM
- 0.5 HP

SM-7138B

1/4" Air Drill
- 3,900 RPM
- 0.5 HP



SM-7017B

3/8" Air Drill
- 1,900 RPM
- 0.5 HP



Optional!



#7017B56-11S
Side Handle
(Optional)

SM-7026A

3/8" Air Drill
- 2,600 RPM
- 1.0 HP

SM-7032A

3/8" Air Drill
- 3,200 RPM
- 1.0 HP

SM-7060A

3/8" Air Drill
- 6,000 RPM
- 1.0 HP



SM-7160A

1/4" Air Drill
- 6,000 RPM
- 1.0 HP

SM-7005A

1/2" Air Drill
- 500 RPM
- 1.0 HP

SM-7009A

1/2" Air Drill
- 900 RPM
- 1.0 HP



#75-725139-11S
Side Handle

Specifications:

Model No.	Free Speed (RPM)	Chuck Size Inch (mm)	Air Inlet (NPT)	Hose Size ID Inch (mm)	Air Consumption CFM (L/Min) Free Speed	Spindle Thread	Length Inch (mm)	Weight Lbs (Kg)	Power HP (Watt)
SM-7029B	3,200	3/8 (10)	1/4"	3/8 (10)	24.7 (700)	3/8"-24	7.6 (194)	1.5 (0.7)	0.5 (373)
SM-7038B	3,900	3/8 (10)	1/4"	3/8 (10)	24.7 (700)	3/8"-24	7.6 (194)	1.5 (0.7)	0.5 (373)
SM-7138B	3,900	1/4 (6)	1/4"	3/8 (10)	24.7 (700)	3/8"-24	6.5 (165)	1.3 (0.6)	0.5 (373)
SM-7017B	1,900	3/8 (10)	1/4"	3/8 (10)	24.7 (700)	3/8"-24	8.9 (225)	2.2 (1.0)	0.5 (373)
SM-7026A	2,600	3/8 (10)	1/4"	3/8 (10)	29.7 (840)	3/8"-24	7.9 (200)	2.2 (1.0)	1.0 (746)
SM-7032A	3,200	3/8 (10)	1/4"	3/8 (10)	29.7 (840)	3/8"-24	7.9 (200)	2.2 (1.0)	1.0 (746)
SM-7060A	6,000	3/8 (10)	1/4"	3/8 (10)	29.7 (840)	3/8"-24	7.9 (200)	2.2 (1.0)	1.0 (746)
SM-7160A	6,000	1/4 (6)	1/4"	3/8 (10)	29.7 (840)	3/8"-24	7.6 (193)	2.0 (0.9)	1.0 (746)
SM-7005A	500	1/2 (13)	1/4"	3/8 (10)	29.7 (840)	3/8"-24	9.6 (243)	2.9 (1.3)	1.0 (746)
SM-7009A	900	1/2 (13)	1/4"	3/8 (10)	29.7 (840)	3/8"-24	9.6 (243)	2.9 (1.3)	1.0 (746)

* Recommended Air Pressure at 90 PSI (6.2 Bar)

0.5 HP Air Drills

SM-7017C-03

3/8" Air Drill (1,900 RPM)

- Industrial Keyed Chuck
- 0.5 HP



SM-7029C-03

3/8" Air Drill (3,200 RPM)

- Industrial Keyed Chuck
- 0.5 HP

SM-7038C-03

3/8" Air Drill (3,900 RPM)

- Industrial Keyed Chuck
- 0.5 HP

SM-7138C-03

1/4" Air Drill (3,900 RPM)

- Industrial Keyed Chuck
- 0.5 HP



Features:

- Long Life Time
- Planetary Gear System
- Side Handle (Optional)
- 0.5 HP

Optional!



#7017B56-12S
Side Handle
(Optional)

SM-7017C-08

3/8" Air Drill (1,900 RPM)

- Industrial Keyless Chuck
- 0.5 HP



SM-7029C-08

3/8" Air Drill (3,200 RPM)

- Industrial Keyless Chuck
- 0.5 HP

SM-7038C-08

3/8" Air Drill (3,900 RPM)

- Industrial Keyless Chuck
- 0.5 HP



Specifications:

Model No.	Free Speed (RPM)	Chuck Size Inch (mm)	Air Inlet (NPT)	Hose Size ID Inch (mm)	Air Consumption CFM (L/Min) Free Speed	Spindle Thread	Length Inch (mm)	Weight Lbs (Kg)	Power HP (Watt)
SM-7017C-03	1,900	3/8(10)	1/4"	3/8 (10)	24.7 (700)	3/8"-24	8.9 (226)	2.2 (1.0)	0.5 (373)
SM-7029C-03	3,200	3/8(10)	1/4"	3/8 (10)	24.7 (700)	3/8"-24	7.7 (195)	1.8 (0.8)	0.5 (373)
SM-7038C-03	3,900	3/8(10)	1/4"	3/8 (10)	24.7 (700)	3/8"-24	7.7 (195)	1.8 (0.8)	0.5 (373)
SM-7138C-03	3,900	3/8(10)	1/4"	3/8 (10)	24.7 (700)	3/8"-24	7.3 (186)	1.5 (0.7)	0.5 (373)
SM-7017C-08	1,900	3/8(10)	1/4"	3/8 (10)	24.7 (700)	3/8"-24	9.6 (244)	2.4 (1.1)	0.5 (373)
SM-7029C-08	3,200	3/8(10)	1/4"	3/8 (10)	24.7 (700)	3/8"-24	8.4 (213)	2.0 (0.9)	0.5 (373)
SM-7038C-08	3,900	3/8(10)	1/4"	3/8 (10)	24.7 (700)	3/8"-24	8.4 (213)	2.0 (0.9)	0.5 (373)

* Recommended Air Pressure at 90 PSI (6.2 Bar)

Spot Drill

- with Enforced Lever



- Low Speed **800 RPM**
- High Torque
- 360° Swivel Steady Frame
- Tungsten Carbide Drill Bit (Optional)
- Low Noise **84 dB(A)**



Features:

- Low Speed **800 RPM** / High Torque
- **360° Swivel** on The Steady Frame
- **Tungsten Carbide Drill Bit** (Optional)
- Built-in Comfort Grip
- Handle Exhaust
- **Low Noise 84 dB(A)**



▲ Operation of Spot Drill



▲ Operation of Spot Drill

📺 **Demonstration on website :** <http://www.sunmatch.com/video.html>

SM-71-7802K

Spot Drill Kit



Accessories (Optional) :

3-Edge Cutter Tungsten Carbide Drill Bit

-  **#71-780139**
ø 10.3 x 47 mm
-  **#71-780140**
ø 8.3 x 47 mm
-  **#71-780141**
ø 6.3 x 47 mm

SM-71-7802

Spot Drill
- with Enforced Lever
(Drill Bit not included)



Patent No.

US 8292552 B2 / DE 20 2008 015 552 U1
TW M349809 / TW M349810
Patent Pending in Multi-Countries

▼ **Steps to use Spot Drill**



Step 1

Adjust the steady frame position and point drill bit at the metal plate.



Step 2

Push the enforced lever to have drill bit touch the metal plate easily.



Step 3

Push the throttle lever to start and use enforced lever to move the drill bit forward.

SM-721K

Spot Weld Drill Kit



Kit Includes:

- 1 pc SM-721 Spot Weld Drill
- 3 pcs 8 mm Drill Bit
- 1 pc 6.5 mm Drill Bit
- 1 pc Mini Oiler
- 1 pc 1/4" x 1/4" Swivel Joint
- 1 pc Nipple
- 1 pc Hex. Wrench
- 1 pc Blow Case

SM-721

Spot Weld Drill
- with 8 mm Drill Bit



▲ Optional : 6.5 mm Drill Bit

Specifications:

Model No.	Free Speed (RPM)	Drill Bit Size (mm)	Air Inlet (NPT)	Hose Size ID Inch (mm)	Air Consumption CFM (L/Min)	Length Inch (mm)	Weight Lbs (Kg)	Noise Level dB(A)
SM-71-7802	800	ø 6.3 , ø 8.3 , ø 10.3 x 47 (L)	1/4"	3/8 (10)	4 (113)	13.7 (349)	5.5 (2.5)	84
SM-721	2,000	ø 6.5 , ø 8 x 44 (L)	1/4"	3/8 (10)	4 (113)	9.8 (249)	5.6 (2.5)	84

* Recommended Air Pressure at 90 PSI (6.2 Bar)

Bead Breaker

Features:

- Easy to Use Gain Time Assured
- Intervention Directly on Vehicle
- Handle Exhaust
- Air Regulator

SM-4040

Bead Breaker
- Special Agricultural

- Race Actuator 3.1" (80 mm)
- Opening Jaw 2.7" (68 mm)
- Length 15.6" (396 mm)
- Weight 10.2 lbs (4.6 kg)



📺 *Demonstration on website : <http://www.sunmatch.com/video.html>*



▲ Operation of Bead Breaker



**Easy to use
Gain time assured!**

Specifications:

Model No.	Opening Jaw Inch (mm)	Race Actuator Inch (mm)	Air Inlet (NPT)	Hose Size ID Inch (mm)	Air Consumption CFM (L/Min)	Length Inch (mm)	Weight Lbs (Kg)
SM-4040	2.7 (68)	3.1 (80)	1/4"	3/8 (10)	4 (113)	15.6 (396)	10.2 (4.6)

* Recommended Air Pressure at 90 PSI (6.2 Bar)

Wheel Bolt Cleaner Kit

Features:

- Free Speed 1,800 R.P.M.
- Cleaning Tool for Rust & Dirt of Heavy Vehicle's Wheel
- For Precise Fastening Torque Control

Improvement in Efficiency with Wheel Bolt Cleaner



📺 **Demonstration on website :**
<http://www.sunmatch.com/video.html>



Driver retainer for quick accessories change



Wire Brushes

(For Outer Nuts & Inside of Inner Nuts)



Bolt Hole Cleaner

A Part Applies Oil

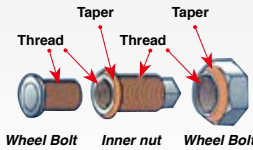

Please apply the oil to the thread after cleaning

Road trucking vehicle law has been amended in order to avoid the accident by run off the tire.

(Inspection when mounting wheels)

Screw Cleaners

(For Inner Nut, Inner Bolt, Hub Bolt)



Patent No.

DE 20 2009 006 267 U1
 TW M365294
 JP 3155174
 US 8,032,970 B2
 Patent Pending in Multi-Countries

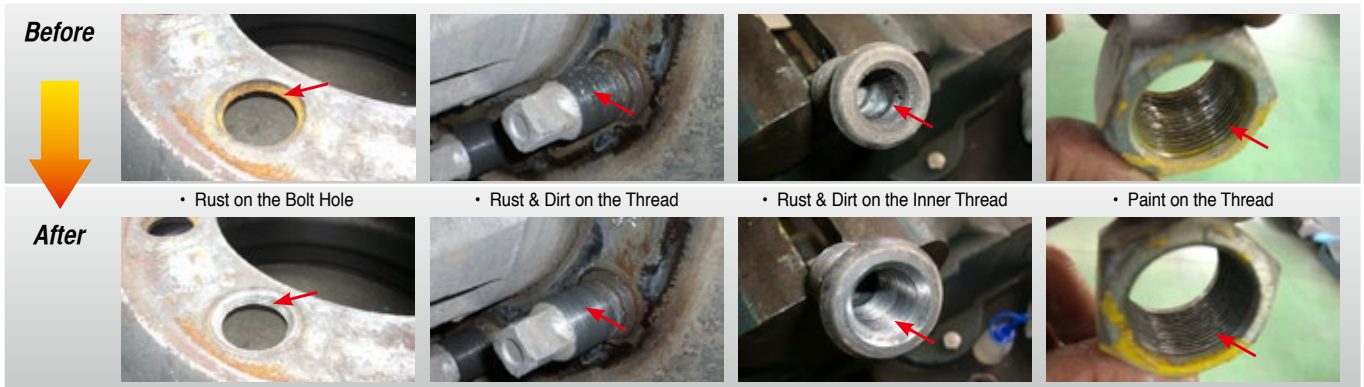

Heavy-Duty Air Drill

Features:

- Free Speed 2,800 RPM
- Gears with Needle Bearings
- **Oil Free** Rotor Blades
- **0.75 HP**

0.75 HP



SM-706L
3/8" Heavy-Duty Air Drill

Specifications :

Model No.	Free Speed (RPM)	Chuck Size Inch (mm)	Air Inlet (NPT)	Hose Size ID Inch (mm)	Air Consumption CFM (L/Min)	Spindle Thread	Length Inch (mm)	Weight Lbs (Kg)	Horse Power (HP)
SM-706L	2,800	3/8 (10)	1/4"	3/8 (10)	4 (113)	3/8"-24	8 (203)	2.9 (1.3)	0.75

* Recommended Air Pressure at 90 PSI (6.2 Bar)

Heavy-Duty Industrial Pneumatic Drills

Features:

- Dead Handle on Either Side of Motor Housing
- D-type Handle with Inside Trigger

SM-7H-7535
Industrial Air Drill (13 mm)



SM-7H-7538
Industrial Air Drill (16 mm)



SM-7H-7535
with 1/2" (13 mm) Industrial Keyed Chuck



SM-7H-7538
with 5/8" (16 mm) Industrial Keyed Chuck

Specifications:

Model No.	Free Speed (RPM)	Chuck Size Inch (mm)	Spindle Thread	Power (Watt)	Air Inlet (NPT)	Hose Size ID Inch (mm)	Air Consumption CFM (L/Min)	Length Inch (mm)	Weight Lbs (Kg)
SM-7H-7535	1,200	1/2 (13)	1/2"-20	820W	3/8"	1/2 (13)	5 (142)	14.1 (358)	7.1 (3.2)
SM-7H-7538	800	5/8 (16)	1/2"-20	820W	3/8"	1/2 (13)	5 (142)	14.5 (369)	7.9 (3.6)

* Recommended Air Pressure at 90 PSI (6.2 Bar)

Four Bolt Chipping Hammers

Features:

- Heat Treated Precision Cylinder and Piston for Long Life
- Heavy-duty Hammer Provides Hard-hitting Powerful Blows
- Replaceable Bushing, Hex and Round Types
- Available with Four Different Stroke Lengths, Wide Selection to Suit the Job

SM-DR-100V

1" Chipping Hammer
- Bushing Size: 0.680 Round

SM-DH-100V

1" Chipping Hammer
- Bushing Size: 0.580 Hex



SM-DR-200V

2" Chipping Hammer
- Bushing Size: 0.680 Round

SM-DH-200V

2" Chipping Hammer
- Bushing Size: 0.580 Hex



SM-DR-300V

3" Chipping Hammer
- Bushing Size: 0.680 Round

SM-DH-300V

3" Chipping Hammer
- Bushing Size: 0.580 Hex



SM-DR-400V

4" Chipping Hammer
- Bushing Size: 0.680 Round

SM-DH-400V

4" Chipping Hammer
- Bushing Size: 0.580 Hex



Specifications:

Model No.	Bushing Size (Inch)	Blows Per Minute	Bore Size Inch (mm)	Stroke Length	Air Inlet (NPT)	Hose Size ID Inch (mm)	Air Consumption CFM (L/Min)	Length Inch (mm)	Weight Lbs (Kg)
SM-DR-100V	0.680 Round	2,450	1-1/8 (28)	2.5"	3/8"	1/2 (13)	6 (150)	13.6 (345)	16 (7.3)
SM-DH-100V	0.580 Hex	2,450	1-1/8 (28)	2.5"	3/8"	1/2 (13)	6 (150)	13.6 (345)	16 (7.3)
SM-DR-200V	0.680 Round	2,300	1-1/8 (28)	3.0"	3/8"	1/2 (13)	6.5 (165)	14.5 (369)	17 (7.7)
SM-DH-200V	0.580 Hex	2,300	1-1/8 (28)	3.0"	3/8"	1/2 (13)	6.5 (165)	14.5 (369)	17 (7.7)
SM-DR-300V	0.680 Round	2,100	1-1/8 (28)	3.75"	3/8"	1/2 (13)	7.5 (190)	15.6 (397)	18 (8.4)
SM-DH-300V	0.580 Hex	2,100	1-1/8 (28)	3.75"	3/8"	1/2 (13)	7.5 (190)	15.6 (397)	18 (8.4)
SM-DR-400V	0.680 Round	1,700	1-1/8 (28)	4.25"	3/8"	1/2 (13)	8.3 (211)	16.8 (426)	19 (8.9)
SM-DH-400V	0.580 Hex	1,700	1-1/8 (28)	4.25"	3/8"	1/2 (13)	8.3 (211)	16.8 (426)	19 (8.9)

* Recommended Air Pressure at 90 PSI (6.2 Bar)

Features:

- Large Diameter, Smooth Stroke Piston
- All Shank Sizes Accommodate Standard Steel
- Four-Bolt Head-to-Cylinder Construction
- Efficient Valve Chest for Low-Maintenance
- Replaceable Front Head Bushing
- **Full Control Throttle**
- **Drop-Forged Cylinder**
- Chisel Retainer Latch
- Rubber Handle Grips

SM-P611

Paving Breaker

Shank Size : 1-1/8"x6"

SM-P612

Paving Breaker

Shank Size : 1-1/4"x6"



26.5" (672 mm)

SM-P911

Paving Breaker

Shank Size : 1-1/8"x6"

SM-P912

Paving Breaker

Shank Size : 1-1/4"x6"



29.6" (752 mm)

Specifications :

Model No.	Piston Diameter Inch (mm)	Piston Stroke Inch (mm)	Blow Per Min. (BPM)	Air Inlet (NPT)	Hose Size ID Inch (mm)	Shank Size Inch (mm)	Air Consumption CFM (L/Min)	Overall Length Inch (mm)	Weight Lbs (Kg)
SM-P611	2-1/4 (57.15)	4 (100)	1,400	3/4"	3/4 (19)	1-1/8x6 (28x152)	70 (2,000)	26.5 (672)	66 (30)
SM-P612	2-1/4 (57.15)	4 (100)	1,400	3/4"	3/4 (19)	1-1/4x6 (32x152)	70 (2,000)	26.5 (672)	66 (30)
SM-P911	2-5/8 (66.67)	6 (152)	1,250	3/4"	3/4 (19)	1-1/8x6 (28x152)	77 (2,200)	29.6 (752)	92.4 (42)
SM-P912	2-5/8 (66.67)	6 (152)	1,250	3/4"	3/4 (19)	1-1/4x6 (32x152)	77 (2,200)	29.6 (752)	92.4 (42)

* Recommended Air Pressure at 90 PSI (6.2 Bar)

Air Scribe and Engraving Chisel

Features:

- Provides Sufficient Power for Engraving & Mini Chipping Applications
- High Precision Throttle Ensures Critical Control
- Best for : Precision Engraving of Metals, Stone and Marble

SM-10-1001

Scribe / Engraving Chisel



SM-10-1001K

Scribe / Engraving Chisel Kit

In Blow Molded Case Complete with:

- 1 pc SM-10-1001 Scribe / Engraving Chisel
- 1 pc #100113-11S Air Filter Assembly
- 1 pc #100108-11S Chisel Joint for Use with Chisels
- 1 pc #10-100109 Pen Chisel - Tungsten Carbide Tipped / Writing & Engraving
- 1 pc #10-100110 Chisel A / Customize to Suit
- 1 pc #10-100111 Chisel B / Cutting & Deburring
- 1 pc #10-100112 Chisel C / Scaling & Deburring



#10-100113-11S
Air Filter Assembly



#10-100108-11S
Chisel Joint



#10-100109
Pen Chisel



#10-100110
Chisel A



#10-100111
Chisel B



#10-100112
Chisel C

Specifications :

Model No.	Blows Per Min. (BPM)	Bushing Size Inch (mm)	Bore Size Inch (mm)	Stroke Length Inch (mm)	Air Inlet (NPT)	Hose Size ID Inch (mm)	Air Consumption CFM (L/Min)	Length Inch (mm)	Weight Lbs (Kg)
SM-10-1001	13,500	1/8" (3.175)	0.228 (5.8)	0.323 (8.2)	1/4"	1/4" (6.35)	1.1 (31)	4.8 (122)	0.3 (0.14)

* Recommended Air Pressure at 90 PSI (6.2 Bar)

Wheel Bolt Cleaner Kit

Features:

- Easy to Work with 1/2" Impact Wrenches, Drills or Screwdrivers
- Cleaning Tool for Rust & Dirt of Heavy Vehicle's Wheel
- Multi-Functioned

SM-B4WSA Wheel Bolt Cleaner Kit



**Best at
2,000 RPM**



Wire Brushes

(For Outer Nuts & Inside of Inner Nuts)



Screw Cleaners

(For Inner Nut, Inner Bolt, Hub Bolt)

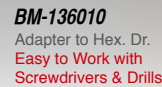

Spare Brushes (For Screw Cleaners)



BM-136012 **BM-243712**
For B4-1360 For B4-2437
BM-203712 **BM-306012**
For B4-2037 For B4-3060
BM-223712
For B4-2237 & B4-2285

Before



After



Wheel Hub Bolt Grinder Kit

Features:

- Easy to work with 1/2" Impact Wrenches
- Special grinder is used to clean the wheel rim
Contact surface, designed for vehicles with stud bolts
- Remove corrosion quickly and easily
- Wear-resistant : approx. 50 vehicles per wheel
- Suitable for stud bolt size : M12, M14, 1/2" & 9/16"



B4-14K

Wheel Hub Bolt Grinder Kit

Kit Includes:

- 1 pc B4-1401 Impact driven holder
- 3 pcs B4-1440 Spare grinding wheel Dia. 40 mm
- 3 pcs B4-1450 Spare grinding wheel Dia. 50 mm



**Best at
2,000 RPM**



B4-1401
Impact driven holder



40 mm

B4-1440
Spare grinding wheel
Dia. 40 mm



50 mm

B4-1450
Spare grinding wheel
Dia. 50 mm

Patent No.

TW M532925
Patent Pending in Multi-Countries

Utility Sanding Kit

Features:

- Easy to work with 1/2" Impact Wrenches
- Multi-Functioned

Patent No.

TW M532925

Patent Pending in Multi-Countries



1/2" Drive

**Best at
2,000 RPM**

Spare Grinding Wheels



B4-1440
Spare grinding wheel
Dia. 40 mm



B4-1450
Spare grinding wheel
Dia. 50 mm

Velcro Sanding Pads



B4-1425
2" Velcro Sanding Pad



B4-1426
3" Velcro Sanding Pad



▲ 1/2" Drive

B4-1401
Impact driven holder

Sanding Backup Pads



B4-1427
2" Sanding Backup Pad



B4-1428
3" Sanding Backup Pad

Wheel Hub Grinder

Features:

- Easy to work with 1/2" Impact Wrenches, Drills or Screwdrivers
- Special grinder is used to clean the wheel and hub contact surface
- Remove corrosion quickly and easily
- Hook and loop back for quick changing of grinding wheels
- Wear-resistant : approx. 100 vehicles per wheel

**Best at
1,500 RPM**



▲ to Work with 1/2" Impact Wrenches



B4-160/65

Wheel Hub Grinder ϕ 160 mm
1 holder + 1 spare wheel (hole : 65 mm)

B4-160/75

Wheel Hub Grinder ϕ 160 mm
1 holder + 1 spare wheel (hole : 75 mm)



▲ to Work with Screwdrivers / Drills

Accessories (Optional) :



Optional!

BM-136010

Adapter to Hex. Dr.
Easy to Work with Drills
& Screwdrivers



Optional!

#B4-16065

Spare wheel ϕ 160 mm x ϕ 65 mm

#B4-16075

Spare wheel ϕ 160 mm x ϕ 75 mm

Patent No.

TW M531352
Patent Pending in Multi-Countries

Exhaust Hose Assembly



SM-522SH
1/4" Mini Angle Die Grinder
- with Exhaust Hose Kit



EH-522SUB
Exhaust Hose Assembly (Optional)

▲ For Use on All Series Mini Die Grinders
and SM-6102P Angle Polisher



SM-55-5227SH
1/4" 115° Mini Angle Die Grinder
- with Exhaust Hose Kit



SM-512SH
1/4" Die Grinder (Full Size)
- with Exhaust Hose Kit



EH-512SUB
Exhaust Hose Assembly (Optional)

▲ For Use on All Series Die Grinders
and Straight Screwdrivers



SM-705SH
3/8" Reversible Drill
- with Exhaust Hose Kit



EH-701SUB
Exhaust Hose Assembly (Optional)

▲ For Use on All Series Pistol Grip Drills
and Screwdrivers



SM-5B-6192PSH
4" Angle Grinder
- with Exhaust Hose Kit



EH-6192SUB
Exhaust Hose Assembly (Optional)

▲ For Use on All Series SM-5D-6192P
and SM-5D-6192A Series Tools

Comfort Grips



#82252-108
Comfort Grip

▲ For Use on
SM-751 Series Pistol Grip Drills
SM-822 / SM-8221 Series Pistol Grip
Screwdrivers

SM-751RG



SM-822RG



SM-8221RG



#81352-108
Comfort Grip



#81352-105
Comfort Grip

▲ For Use on
SM-725 Series Pistol Grip Drills
SM-812 Series Pistol Grip Screwdrivers

SM-725RG



SM-812RG



#80253-108
Comfort Grip



#80253-105
Comfort Grip



#80253-103
Comfort Grip

▲ For Use on
SM-701 Series Pistol Grip Drills
SM-802 Series Pistol Grip Screwdrivers
SM-751 Series Pistol Grip Drills
SM-822 Series Pistol Grip Screwdrivers
SM-8221 Series Pistol Grip Screwdrivers

SM-701RG



SM-802RG





SUNTECH
PNEUMATIC TOOLS



1/2" DRIVE



Vibro Impact Air Hammers & Kits

Accessories (Optional)



SA-0101S
Spring Retainer



G-118R
Quick Change Retainer

SM-108

Vibro Impact Air Hammer

- Shank Opening : 10.2 mm
- Round Shank

SM-108H

Vibro Impact Air Hammer

- Shank Opening : 10.2 mm
- Hex. Shank

SM-108H1

Vibro Impact Air Hammer

- Shank Opening : 11.1 mm
- Hex. Shank



Features:

- Dual Elastomer Cushions Absorb Shock and Vibration to Reduce User Fatigue
- Direct Multi-Port Front Exhaust Keeps Air and Debris Away from User
- High Grade Steel Barrel Provides Greater Strength
- Hardened Steel Piston Deliver Harder Blows for Maximum Impact

Vibration Damped



Kit Includes:

- 1 pc SM-108 Vibro Impact Air Hammer
- 5 pcs Chisel 7"
- 1 pc Quick Change Retainer
- 1 pc Spring Retainer
- 1 pc Blow Case

SM-108K

Vibro Impact Air Hammer Kit

- Shank Opening : 10.2 mm
- Round Shank

SM-108HK

Vibro Impact Air Hammer Kit

- Shank Opening : 10.2 mm
- Hex. Shank

SM-108H1K

Vibro Impact Air Hammer Kit

- Shank Opening : 11.1 mm
- Hex. Shank

Specifications:

Model No.	Bore Size	Blows Per Minute	Stroke Length Inch (mm)	Shank Opening Inch (mm)	Air Inlet (NPT)	Hose Size ID Inch (mm)	Air Consumption CFM (L/Min)	Length Inch (mm)	Weight Lbs (Kg)
SM-108	3/4"	2,500	2.9 (73)	0.401 (10.2)	1/4"	5/16 (8)	1.8 (51)	9.1 (232)	5.7 (2.6)
SM-108H	3/4"	2,500	2.9 (73)	0.401 (10.2)	1/4"	5/16 (8)	1.8 (51)	9.1 (232)	5.7 (2.6)
SM-108H1	3/4"	2,500	2.9 (73)	0.437 (11.1)	1/4"	5/16 (8)	1.8 (51)	9.1 (232)	5.7 (2.6)

* Recommended Air Pressure at 90 PSI (6.2 Bar)

Vibro Impact Air Hammer Kit

Features:

- Dual Elastomer Cushions Absorb Shock and Vibration to Reduce User Fatigue
- Direct Multi-Port Front Exhaust Keeps Air and Debris Away from User
- High Grade Steel Barrel Provides Greater Strength
- Hardened Steel Piston Deliver Harder Blows for Maximum Impact

SM-108K2

Vibro Impact Air Hammer Kit

- Shank Opening : 10.2 mm
- Round Shank

Kit Includes:

- 1 pc SM-108 Vibro Impact Air Hammer
- 4 pcs Special Vibro Chisel
- 1 pc Quick Change Retainer
- 1 pc Spring Retainer
- 1 pc Blow Case



Special Vibro Chisels



CRA-51036
Universal Joint Chisel



CRA-51038
Smoothing Hammer Chisel



CRA-51053
3/8" Drive Air Hammer
Socket Adapter



CRA-51056
1/2" Drive Air Hammer
Socket Adapter

Specifications :

Model No.	Bore Size	Blows Per Minute	Stroke Length Inch (mm)	Shank Opening Inch (mm)	Air Inlet (NPT)	Hose Size ID Inch (mm)	Air Consumption CFM (L/Min)	Length Inch (mm)	Weight Lbs (Kg)
SM-108	3/4"	2,500	2.9 (73)	0.401 (10.2)	1/4"	5/16 (8)	1.8 (51)	9.1 (232)	5.7 (2.6)

*Recommended Air Pressure at 90 PSI (6.2 Bar)

Features:

- Cylinder: Alloyed Steel, Heat-treated & Honed
- Piston: Alloyed Steel, Heat-treated & Ground
- Air Regulator for Speed Control
- for Heavy Duty Use



SM-103S

Short Barrel Hammer

- Shank Opening : 10.2 mm
- Round Shank

SM-103SH

Short Barrel Hammer

- Shank Opening : 10.2 mm
- Hex. Shank

SM-103SH1

Short Barrel Hammer

- Shank Opening : 11.1 mm
- Hex. Shank



SM-103

Long Barrel Hammer

- Shank Opening : 10.2 mm
- Round Shank

SM-103H

Long Barrel Hammer

- Shank Opening : 10.2 mm
- Hex. Shank

SM-103H1

Long Barrel Hammer

- Shank Opening : 11.1 mm
- Hex. Shank



Speed Control



SM-103K

Long Barrel Hammer Kit

- Shank Opening : 10.2 mm
- Round Shank

SM-103HK

Long Barrel Hammer Kit

- Shank Opening : 10.2 mm
- Hex. Shank

SM-103H1K

Long Barrel Hammer Kit

- Shank Opening : 11.1 mm
- Hex. Shank

Kit Includes:

- 1 pc Long Barrel Hammer
- 5 pcs Chisel 7"
- 1 pc Spring Retainer
- 1 pc Blow Case

Specifications:

Model No.	Blows Per Minute	Stroke length Inch (mm)	Shank Opening Inch (mm)	Air Inlet (NPT)	Hose Size Inch (mm)	Air Consumption CFM (L/Min)	Overall Length Inch (mm)	Weight Lbs (Kg)
SM-103	2,600	2.9 (73)	0.401 (10.2)	1/4"	3/8 (10)	4 (113)	8.3 (211)	4.8 (2.2)
SM-103H	2,600	2.9 (73)	0.401 (10.2)	1/4"	3/8 (10)	4 (113)	8.3 (211)	4.8 (2.2)
SM-103H1	2,600	2.9 (73)	0.437 (11.1)	1/4"	3/8 (10)	4 (113)	8.3 (211)	4.8 (2.2)
SM-103S	3,000	2.2 (56)	0.401 (10.2)	1/4"	3/8 (10)	4 (113)	6.9 (175)	4.2 (1.9)
SM-103SH	3,000	2.2 (56)	0.401 (10.2)	1/4"	3/8 (10)	4 (113)	6.9 (175)	4.2 (1.9)
SM-103SH1	3,000	2.2 (56)	0.437 (11.1)	1/4"	3/8 (10)	4 (113)	6.9 (175)	4.2 (1.9)

* Recommended Air Pressure at 90 PSI (6.2 Bar)

Chipping Hammer

Features:

- Easy to Handle - Good Weight Balance
- Least Vibration at Handle to Reduce Fatigue
- Precision Spool Valve Design System to Ensure Maximum Power Against Light Body Weight

SM-TH-1830
Air Chipping Hammer
- Hex. Shank



Vibration Damped

Accessories (Optional)



G-118R
Quick Change Retainer

Accessories (Optional)

- Chisel Length : 7" (180 mm)



#H1118006-11
Tail Pipe Cutter



#H1118013-11
Double Edge Cutter



#H1118002-11
Flat Chisel



#H1118003-11
Spot Weld Bracket



#H1118025-11
Shred Metal Trimmer

Specifications:

Model No.	Bore Size	Blows Per Minute	Stroke Length Inch (mm)	Shank Opening Inch (mm)	Air Inlet (NPT)	Hose Size ID Inch (mm)	Air Consumption CFM (L/Min)	Length Inch (mm)	Weight Lbs (Kg)
SM-TH-1830	18 mm	5,000	1.2 (30)	0.437 (11.1)	1/4"	3/8 (10)	3 (85)	7.7 (196)	5.1 (2.3)

* Recommended Air Pressure at 90 PSI (6.2 Bar)

Accessories (Optional)



G-102
Quick Change Retainer

SG-0101R

Short Air Hammer
- Round Shank



SG-0101H

Short Air Hammer
- Hex. Shank

SG-0102R

135mm Air Hammer
- Round Shank



SG-0102H

135mm Air Hammer
- Hex. Shank

SG-0204R

Medium Air Hammer
- Round Shank



SG-0204H

Medium Air Hammer
- Hex. Shank

SG-0304R

Long Air Hammer
- Round Shank



SG-0304H

Long Air Hammer
- Hex. Shank

SG-0204PSR

Medium Air Hammer Kit



In Blow Molded Case Complete with:

- 1 pc SG-0204R Medium Air Hammer (Round Shank)
- 5 pcs Chisel 5"
- 1 pc Oiler (Optional)
- 1 pc Blow Case

SG-0304PSR

Long Air Hammer Kit



In Blow Molded Case Complete with:

- 1 pc SG-0304R Long Air Hammer (Round Shank)
- 5 pcs Long Chisels 7"
- 1 pc Oiler (Optional)
- 1 pc Blow Case

Specifications :

Model No.	Bore Size	Blows Per Minute (BPM)	Stroke length Inch (mm)	Shank Opening Inch (mm)	Air Inlet (NPT)	Hose Size ID Inch (mm)	Air Consumption CFM (L/Min)	Overall Length Inch (mm)	Weight Lbs (Kg)
SG-0101R	3/4"	5,000	1.6 (41)	0.401 (10.2)	1/4"	3/8 (10)	4 (113)	5.7 (145)	3 (1.4)
SG-0101H	3/4"	5,000	1.6 (41)	0.401 (10.2)	1/4"	3/8 (10)	4 (113)	5.7 (145)	3 (1.4)
SG-0102R	3/4"	4,500	1.6 (41)	0.401 (10.2)	1/4"	3/8 (10)	4 (113)	5.8 (148)	3.3 (1.5)
SG-0102H	3/4"	4,500	1.6 (41)	0.401 (10.2)	1/4"	3/8 (10)	4 (113)	5.8 (148)	3.3 (1.5)
SG-0204R	3/4"	3,200	2.6 (67)	0.401 (10.2)	1/4"	3/8 (10)	4 (113)	7.4 (187)	3.5 (1.6)
SG-0204H	3/4"	3,200	2.6 (67)	0.401 (10.2)	1/4"	3/8 (10)	4 (113)	7.4 (187)	3.5 (1.6)
SG-0304R	3/4"	2,000	3.5 (89)	0.401 (10.2)	1/4"	3/8 (10)	4 (113)	8 (202)	4 (1.9)
SG-0304H	3/4"	2,000	3.5 (89)	0.401 (10.2)	1/4"	3/8 (10)	4 (113)	8 (202)	4 (1.9)

* Recommended Air Pressure at 90 PSI (6.2 Bar)

Hammers & Kits

SG-2711R

Heavy Duty Medium Hammer
- Round Shank



SG-2711H

Heavy Duty Medium Hammer
- Hex. Shank

SG-2715R

Heavy Duty Long Hammer
- Round Shank



SG-2715H

Heavy Duty Long Hammer
- Hex. Shank

SG-0218-2X

Riveting Hammer

SG-0218-3X

Riveting Hammer

SG-0218-4X

Riveting Hammer



SG-0218-5X

Riveting Hammer

SG-0218-7X

Riveting Hammer

SG-0218-9X

Riveting Hammer



SG-2711PSR

Heavy Duty Medium Hammer Kit



In Blow Molded Case Complete with:

- 1 pc SG-2711R Heavy Duty Medium Hammer
- 5 pcs Chisel 7"
- 1 pc Oiler (Optional)
- 1 pc Blow Case

SG-2715PSR

Heavy Duty Long Hammer Kit



In Blow Molded Case Complete with:

- 1 pc SG-2715R Heavy Duty Long Hammer
- 5 pcs Chisel 7"
- 1 pc Oiler (Optional)
- 1 pc Blow Case

Specifications:

Model No.	Bore Size	Blows Per Minute (BPM)	Stroke Length Inch (mm)	Shank Opening Inch (mm)	Air Inlet (NPT)	Hose Size ID Inch (mm)	Air Consumption CFM (L/Min)	Overall Length Inch (mm)	Weight Lbs (Kg)
SG-2711R	3/4"	3,000	2.2 (57)	0.401 (10.2)	1/4"	3/8 (10)	2.6 (73.6)	7.2 (184)	3.5 (1.6)
SG-2711H	3/4"	3,000	2.2 (57)	0.401 (10.2)	1/4"	3/8 (10)	2.6 (73.6)	7.2 (184)	3.5 (1.6)
SG-2715R	3/4"	2,500	3.4 (87)	0.401 (10.2)	1/4"	3/8 (10)	2.8 (79.2)	9.2 (233)	4.2 (1.9)
SG-2715H	3/4"	2,500	3.4 (87)	0.401 (10.2)	1/4"	3/8 (10)	2.8 (79.2)	9.2 (233)	4.2 (1.9)
SG-0218-2X	1/2"	2,580	2.2 (57)	0.401 (10.2)	1/4"	3/8 (10)	4 (113)	6 (152)	2.7 (1.2)
SG-0218-3X	1/2"	2,160	2.9 (73)	0.401 (10.2)	1/4"	3/8 (10)	4 (113)	6.9 (175)	2.9 (1.3)
SG-0218-4X	1/2"	2,300	3.1 (78)	0.401 (10.2)	1/4"	3/8 (10)	4 (113)	7.7 (196)	3.1 (1.4)
SG-0218-5X	3/4"	1,600	2.7 (68)	0.498 (12.6)	1/4"	3/8 (10)	6 (170)	8.1 (205)	4.8 (2.2)
SG-0218-7X	3/4"	1,140	3.9 (98)	0.498 (12.6)	1/4"	3/8 (10)	6 (170)	10.2 (258)	5.1 (2.3)
SG-0218-9X	3/4"	900	5.8 (148)	0.498 (12.6)	1/4"	3/8 (10)	6 (170)	11.1 (282)	5.7 (2.6)

* Recommended Air Pressure at 90 PSI (6.2 Bar)

Hammers

SM-102

Short Air Hammer
- Hex. Shank



SG-0123R

Mini Chipping Hammer
- Round Shank



(SG-0123H - Hex. Shank)

SG-0122R-1

1" Chipping Hammer
- Round Shank

(SG-0122H-1 - Hex. Shank : 0.580")

SG-0122R-3

3" Chipping Hammer
- Round Shank

(SG-0122H-3 - Hex. Shank : 0.580")

SG-0122R-2

2" Chipping Hammer
- Round Shank

(SG-0122H-2 - Hex. Shank : 0.580")

SG-0122R-4

4" Chipping Hammer
- Round Shank

(SG-0122H-4 - Hex. Shank : 0.580")



Specifications:

Model No.	Bore Size	Blows Per Minute (BPM)	Stroke length Inch (mm)	Shank Opening Inch (mm)	Air Inlet (NPT)	Hose Size ID Inch (mm)	Air Consumption CFM (L/Min)	Overall Length Inch (mm)	Weight Lbs (Kg)
SM-102	3/4"	5,000	1.6 (41)	0.437 (11.1)	1/4"	3/8 (10)	4 (113)	6.7 (169)	3.4 (1.5)
SG-0123R	25/32"	3,000	1.5 (38)	0.551 (14)	1/4"	3/8 (10)	4 (113)	10.9 (277)	5.1 (2.3)
SG-0122R-1	1-1/8"	2,100	1 (25.4)	0.680 (17.3)	3/8"	1/2 (12.7)	6 (170)	12.5 (318)	14.5 (6.6)
SG-0122R-2	1-1/8"	1,900	2 (50)	0.680 (17.3)	3/8"	1/2 (12.7)	7 (198)	13.3 (337)	15.2 (6.9)
SG-0122R-3	1-1/8"	1,700	3 (75)	0.680 (17.3)	3/8"	1/2 (12.7)	8 (226)	15.3 (388)	16 (7.3)
SG-0122R-4	1-1/8"	1,400	3.9 (100)	0.680 (17.3)	3/8"	1/2 (12.7)	8 (226)	16.5 (420)	18 (8.2)

* Recommended Air Pressure at 90 PSI (6.2 Bar)

Flux Chipper

SM-104

Flux Chipper
(Chisel not Included)



• Shank Size : 0.43" (10.9 mm)

Accessories (Optional)

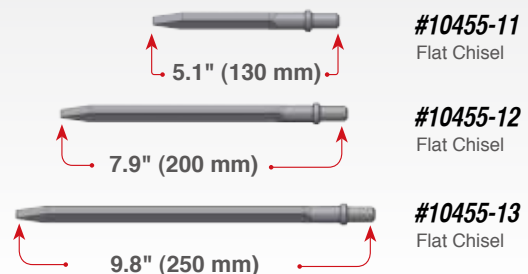

Specifications:

Model No.	Blows Per Min. (BPM)	Piston Size Dia Inch (mm)	Stroke Length Inch (mm)	Air Inlet (NPT)	Hose Size ID Inch (mm)	Air Consumption CFM (L/Min)	Length Inch (mm)	Weight Lbs (Kg)
SM-104	5,400	3/4 (20)	0.75 (19)	1/4"	3/8 (10)	1 (28.33)	6.9 (174)	1.78 (0.8)

* Recommended Air Pressure at 90 PSI (6.2 Bar)

Needle Scalers & Flux Chippers

SG-0315

Flux Chipper



SG-0315NS

Needle Scaler

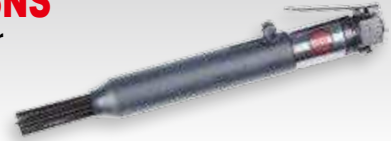

SG-2288

Flux Chipper



SG-2288NS

Needle Scaler



SG-9121

Flux Chipper



SG-9121NS

Needle Scaler



SG-2280

Needle Scaler



SG-2100NS

Needle Scaler



SG-2110NS

Needle Scaler



SG-2111NS

Needle Scaler

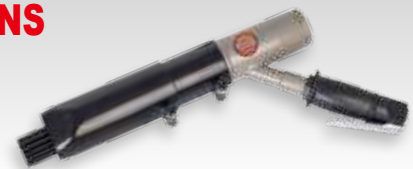

Specifications:

Model No.	Blows Per Min. (BPM)	Needle Dia. (mm)	Needle Per Tool (Pc)	Air Inlet (NPT)	Hose Size ID Inch (mm)	Air Consumption CFM (L/Min)	Overall Length Inch (mm)	Weight Lbs (Kg)
SG-0315	5,000	-	-	1/4"	3/8 (10)	7 (198)	13.1 (334)	4 (1.8)
SG-0315NS	4,600	3	19	1/4"	3/8 (10)	6 (170)	16.3 (414)	6 (2.7)
SG-2288	4,800	-	-	1/4"	3/8 (10)	2 (57)	8.5 (217)	2.4 (1.1)
SG-2288NS	5,000	3	12	1/4"	3/8 (10)	1.7 (48)	11.5 (291)	2.9 (1.3)
SG-9121	4,800	-	-	1/4"	3/8 (10)	8.5 (241)	14.2 (362)	4.6 (2.1)
SG-9121NS	4,600	3	19	1/4"	3/8 (10)	8.2 (232)	18 (458)	6.2 (2.8)
SG-2280	3,500	3 or 4	28 or 14	3/8"	3/8 (10)	7.4 (210)	13.3 (337)	7.9 (3.6)
SG-2100NS	3,700	2 or 3	29 or 19	1/4"	3/8 (10)	3 (85)	14.6 (370)	6.2 (2.8)
SG-2110NS	3,700	3	19	1/4"	3/8 (10)	3 (85)	13 (331)	6 (2.7)
SG-2111NS	2,500	2 or 3	66 or 49	1/4"	3/8 (10)	7.4 (210)	18 (457)	13.2 (6)

* Recommended Air Pressure at 90 PSI (6.2 Bar)

Needle Scaler & Scaling Hammer

SG-0204RNS

Needle Scaler



SG-2200

Scaling Hammer

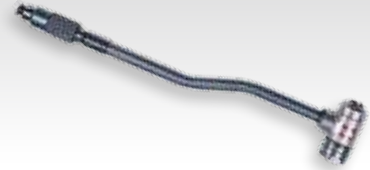

Specifications:

Model No.	Blows Per Min. (BPM)	Needle Dia. (mm)	Needle Per Tool (Pc)	Air Inlet (NPT)	Hose Size ID Inch (mm)	Air Consumption CFM (L/Min)	Overall Length Inch (mm)	Weight Lbs (Kg)
SG-0204RNS	3,200	3	19	1/4"	3/8 (10)	4 (113)	15.7 (400)	4.2 (2.2)
SG-2200	7,000	-	-	1/4"	3/8 (10)	4 (113)	22.3 (566)	4.8 (1.9)

* Recommended Air Pressure at 90 PSI (6.2 Bar)

Ratchet Wrenches

SM-30

3/8" Ratchet Wrench

SM-31

1/2" Ratchet Wrench



SM-33-3100

3/8" Stubby Ratchet Wrench



SM-32-3100

1/4" Stubby Ratchet Wrench



SG-0735

1/2" Heavy Duty Ratchet Wrench



Specifications:

Model No.	Free Speed (RPM)	Torque (Ft-lbs)	Square Drive	Air Inlet (NPT)	Hose Size ID Inch (mm)	Air Consumption CFM (L/Min)	Length Inch (mm)	Weight Lbs (Kg)
SM-30	200	50	3/8"	1/4"	3/8 (10)	4 (113)	10.4 (265)	2.5 (1.1)
SM-31	200	50	1/2"	1/4"	3/8 (10)	4 (113)	10.4 (265)	2.5 (1.1)
SM-33-3100	300	30	3/8"	1/4"	1/4 (6)	2.5 (62)	6.6 (168)	1.1 (0.5)
SM-32-3100	300	30	1/4"	1/4"	1/4 (6)	2.5 (62)	6.6 (168)	1.1 (0.5)
SG-0735	150	90	1/2"	1/4"	3/8 (10)	5 (142)	14.4 (365)	4.4 (2)

* Recommended Air Pressure at 90 PSI (6.2 Bar)

Ratchet Wrenches Kit

SM-31K

1/2" Ratchet Wrench Kit



In Blow Molded Case Complete with:

- 1 pc SM-31 1/2" Ratchet Wrench
- 7 pcs Sockets : 9, 11, 12, 13, 14, 17, 19 mm
- 1 pc 3" Extension Bar
- 1 pc Universal Joint
- 1 pc Screwdriver Extension Bar
- 3 pcs Screwdriver Bit
- 1 pc Screwdriver Adaptor
- 1 pc Blow Case

Impact Wrenches & Kit

SG-0775

3/8" Impact Wrench

▶ Single Hammer



SM-401

3/8" Butterfly Impact Wrench

▶ Single Hammer



SM-401A

3/8" Butterfly Impact Wrench

SM-4011A

1/2" Butterfly Impact Wrench



◀ with Grip

◀ Heavy-Duty

◀ Single Hammer

SM-401AK

3/8" Butterfly Impact Wrench Kit



In Blow Molded Case Complete with:

- 1 pc SM-401A 3/8" Butterfly Impact Wrench
- 7 pcs Socket : 8, 10, 11, 12, 13, 14, 17 & 19 mm
- 1 pc 3" Extension Bar
- 1 pc Bit Holder
- 1 pc Blow Mold Case

Specifications:

Model No.	Free Speed (RPM)	Anvil Size Inch (mm)	Maximum Torque Ft-lbs (Nm)	Working Torque Range Ft-lbs (Nm)	Air Inlet (NPT)	Hose Size ID Inch (mm)	Air Consumption CFM (L/Min)	Length Inch (mm)	Weight Lbs (Kg)
SG-0775	10,000	3/8 (10)	75 (101)	5~50 (7~68)	1/4"	3/8 (10)	3 (85)	5.3 (135)	2 (0.9)
SM-401	12,000	3/8 (10)	75 (101)	5~50 (7~68)	1/4"	3/8 (10)	3 (85)	5.9 (150)	2 (0.9)
SM-401A	10,000	3/8 (10)	75 (101)	5~50 (7~68)	1/4"	3/8 (10)	3 (85)	5.9 (150)	2 (0.9)
SM-4011A	10,000	1/2 (13)	75 (101)	5~50 (7~68)	1/4"	3/8 (10)	3 (85)	6.1 (156)	2 (0.9)

* Recommended Air Pressure at 90 PSI (6.2 Bar)

Impact Wrenches & Kit

SG-0717

1/2" Impact Wrench

SG-0717L

1/2" Impact Wrench
- with 2" Ext. Anvil

► Pin Clutch



SM-403

1/2" Impact Wrench

SM-403L

1/2" Impact Wrench
- with 2" Ext. Anvil

► Single Hammer



SG-0716

1/2" Impact Wrench

SG-0716L

1/2" Impact Wrench
- with 2" Ext. Anvil

► Pin Clutch



SG-0740

3/4" Impact Wrench

SG-0740L

3/4" Impact Wrench
- with 6" Ext. Anvil

► Single Hammer



SG-0750

3/4" Impact Wrench

SG-0750L

3/4" Impact Wrench
- with 6" Ext. Anvil

► Pin Clutch



SG-0751

3/4" Impact Wrench

SG-0751L

3/4" Impact Wrench
- with 6" Ext. Anvil

► Pin Clutch



SM-403K-17

1/2" Impact Wrench W/Socket Set



In Blow Molded Case Complete with:

- 1 pc SM-403 1/2" Impact Wrench
- 10 pcs Sockets : 9, 10, 11, 13, 14, 17, 19, 22, 24, 27 mm
- 1 pc 5" Extension Bar
- 1 pc Oil Pot
- 1 pc Mini Oiler
- 1 pc Hex. Wrench
- 1 pc Nipple
- 1 pc Blow Case

Specifications:

Model No.	Bolt Capacity	Free Speed (RPM)	Maximum Torque Ft-lbs (Nm)	Square Drive	Air Inlet (NPT)	Hose Size ID Inch (mm)	Average Air Consumption CFM (L/Min)	Length Inch (mm)	Weight Lbs (Kg)
SG-0717	5/8"	7,000	380 (513)	1/2"	1/4"	3/8 (10)	4.2 (119)	7.5 (191)	5.7 (2.6)
SG-0717L	5/8"	7,000	380 (513)	1/2"	1/4"	3/8 (10)	4.2 (119)	9.5 (241)	6.9 (3.1)
SM-403	5/8"	8,000	250 (339)	1/2"	1/4"	3/8 (10)	4 (113)	7.2 (182)	5.25 (2.4)
SM-403L	5/8"	8,000	250 (339)	1/2"	1/4"	3/8 (10)	4 (113)	8.3 (210)	6.25 (2.8)
SG-0716	5/8"	7,000	280 (378)	1/2"	1/4"	3/8 (10)	4 (113)	7.2 (184)	5.25 (2.4)
SG-0716L	5/8"	7,000	280 (378)	1/2"	1/4"	3/8 (10)	4 (113)	9.3 (235)	6.25 (2.8)
SG-0740	7/8"	4,500	500 (675)	3/4"	1/4"	3/8 (10)	7 (198)	9.6 (245)	10.6 (4.8)
SG-0740L	7/8"	4,500	500 (675)	3/4"	1/4"	3/8 (10)	7 (198)	15.5 (394)	11.6 (5.3)
SG-0750	1"	4,200	700 (945)	3/4"	1/4"	3/8 (10)	7 (198)	9.5 (241)	10.6 (4.8)
SG-0750L	1"	4,200	700 (945)	3/4"	1/4"	3/8 (10)	7 (198)	15.5 (394)	11.6 (5.3)
SG-0751	1"	4,800	700 (945)	3/4"	1/4"	3/8 (10)	7 (198)	9.8 (248)	11 (5)
SG-0751L	1"	4,800	700 (945)	3/4"	1/4"	3/8 (10)	7 (198)	15.7 (400)	11.6 (5.3)

* Recommended Air Pressure at 90 PSI (6.2 Bar)

Impact Wrenches

SG-0704S

1" Impact Wrench
- with 2" Ext. Anvil

SG-0704L

1" Impact Wrench
- with 6" Ext. Anvil



▲ Twin Hammer

SG-0705S

1" Impact Wrench
- with 2" Ext. Anvil

SG-0705L

1" Impact Wrench
- with 6" Ext. Anvil

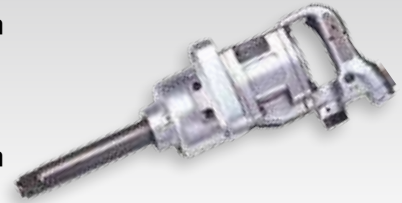

▲ Rocking Dog

SG-0706S

1" Impact Wrench
- with 2" Ext. Anvil

SG-0706L

1" Impact Wrench
- with 6" Ext. Anvil

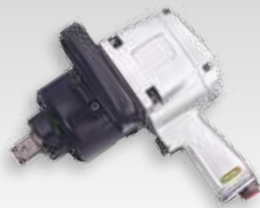

▲ Twin Hammer

SG-0707S

1" Impact Wrench
- with 2" Ext. Anvil

SG-0707L

1" Impact Wrench
- with 6" Ext. Anvil

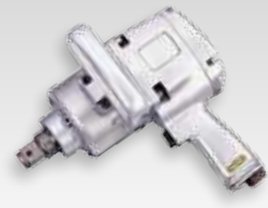

▲ Rocking Dog

SG-0708S

1" Impact Wrench
- with 2" Ext. Anvil

SG-0708L

1" Impact Wrench
- with 6" Ext. Anvil



▲ Rocking Dog

SG-0709S

1" Impact Wrench
- with 2" Ext. Anvil

SG-0709L

1" Impact Wrench
- with 6" Ext. Anvil



▲ Rocking Dog

Specifications:

Model No.	Bolt Capacity	Free Speed (RPM)	Maximum Torque Ft-lbs (Nm)	Square Drive	Air Inlet (NPT)	Hose Size ID Inch (mm)	Average Air Consumption CFM (L/Min)	Length Inch (mm)	Weight Lbs (Kg)
SG-0704S	1-3/4"	3,500	1,800 (2,430)	1"	1/2"	1/2 (13)	12 (340)	17 (432)	24.25 (11.1)
SG-0704L	1-3/4"	3,500	1,800 (2,430)	1"	1/2"	1/2 (13)	12 (340)	22.9 (581)	24.2 (11)
SG-0705S	1-1/2"	3,500	1,200 (1,620)	1"	1/2"	1/2 (13)	12 (340)	11.9 (302)	26.6 (12)
SG-0705L	1-1/2"	3,500	1,200 (1,620)	1"	1/2"	1/2 (13)	12 (340)	16.9 (429)	27.1 (12.3)
SG-0706S	1-3/4"	3,500	1,800 (2,430)	1"	1/2"	1/2 (13)	12 (340)	11.9 (302)	19.8 (9)
SG-0706L	1-3/4"	3,500	1,800 (2,430)	1"	1/2"	1/2 (13)	12 (340)	16.9 (429)	22.2 (10)
SG-0707S	1-1/2"	3,500	1,200 (1,620)	1"	1/2"	1/2 (13)	12 (340)	11.9 (302)	24.25 (11)
SG-0707L	1-1/2"	3,500	1,200 (1,620)	1"	1/2"	1/2 (13)	12 (340)	22.9 (581)	28.4 (13)
SG-0708S	1-1/4"	4,000	1,200 (1,620)	1"	1/2"	1/2 (13)	12 (340)	14.2 (361)	22.5 (10)
SG-0708L	1-1/4"	4,000	1,200 (1,620)	1"	1/2"	1/2 (13)	12 (340)	19.2 (488)	23.5 (10.7)
SG-0709S	1-1/4"	3,500	1,200 (1,620)	1"	1/2"	1/2 (13)	12 (340)	11.1 (282)	20.5 (9.3)
SG-0709L	1-1/4"	3,500	1,200 (1,620)	1"	1/2"	1/2 (13)	12 (340)	15.6 (397)	21.5 (9.8)

* Recommended Air Pressure at 90 PSI (6.2 Bar)

Impact Wrenches

SM-43-231F

- 1/2" Impact Wrench
- Twin Hammer
- Front Exhaust



SM-43-231FRG

- 1/2" Impact Wrench
- Twin Hammer
- Front Exhaust
- with Handle Grip



SM-43-231H

- 1/2" Impact Wrench
- Twin Hammer
- Handle Exhaust



SM-43-231HL

- 1/2" Impact Wrench
- Twin Hammer
- Handle Exhaust
- with 2" Ext. Anvil



SM-43-231HRG

- 1/2" Impact Wrench
- Twin Hammer
- Handle Exhaust
- with Handle Grip



SM-43-231HRGK3

- 1/2" Impact Wrench Kit



Kit Includes:

- 1 pc SM-43-231HRG 1/2" Impact Wrench - Twin Hammer
- 10 pcs Sockets set
incl : 9, 10, 11, 13, 14, 17, 19, 22, 24, 27 mm
- 1 pc Extension Bar
- 1 pc Universal Joint
- 1 pc Nipple
- 1 pc Blow Molded Case

SM-43-4137

- 1/2" Impact Wrench
- Twin Hammer
- Handle Exhaust



Air Regulator

(4 Different Speeds of Forward / Reverse)

Specifications :

Model No.	Free Speed (RPM)	Maximum Torque Ft-lbs (Nm)	Working Torque Range Ft-lbs (Nm)	Air Inlet (NPT)	Hose Size ID Inch (mm)	Average Air Consumption CFM (L/Min)	Square Drive Inch (mm)	Length Inch (mm)	Weight Lbs (Kg)
SM-43-231F	9000	680 (922)	25~400 (34~542)	1/4"	3/8 (10)	4.2 (119)	1/2"(12.7)	7.3 (185)	5.8 (2.63)
SM-43-231FRG	9000	680 (922)	25~400 (34~542)	1/4"	3/8 (10)	4.2 (119)	1/2"(12.7)	7.3 (185)	5.8 (2.63)
SM-43-231H	8000	680 (922)	25~400 (34~542)	1/4"	3/8 (10)	4.2 (119)	1/2"(12.7)	7.3 (185)	5.8 (2.63)
SM-43-231HL	8000	680 (922)	25~400 (34~542)	1/4"	3/8 (10)	4.2 (119)	1/2"(12.7)	9.3 (237)	6 (2.7)
SM-43-231HRG	8000	680 (922)	25~400 (34~542)	1/4"	3/8 (10)	4.2 (119)	1/2"(12.7)	7.3 (185)	5.8 (2.63)
SM-43-4137	8000	820 (1,112)	25~580 (34~787)	1/4"	3/8 (10)	4.2 (119)	1/2"(12.7)	8.1 (205)	6.6 (2.98)

* Recommended Air Pressure at 90 PSI (6.2 Bar)

SM-701

3/8" Air Drill (2,200 RPM)
- 2-Gears Type



SM-748

3/8" Air Drill (4,800 RPM)
- Full-Cage Gear Design



SM-705

3/8" Reversible Air Drill (2,000 RPM)



SM-706

3/8" Air Drill (2,600 RPM)
- 3-Gear Type



SM-703

1/2" Air Drill (500 RPM)



SM-704

1/2" Reversible Air Drill (800 RPM)



SM-734

1/2" Reversible Air Drill (400 RPM)



SM-709

3/8" Angle Drill (1,900 RPM)

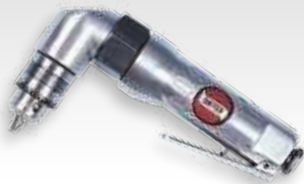

SM-709R

3/8" Reversible Angle Drill (1,600 RPM)



Specifications:

Model No.	Free Speed (RPM)	Chuck Size	Air Inlet (NPT)	Hose Size ID Inch (mm)	Air Consumption CFM (L/Min)	Spindle Thread	Length Inch (mm)	Weight Lbs (Kg)
SM-701	2,200	3/8"	1/4"	3/8 (10)	4 (113)	3/8"-24	7.1 (180)	2.5 (1.1)
SM-748	4,800	3/8"	1/4"	3/8 (10)	4 (113)	3/8"-24	7.1 (180)	2.5 (1.1)
SM-705	2,000	3/8"	1/4"	3/8 (10)	4 (113)	3/8"-24	7.2 (183)	2.5 (1.1)
SM-706	2,600	3/8"	1/4"	3/8 (10)	4 (113)	3/8"-24	7.2 (183)	2.5 (1.1)
SM-703	500	1/2"	1/4"	3/8 (10)	4 (113)	3/8"-24	8.9 (225)	3.3 (1.5)
SM-704	800	1/2"	1/4"	3/8 (10)	4 (113)	3/8"-24	8.3 (210)	3.1 (1.4)
SM-734	400	1/2"	1/4"	3/8 (10)	4 (113)	3/8"-24	8.7 (222)	3.6 (1.6)
SM-709	1,900	3/8"	1/4"	3/8 (10)	4 (113)	3/8"-24	7.6 (193)	2 (0.9)
SM-709R	1,600	3/8"	1/4"	3/8 (10)	4 (113)	3/8"-24	8.1 (205)	2.5 (1.1)

* Recommended Air Pressure at 90 PSI (6.2 Bar)

SM-728

1/4" Mini Air Drill (2,800 RPM)
- Full-Cage Gear Design



SM-720

3/8" Air Drill (2,600 RPM)
- Full-Cage Gear Design



SM-725

3/8" Reversible Drill (1,800 RPM)



SM-724

1/2" Reversible Drill (800 RPM)



SM-702

3/8" Air Drill (2,000 RPM)
- Full-Cage Gear Design



SM-712

1/2" Air Drill (400 RPM)
- Full-Cage Gear Design



SM-502

3/8" High Speed Drill (22,000 RPM)



SM-710

3/8" Straight Air Drill (2,600 RPM)

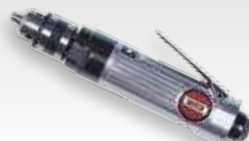

SM-746

3/8" Straight Air Drill (4,500 RPM)
- Full-Cage Gear Design



Specifications:

Model No.	Free Speed (RPM)	Chuck Size	Air Inlet (NPT)	Hose Size ID Inch (mm)	Air Consumption CFM (L/Min)	Spindle Thread	Length Inch (mm)	Weight Lbs (Kg)
SM-728	2,800	1/4"	1/4"	3/8 (10)	4 (113)	3/8"-24	5.2 (132)	1.3 (0.6)
SM-720	2,600	3/8"	1/4"	3/8 (10)	4 (113)	3/8"-24	7.9 (200)	2.6 (1.2)
SM-725	1,800	3/8"	1/4"	3/8 (10)	4 (113)	3/8"-24	7.3 (186)	2.5 (1.1)
SM-724	800	1/2"	1/4"	3/8 (10)	4 (113)	3/8"-24	8.3 (210)	3 (1.4)
SM-702	2,000	3/8"	1/4"	3/8 (10)	4 (113)	3/8"-24	6.9 (175)	2.6 (1.2)
SM-712	400	1/2"	1/4"	3/8 (10)	4 (113)	3/8"-24	8.4 (214)	3.5 (1.6)
SM-502	22,000	3/8"	1/4"	3/8 (10)	4 (113)	3/8"-24	7.8 (198)	1.7 (0.8)
SM-710	2,600	3/8"	1/4"	3/8 (10)	4 (113)	3/8"-24	8.3 (210)	2 (0.9)
SM-746	4,500	3/8"	1/4"	3/8 (10)	4 (113)	3/8"-24	8.1 (206)	2 (0.9)

* Recommended Air Pressure at 90 PSI (6.2 Bar)

Screwdrivers & Kit

SM-802

1/4" Air Screwdriver (1,800 RPM)
- Adjustable Clutch



SM-803

1/4" Air Screwdriver (800 RPM)
- Adjustable Clutch



SM-84-8020

1/4" Air Screwdriver (1,800 RPM)
- Positive Clutch



SM-806

1/4" Air Screwdriver (800 RPM)
- Positive Clutch



SM-832

1/4" Air Screwdriver (1,800 RPM)
- Positive Clutch



SM-833

1/4" Air Screwdriver (800 RPM)
- Positive Clutch



SM-802K

Air Screwdriver Kit



Kit Includes:

- 1 pc SM-802 1/4" Air Screwdriver
 - 7 pcs Bits
 - 1 pc Hex. Wrench
 - 1 pc Wrench
- Packed in a Carton Box.

Specifications:

Model No.	Free Speed (RPM)	Hex Drive Capacity (Inch)	Torque In-lbs (Nm)	Air Inlet (NPT)	Hose Size ID Inch (mm)	Air Consumption CFM (L/Min)	Length Inch (mm)	Weight Lbs (Kg)
SM-802	1,800	1/4	30-70 (3-8)	1/4"	3/8 (10)	4 (113)	8.1 (205)	2.4 (1.1)
SM-803	800	1/4	30-95 (3-11)	1/4"	3/8 (10)	4 (113)	8.9 (225)	2.9 (1.3)
SM-84-8020	1,800	1/4	115 (13)	1/4"	3/8 (10)	4 (113)	7.6 (192)	2.6 (1.2)
SM-806	800	1/4	145 (16)	1/4"	3/8 (10)	4 (113)	8 (203)	2.6 (1.2)
SM-832	1,800	1/4	115 (13)	1/4"	3/8 (10)	4 (113)	8.1 (205)	2.5 (1.1)
SM-833	800	1/4	145 (16)	1/4"	3/8 (10)	4 (113)	8.8 (223)	2.9 (1.3)

* Recommended Air Pressure at 90 PSI (6.2 Bar)

SM-812

1/4" Air Screwdriver (1,800 RPM)
- Adjustable Clutch

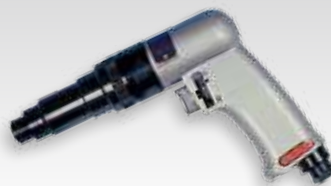

SM-813

1/4" Air Screwdriver (800 RPM)
- Adjustable Clutch



SM-84-8140

1/4" Air Screwdriver (1,800 RPM)
- Positive Clutch



SM-816

1/4" Air Screwdriver (800 RPM)
- Positive Clutch



SM-820

1/4" Air Screwdriver (2,000 RPM)
- Positive Clutch



SM-852

1/4" Air Screwdriver (1,800 RPM)
- Positive Clutch



SM-853

1/4" Air Screwdriver (800 RPM)
- Positive Clutch



Specifications:

Model No.	Free Speed (RPM)	Hex Drive Capacity (Inch)	Torque In-lbs (Nm)	Air Inlet (NPT)	Hose Size ID Inch (mm)	Air Consumption CFM (L/Min)	Length Inch (mm)	Weight Lbs (Kg)
SM-812	1,800	1/4	30-70 (3-8)	1/4"	3/8 (10)	4 (113)	8.3 (211)	2.6 (1.2)
SM-813	800	1/4	30-95 (3-11)	1/4"	3/8 (10)	4 (113)	9 (228)	2.9 (1.3)
SM-84-8140	1,800	1/4	115 (13)	1/4"	3/8 (10)	4 (113)	7.6 (194)	2.6 (1.2)
SM-816	800	1/4	145 (16)	1/4"	3/8 (10)	4 (113)	8.3 (212)	2.6 (1.2)
SM-820	2,000	1/4	115 (13)	1/4"	3/8 (10)	4 (113)	8 (203)	2.6 (1.2)
SM-852	1,800	1/4	115 (13)	1/4"	3/8 (10)	4 (113)	8 (204)	2.5 (1.1)
SM-853	800	1/4	145 (16)	1/4"	3/8 (10)	4 (113)	8.7 (222)	2.9 (1.3)

* Recommended Air Pressure at 90 PSI (6.2 Bar)

Straight Air Screwdrivers

SM-842

1/4" Air Screwdriver (1,800 RPM)
- Adjustable Clutch



SM-843

1/4" Air Screwdriver (800 RPM)
- Adjustable Clutch

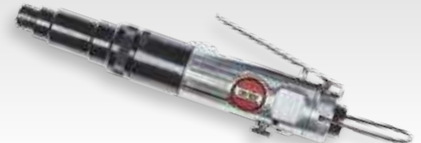

SM-844

1/4" Air Screwdriver (1,800 RPM)
- Positive Clutch



SM-846

1/4" Air Screwdriver (800 RPM)
- Positive Clutch



SM-862

1/4" Air Screwdriver (1,800 RPM)
- Positive Clutch



SM-863

1/4" Air Screwdriver (800 RPM)
- Positive Clutch

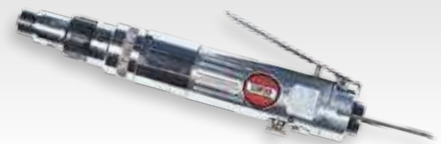

SG-0905

1/4" Air Screwdriver (8,000 RPM)
- Impact Type Clutch



SG-0909

1/4" Air Screwdriver (1,500 RPM)
- Adjustable Clutch



Specifications:

Model No.	Free Speed (RPM)	Hex Drive Capacity (Inch)	Torque In-lbs (Nm)	Air Inlet (NPT)	Hose Size ID Inch (mm)	Air Consumption CFM (L/Min)	Length Inch (mm)	Weight Lbs (Kg)
SM-842	1,800	1/4	30-70 (3-8)	1/4"	3/8 (10)	4 (113)	9.5 (242)	2.5 (1.1)
SM-843	800	1/4	30-95 (3-11)	1/4"	3/8 (10)	4 (113)	10.2 (260)	2.6 (1.2)
SM-844	1,800	1/4	115 (13)	1/4"	3/8 (10)	4 (113)	9.1 (230)	2.5 (1.1)
SM-846	800	1/4	145 (16)	1/4"	3/8 (10)	4 (113)	9.3 (236)	2.6 (1.2)
SM-862	1,800	1/4	45-115 (5-13)	1/4"	3/8 (10)	4 (113)	9.4 (240)	2.5 (1.1)
SM-863	800	1/4	45-145 (5-16)	1/4"	3/8 (10)	4 (113)	10.2 (258)	2.6 (1.2)
SG-0905	8,000	1/4	20-60 (2-7)	1/4"	3/8 (10)	4 (113)	7 (177)	1.5 (0.7)
SG-0909	1,500	1/4	10-30 (1-3)	1/4"	3/8 (10)	4 (113)	9.1 (231)	1.33 (0.6)

* Recommended Air Pressure at 90 PSI (6.2 Bar)

Air Screwdrivers

SM-872

1/4" Straight Air Screwdriver (1,800 RPM)
- External Adjustable Clutch



SM-873

1/4" Straight Air Screwdriver (800 RPM)
- External Adjustable Clutch



SM-882

1/4" Air Screwdriver (1,800 RPM)
- External Adjustable Clutch



SM-883

1/4" Air Screwdriver (800 RPM)
- External Adjustable Clutch



Specifications:

Model No.	Free Speed (RPM)	Hex Drive Capacity (Inch)	Torque In-lbs (Nm)	Air Inlet (NPT)	Hose Size ID Inch (mm)	Air Consumption CFM (L/Min)	Length Inch (mm)	Weight Lbs (Kg)
SM-872	1,800	1/4	45-115 (5-13)	1/4"	3/8 (10)	4 (113)	10.6 (268)	3 (1.4)
SM-873	800	1/4	45-145 (5-16)	1/4"	3/8 (10)	4 (113)	11.3 (288)	3.3 (1.5)
SM-882	1,800	1/4	45-115 (5-13)	1/4"	3/8 (10)	4 (113)	9.2 (234)	3 (1.4)
SM-883	800	1/4	45-145 (5-16)	1/4"	3/8 (10)	4 (113)	9.9 (252)	3.3 (1.5)

* Recommended Air Pressure at 90 PSI (6.2 Bar)

Stripping Tool & Tire Buffers

SM-645

Stripping Tool
- Full-Cage Gear Design

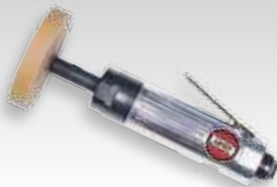

SM-661

Tire Buffer

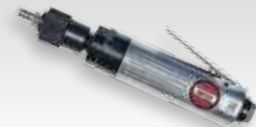

SM-662

Tire Buffer

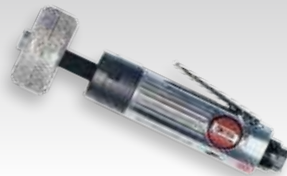

SM-747

Tire Buffer
- Full-Cage Gear Design



Specifications:

Model No.	Free Speed (RPM)	Pad Size (Inch)	Air Inlet (NPT)	Hose Size ID Inch (mm)	Air Consumption CFM (L/Min)	Length Inch (mm)	Weight Lbs (Kg)
SM-645	4,000	3-1/2"	1/4"	3/8 (10)	3 (85)	8.5 (217)	1.7 (0.8)
SM-661	2,600	-	1/4"	3/8 (10)	4 (113)	9.3 (237)	1.25 (0.5)
SM-662	2,600	-	1/4"	3/8 (10)	4 (113)	8.2 (208)	2 (0.9)
SM-747	4,500	-	1/4"	3/8 (10)	4 (113)	33 (838)	2.6 (1.2)

* Recommended Air Pressure at 90 PSI (6.2 Bar)

Family Looking Tools

SM-582

1/4" Die Grinder - Full Size



SM-582F

1/4" Extended Die Grinder



SM-585

1/4" Die Grinder



▲ Full-Cage Gear Design

SM-681

Air Tire Buffer



▲ 3-Gear Type

SM-682

Air Tire Buffer



SM-683

Air Tire Buffer



▲ Full-Cage Gear Design

SM-580

3/8" High Speed Straight Air Drill



SM-780

3/8" Straight Air Drill



SM-781

3/8" Straight Air Drill



▲ Full-Cage Gear Design

SM-786

3/8" Straight Air Drill



▲ Full-Cage Gear Design

SM-284S

Straight Air Shear



▲ Cutting Capacity Steel 1.2mm

SM-586

3" Cut-Off Tool

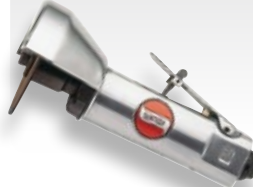

▲ Cutting Wheel : 3"

SM-586A

3" Cut-Off Tool



▲ Swivel Guard
▲ Cutting Wheel : 3"

Specifications:

Model No.	Free Speed (RPM)	Collet (or Chuck) Size Inch (mm)	Air Inlet (NPT)	Hose Size ID Inch (mm)	Air Consumption CFM (L/Min)	Length Inch (mm)	Weight Lbs (Kg)
SM-582	23,000	1/4 (6)	1/4"	3/8 (10)	4 (113)	6.7 (171)	1.3 (0.6)
SM-582F	23,000	1/4 (6)	1/4"	3/8 (10)	4 (113)	13 (330)	2.2 (1.0)
SM-585	4,500	1/4 (6)	1/4"	3/8 (10)	4 (113)	8.1 (206)	1.8 (0.8)
SM-681	2,600	-	1/4"	3/8 (10)	4 (113)	9.5 (241)	2.2 (1.0)
SM-682	2,600	-	1/4"	3/8 (10)	4 (113)	8.3 (210)	2.1 (0.95)
SM-683	2,600	-	1/4"	3/8 (10)	4 (113)	9.3 (235)	2.2 (1.0)
SM-580	22,000	3/8 (10)	1/4"	3/8 (10)	4 (113)	7.9 (200)	1.8 (0.8)
SM-780	2,600	3/8 (10)	1/4"	3/8 (10)	4 (113)	8.7 (222)	2.0 (0.9)
SM-781	2,600	3/8 (10)	1/4"	3/8 (10)	4 (113)	8.1 (205)	2.0 (0.9)
SM-786	4,500	3/8 (10)	1/4"	3/8 (10)	4 (113)	8.3 (210)	2.0 (0.9)
SM-284S	2,800	-	1/4"	3/8 (10)	4 (113)	10 (254)	2.5 (1.1)
SM-586	22,000	-	1/4"	3/8 (10)	4 (113)	7.4 (188)	1.8 (0.8)
SM-586A	22,000	-	1/4"	3/8 (10)	4 (113)	7.5 (191)	1.8 (0.8)

* Recommended Air Pressure at 90 PSI (6.2 Bar)

SM-512

1/4" Die Grinder



SM-532

1/4" Mini Die Grinder



SM-512K

1/4" Die Grinder Kit



Kit Includes:

- 1 pc SM-512 1/4" Die Grinder
- 1 pc 1/4"(6mm) Collet installed
- 1 pc Extra 1/8"(3mm) Collet
- 10 pcs Mounted Wheels
- 1 pc Blow Case

SM-532K

1/4" Mini Die Grinder Kit



Kit Includes:

- 1 pc SM-532 1/4" Mini Die Grinder
- 1 pc 1/4"(6mm) Collet installed
- 1 pc Extra 1/8"(3mm) Collet
- 10 pcs Mounted Wheels
- 1 pc Blow Case

SM-512F

1/4" Extended Die Grinder



SM-532E

1/4" Extended Mini Die Grinder

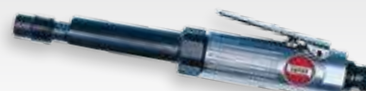

Specifications:

Model No.	Free Speed (RPM)	Collet Size Inch (mm)	Air Inlet (NPT)	Hose Size ID Inch (mm)	Air Consumption CFM (L/Min)	Length Inch (mm)	Weight Lbs (Kg)
SM-512	23,000	1/4 (6)	1/4"	3/8 (10)	4 (113)	6.8 (172)	1.3 (0.6)
SM-532	25,000	1/4 (6)	1/4"	3/8 (10)	4 (113)	6 (153)	0.8 (0.4)
SM-512F	23,000	1/4 (6)	1/4"	3/8 (10)	4 (113)	13.2 (335)	2.6 (1.2)
SM-532E	25,000	1/4 (6)	1/4"	3/8 (10)	4 (113)	9.7 (246)	1.3 (0.6)

* Recommended Air Pressure at 90 PSI (6.2 Bar)

Die Grinders & Cut-Off Tool

SM-522

1/4" Angle Die Grinder



SM-545

1/4" Hand Die Grinder



SM-562

1/4" Mini Angle Die Grinder
- Front Exhaust



SM-552

1/4" Mini Die Grinder
- Front Exhaust



▲ Full-Cage Gear Design

SM-542

1/4" Heavy Duty Mini Angle Die Grinder



SM-501C

1/4" Die Grinder
- Front Exhaust



SM-526

Cut-Off Tool
- Metal Guard



Features:

- **Compact, Lightweight Design**
- 90° Head for **Flexibility in Tight Spaces**
- For High-Speed Blending, Smoothing, Porting and Deburring
- 1/4" (6 mm) Collet

SM-562K

1/4" Mini Die Grinder Kit



Kit Includes:

- 1 pc SM-562 1/4" Mini Angle Die Grinder
- 1 pc 1/4" Collet (Installed)
- 1 pc 6 mm Collet
- 2 pcs 52227-11SUB Spanner Wrench
- 1 pc 2" Backing Pad (1/4"-20 Thread)
- 2 pcs 2" Coarse Surface Prep Pads
- 2 pcs 2" Med Surface Prep Pads
- 2 pcs 2" Fine Surface Prep Pads
- 2 pcs 2" #24 Grit Sanding Discs
- 2 pcs 2" #36 Grit Sanding Discs
- 2 pcs 2" #50 Grit Sanding Discs
- 1 pc Blow Case

Specifications:

Model No.	Free Speed (RPM)	Collet Size Inch (mm)	Air Inlet (NPT)	Hose Size ID Inch (mm)	Air Consumption CFM (L/Min)	Length Inch (mm)	Weight Lbs (Kg)
SM-522	22,000	1/4 (6)	1/4"	3/8 (10)	4 (113)	6.1 (155)	1.1 (0.5)
SM-545	4,500	1/4 (6)	1/4"	3/8 (10)	4 (113)	8 (203)	1.4 (0.6)
SM-562	22,000	1/4 (6)	1/4"	3/8 (10)	4 (113)	5 (126)	1 (0.4)
SM-552	25,000	1/4 (6)	1/4"	3/8 (10)	4 (113)	4.8 (121)	0.6 (0.3)
SM-542	20,000	1/4 (6)	1/4"	3/8 (10)	4 (113)	5.2 (133)	1.1 (0.5)
SM-501C	22,000	1/4 (6)	1/4"	3/8 (10)	4 (113)	6.9 (174)	1.1 (0.5)
SM-526	22,000	-	1/4"	3/8 (10)	4 (113)	7.4 (188)	1.8 (0.8)

* Recommended Air Pressure at 90 PSI (6.2 Bar)

Features:

- Lightweight for Easy Operation
- Piston Operation for Trouble Free Use
- Simple on/off Power
- Will Write on Materials up to 60Rc Hardness

SG-0573

Engraving Tool (3,800 BPM)
- Steel Housing



SG-0574

Engraving Tool (3,400 BPM)
- Plastic Housing



SG-0575

Engraving Tool (13,000 BPM)
- Steel Housing



Specifications:

Model No.	Blows Per Min. (BPM)	Air Inlet (NPT)	Hose Size ID Inch (mm)	Air Consumption CFM (L/Min)	Hose Length Inch (mm)	Length Inch (mm)	Weight Lbs (Kg)
SG-0573	3,800	1/4"	1/4 (6)	2 (57)	59 (1,500)	6.7 (171)	0.4 (0.2)
SG-0574	3,400	1/4"	1/4 (6)	2 (57)	59 (1,500)	6.7 (171)	0.4 (0.2)
SG-0575	13,000	1/4"	1/4 (6)	1.1 (31)	58 (1,480)	6.3 (159)	0.33 (0.15)

* Recommended Air Pressure at 90 PSI (6.2 Bar)

Micro Die Grinders

SG-0570

Micro Die Grinder (70,000 RPM)

SG-0582

Micro Die Grinder (82,000 RPM)



SG-0570A

Micro Angle Die Grinder (70,000 RPM)



Specifications:

Model No.	Free Speed (RPM)	Collet Size Inch (mm)	Air Inlet (NPT)	Hose Size ID Inch (mm)	Air Consumption CFM (L/Min)	Length Inch (mm)	Weight Lbs (Kg)
SG-0570	70,000	1/8 (3)	1/4"	1/4 (6)	1.5 (42.5)	5.5 (140)	0.4 (0.2)
SG-0582	82,000	1/8 (3)	1/4"	1/4 (6)	1.5 (42.5)	5.5 (140)	0.4 (0.2)
SG-0570A	70,000	1/8 (3)	1/4"	1/4 (6)	1.5 (42.5)	7.1 (181)	0.31 (0.14)

* Recommended Air Pressure at 90 PSI (6.2 Bar)

SM-516

Micro Die Grinder (56,000 RPM)



SM-516K

Micro Die Grinder Kit (56,000 RPM)

Kit Includes:

- 1 pc SM-516 Micro Die Grinder
- 1 pc 3 mm Collet Installed
- 10 pcs 3 mm Mounted Points
- 2 pcs Collet Wrench
- 1 pc Nipple
- 1 pc Blow Case



SM-516K-B

Micro Die Grinder Kit (56,000 RPM)

Kit Includes:

- 1 pc SM-516 Micro Die Grinder
- 1 pc 3 mm Collet Installed
- 5 pcs 3 mm Mounted Points
- 5 pcs 3 mm Carbide Burrs
- 2 pcs Collet Wrench
- 1 pc Nipple
- 1 pc Blow Case

Specifications:

Model No.	Free Speed (RPM)	Collet Size Inch (mm)	Air Inlet (NPT)	Hose Size ID Inch (mm)	Air Consumption CFM (L/Min)	Length Inch (mm)	Weight Lbs (Kg)
SM-516	56,000	1/8 (3)	1/4"	1/4 (6)	1.5 (42.5)	5.5 (140)	0.25 (0.1)

* Recommended Air Pressure at 90 PSI (6.2 Bar)

SG-0404

Dual Action Quiet Sander



SG-0420

Dual Action Sander



SG-0416

Jitterbug Sander



SG-0430

Straight Line Sander
- Dual Piston



SM-603-5

5" Random Orbital Sander
- Orbit Dia. 5 mm



SM-603V-5

5" Random Orbital Sander
- Orbit Dia. 5 mm



SM-603-6

6" Random Orbital Sander
- Orbit Dia. 5 mm

SM-603V-6

6" Random Orbital Sander
- Orbit Dia. 5 mm

▲ Dust Free Type

SG-0402

5" High Speed Sander



SM-660

5" High Speed Sander with Regulator



Specifications:

Model No.	Free Speed (RPM)	Pad Size (Inch)	Spindle Thread	Air Inlet (NPT)	Hose Size ID Inch (mm)	Air Consumption CFM (L/Min)	Length Inch (mm)	Weight Lbs (Kg)
SG-0404	10,000	6"	5/16"-24	1/4"	3/8 (10)	4 (113)	8.2 (209)	4.4 (2)
SG-0420	10,000	6"	5/16"-24	1/4"	3/8 (10)	4 (113)	8.9 (225)	3.8 (1.7)
SG-0416	8,000	3-2/3" x 6-1/2"	-	1/4"	3/8 (10)	4 (113)	7.1 (180)	4 (1.8)
SG-0430	3,000	2-1/2" x 15-3/4"	-	1/4"	3/8 (10)	4 (113)	15.8 (401)	6.25 (3.1)
SM-603-5	10,000	5"	5/16"-24	1/4"	3/8 (10)	18 (457)	5.5 (140)	3 (1.4)
SM-603-6	10,000	6"	5/16"-24	1/4"	3/8 (10)	18 (457)	5.5 (140)	4 (1.8)
SM-603V-5	10,000	5"	5/16"-24	1/4"	3/8 (10)	18 (457)	5.2 (133)	3 (1.4)
SM-603V-6	10,000	6"	5/16"-24	1/4"	3/8 (10)	18 (457)	5.2 (133)	4 (1.8)
SG-0402	18,000	3", 4-1/2", 5-1/2"	7/16"-20	1/4"	3/8 (10)	4 (113)	5.1 (130)	2.2 (1.0)
SM-660	14,000	3", 4-1/2", 5-1/2"	7/16"-20	1/4"	3/8 (10)	4 (113)	6.1 (155)	2 (0.9)

* Recommended Air Pressure at 90 PSI (6.2 Bar)

Air Riveters

SG-0250M

Air Rivet Nut Tool (M12)



SG-0250U

Air Rivet Nut Tool (1/2"-13 UNC)

SG-0300M

Air Rivet Nut Tool (M12)



SG-0300U

Air Rivet Nut Tool (1/2"-13 UNC)

SG-0810

Air Riveter (3/16")



SG-0811

Air Riveter (3/16")



SG-0814

Heavy Duty Air Riveter (1/4")



SG-0814M

Heavy Duty Air Riveter (1/4")



SG-0810K

Air Riveter Kit



Specifications:

Model No.	Blind Rivet Setting Capacity	Traction Power (Lbs)	Stroke Length (Inch)	Air Inlet (NPT)	Hose Size ID Inch (mm)	Length Inch (mm)	Weight Lbs (Kg)
SG-0250M	M12	4,800	1/4	1/4"	3/8 (10)	12.2 (310)	5.3 (2.4)
SG-0250U	1/2"-13 UNC	4,800	1/4	1/4"	3/8 (10)	12.2 (310)	5.3 (2.4)
SG-0300M	M12	6,000	1/4	1/4"	3/8 (10)	12.2 (310)	5.1 (2.3)
SG-0300U	1/2"-13 UNC	6,000	1/4	1/4"	3/8 (10)	12.2 (310)	5.1 (2.3)
SG-0810	3/16"	1,940	9/16	1/4"	3/8 (10)	10.6 (270)	4.4 (1.9)
SG-0811	3/16"	1,983	11/16	1/4"	3/8 (10)	11.8 (300)	3.3 (1.5)
SG-0814	1/4"	3,055	5/8	1/4"	3/8 (10)	11.8 (300)	4.6 (2)
SG-0814M	1/4"	3,099	5/8	1/4"	3/8 (10)	12.6 (320)	4.6 (2)

* Recommended Air Pressure at 90 PSI (6.2 Bar)

SG-0822

Air Body Saw



SA-24S

24 Teeth Saw Blade for SG-0822 (Optional)

SA-32S

32 Teeth Saw Blade for SG-0822 (Optional)

SG-0827

Air Body Saw & Filer



SG-0828

Air Body Saw

- with Exhaust Hose



SG-0829

Air Body Saw



SG-0829H

Air Body Saw

- with Exhaust Hose



SG-0831

Air Body Saw

- Composite
- Vibration Reduced



SG-0832

Air Pipe Saw

- Composite
- Vibration Reduced



SG-0833

Air Mini Body Saw



Specifications:

Model No.	Strokes Per Minute	Stroke Length (mm)	Air Inlet (NPT)	Hose Size ID Inch (mm)	Air Consumption CFM (L/Min)	Length Inch (mm)	Weight Lbs (Kg)
SG-0822	9,000	10	1/4"	3/8 (10)	4 (113)	9.3 (235)	1.2 (0.5)
SG-0827	8,000	10	1/4"	3/8 (10)	6 (150)	39.5 (1,003)	1.9 (0.7)
SG-0828	5,000	10	1/4"	3/8 (10)	4 (113)	9.8 (249)	2.4 (1.1)
SG-0829	9,000	10	1/4"	3/8 (10)	4 (113)	10.4 (263)	1.5 (0.7)
SG-0829H	9,000	10	1/4"	3/8 (10)	4 (113)	10.4 (263)	1.5 (0.7)
SG-0831	9,500	10	1/4"	3/8 (10)	3 (90)	11.8 (300)	1.1 (0.5)
SG-0832	5,000	25	1/4"	3/8 (10)	2.8 (80)	13.5 (343)	1.7 (0.8)
SG-0833	10,000	10	1/4"	3/8 (10)	2 (57)	8.2 (208)	1.0 (0.45)

* Recommended Air Pressure at 90 PSI (6.2 Bar)

Window Cut-Off Knives

SM-518 & SM-519

Auto Window Cut-Off Knife

Accessories (Optional):

- #51851 2-1/4" Blade (57mm)
- #51854 3-1/2" Blade (90mm)
- #51852 1-3/8" Short Blade (35mm)
- #51853 1-1/4" Curved Blade (30mm)
- #51860 5/16" Scraper Blade (8mm)
- #51861 1-3/8" Serrated Blade (35mm)
- #51862 1-3/8" Blade (35mm)
- #51855 3/4" Blade (18mm)
- #51857 1-1/2" Blade (36mm)
- #51858 2-1/2" Blade (63mm)
- #51859 3-1/2" Blade (90mm)



#51851
2-1/4" Blade (57mm)



#51854
3-1/2" Blade (90mm)



#51852
1-3/8" Short Blade (35mm)



#51853
1-1/4" Curved Blade (30mm)



#51860
5/16" Scraper Blade (8mm)



#51861
1-3/8" Serrated Blade (35mm)



#51862
1-3/8" Blade (35mm)

#51855
3/4" Blade (18mm)

#51858
2-1/2" Blade (63mm)

#51857
1-1/2" Blade (36mm)

#51859
3-1/2" Blade (90mm)



SM-518

Auto Window Cut-Off Knife



SM-519

Auto Window Cut-Off Knife

Specifications:

Model No.	Oscillation (Cycles) Per Min.	Stroke Arc.	Air Inlet (NPT)	Hose Size ID Inch (mm)	Air Consumption CFM (L/Min)	Length Inch (mm)	Weight Lbs (Kg)
SM-518	20,000	3 °	1/4"	3/8 (10)	4 (113)	7.9 (200)	2.25 (1)
SM-519	20,000	3 °	1/4"	3/8 (10)	4 (113)	8.2 (208)	2.7 (1.2)

* Recommended Air Pressure at 90 PSI (6.2 Bar)

Punches

SG-0692

Air Punch / Flange Tool - 5mm

SG-0693

Air Punch / Flange Tool - 8mm



Specifications:

Model No.	Capacity Steel (mm)	Punch (mm)	Flange Width (mm)	Hose Size ID Inch (mm)	Air Consumption CFM (L/Min)	Length Inch (mm)	Weight Lbs (Kg)
SG-0692	0.8-1.4	5	12	3/8 (10)	4 (113)	10 (254)	2.9 (1.3)
SG-0693	0.8-1.4	8	12	3/8 (10)	4 (113)	10 (254)	3.1 (1.4)

* Recommended Air Pressure at 90 PSI (6.2 Bar)

Scraper

SG-0815

Air Scraper



Specifications:

Model No.	Bore Diameter (mm)	Blows Per Min. (BPM)	Stroke Length (mm)	Hose Size ID Inch (mm)	Air Consumption CFM (L/Min)	Length Inch (mm)	Weight Lbs (Kg)
SG-0815	12.7	4,500	57	3/8 (10)	4.5 (115)	9.8 (248)	1.5 (0.7)

* Recommended Air Pressure at 90 PSI (6.2 Bar)

Spray Guns

SG-1042

Air Spray Gun



SG-1043

Air Spray Gun



SG-1046

Air Spray Gun



SG-1047

Air Spray Gun



SG-1048

Air Spray Gun



Specifications:

Model No.	Fluid Tip Size (I.D.) (mm)	Nozzle Size (mm)	Cup Capacity	Fluid Inlet	Air Inlet (NPT)	Air Pressure (PSI)	Air Consumption CFM (L/Min)	Height Inch (mm)	Weight Lbs (Kg)	Type
SG-1042	Ø 1.5	Ø 1.5, Ø 2.0 & Ø 2.5	0.3L	1/4"	1/4"	50-70	8 (226)	11 (279)	2 (0.9)	Gravity
SG-1043	Ø 1.5	Ø 1.5, Ø 2.0 & Ø 2.5	1L	3/8"	1/4"	50-70	8 (226)	11.2 (284)	2 (0.9)	Suction
SG-1046	Ø 1.6	Ø 1.5, Ø 1.6, Ø 1.8 & Ø 2.0	1L	3/8"	1/4"	50-70	8 (226)	11.5 (292)	2.3 (1)	Suction
SG-1047	Ø 0.8	Ø 0.5, Ø 0.8 & Ø 1.5	0.25L	M14 x 1.0	1/4"	35	4.5 (127)	12.8 (325)	0.7 (0.3)	Gravity
SG-1048	Ø 1.4	Ø 1.4, Ø 1.7 & Ø 2.0	0.6L	M16 x 1.5	1/4"	50-70	8.8-11.3 (249-320)	9.5 (241)	1.6 (0.7)	Gravity

* Recommended Air Pressure at 90 PSI (6.2 Bar)

Filer / Shears / Nibbler

SG-0825

Air Filer



Accessories (Optional):



SA-0825S

4 pcs File Set

Specifications:

Model No.	Stroke Speed (cycles/Min.)	Max. Shank Dia. Of Points	Stroke Length (mm)	Hose Size ID Inch (mm)	Air Consumption CFM (L/Min)	Length Inch (mm)	Weight Lbs (Kg)
SG-0825	3,700	1/4"	9	3/8 (10)	8.5 (216)	7.1 (180)	2.2 (1)

* Recommended Air Pressure at 90 PSI (6.2 Bar)

SM-204S

Straight Air Shear

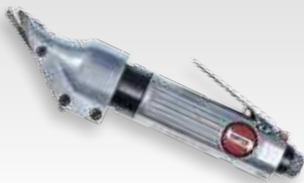

SM-204RG

Air Shear



SM-204

Air Shear



Specifications:

Model No.	Free Speed (RPM)	Cutting Capacity Steel (Gauge)	Air Inlet (NPT)	Hose Size ID Inch (mm)	Air Consumption CFM (L/Min)	Length Inch (mm)	Weight Lbs (Kg)
SM-204S	2,800	18	1/4"	3/8 (10)	4 (113)	10.1 (256)	2.2 (1)
SM-204RG	2,800	18	1/4"	3/8 (10)	4 (113)	9.1 (230)	2.9 (1.3)
SM-204	2,800	18	1/4"	3/8 (10)	4 (113)	9.1 (230)	2.9 (1.3)

* Recommended Air Pressure at 90 PSI (6.2 Bar)

SM-213

Air Nibbler
- Pull Type



Specifications:

Model No.	Capacity Steel (mm)	Cutting Speed (MPM)	Air Inlet (NPT)	Hose Size ID Inch (mm)	Air Consumption CFM (L/Min)	Length Inch (mm)	Weight Lbs (Kg)
SM-213	1.2	2.6	1/4"	3/8 (10)	4 (113)	6.9 (176)	2 (0.9)

* Recommended Air Pressure at 90 PSI (6.2 Bar)

Double Suction Cups & Kits

Features:

- Double Suction Pads for Secure Grip.
- Standard With Ratchet Tie Down for One Person Auto Glass Repair.
- Can Be Used on Glass, Plastic, Appliance, Steel, Alumium, etc.
- Each Double Pad Handle Can Lift Approximatly 240 Lbs.

SM-911

Double Suction Cup
- Plastic Cup



SM-911K

Double Suction Cup Kit with Strap
- Plastic Cup

SM-911KNH

Double Suction Cup Kit without Strap
- Plastic Cup



SM-9111

Double Suction Cup
- Big Plastic Cup



SM-9111K

Double Suction Cup Kit with Strap
- Big Plastic Cup



Two Way Gun & Kit

SG-1222

Two Way Gun



SG-1222K

Two Way Gun Kit



Kit Includes:

- 1 pc SG-1222 Two Way Gun
- 1 pc Small Bore Vacuum Tube
- 1 pc Brush
- 1 pc Flat Tube



Other Tools & Accessories

SG-9907

Air Caulking Gun



- ▶ Capacity of Cartridge : 310 ml
- ▶ Recommended Air Pressure at 65 PSI (4.5 Bar)

SG-025

Mini Grease Gun



- ▶ Capacity Bulk 80 cc
- ▶ Working Pressure 1000 PSI
- ▶ Chrome Plated Finish for Long Service Life



SG-1072-1

1" Air Duster (25mm)



SG-1072-4

4" Air Duster (130mm)

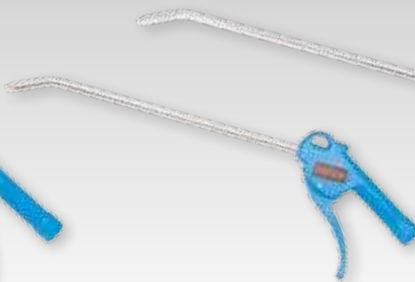

SG-1072-10

10" Air Duster (250mm)



SG-1072-20

20" Air Duster (500mm)



SG-9052

1/4" Air Regulator (Brass)



#61558-21

1/4" Air Regulator (Aluminum)



G-301

Mini Oiler



SA-12

Universal Air Connectors - 1/2" NPT

SA-14

Universal Air Connectors - 1/4" NPT

SA-38

Universal Air Connectors - 3/8" NPT



SA-225

Nylon Air Recoil Hoses (Swivel Head) - 1/4" NPT x 25'

SA-250

Nylon Air Recoil Hoses (Swivel Head) - 1/4" NPT x 50'

SA-325

Nylon Air Recoil Hoses (Swivel Head) - 3/8" NPT x 25'

SA-350

Nylon Air Recoil Hoses (Swivel Head) - 3/8" NPT x 50'



SA-225PU

1/4" P.U. Air Recoil Hoses (Swivel Head)
- 5mm(ID) x 8mm(OD) x 7.5m

SA-250PU

1/4" P.U. Air Recoil Hoses (Swivel Head)
- 5mm(ID) x 8mm(OD) x 15m

SA-325PU

1/4" P.U. Air Recoil Hoses (Swivel Head)
- 6.5mm(ID) x 9.5mm(OD) x 7.5m

SA-350PU

1/4" P.U. Air Recoil Hoses (Swivel Head)
- 6.5mm(ID) x 9.5mm(OD) x 15m

SA-430PU

1/4" P.U. Air Recoil Hoses (Swivel Head)
- 8mm(ID) x 12mm(OD) x 9m

SA-450PU

1/4" P.U. Air Recoil Hoses (Swivel Head)
- 8mm(ID) x 12mm(OD) x 15m

Tool Index

Model No.	Description	
<i>SG-0101H</i>	Short Air Hammer - Hex. Shank	168
<i>SG-0101R</i>	Short Air Hammer - Round Shank	168
<i>SG-0102H</i>	135mm Air Hammer - Hex. Shank	168
<i>SG-0102R</i>	135mm Air Hammer - Round Shank	168
<i>SG-0122H-1</i>	1" Chipping Hammer - Hex. Shank	170
<i>SG-0122H-2</i>	2" Chipping Hammer - Hex. Shank	170
<i>SG-0122H-3</i>	3" Chipping Hammer - Hex. Shank	170
<i>SG-0122H-4</i>	4" Chipping Hammer - Hex. Shank	170
<i>SG-0122R-1</i>	1" Chipping Hammer - Round Shank	170
<i>SG-0122R-2</i>	2" Chipping Hammer - Round Shank	170
<i>SG-0122R-3</i>	3" Chipping Hammer - Round Shank	170
<i>SG-0122R-4</i>	4" Chipping Hammer - Round Shank	170
<i>SG-0123H</i>	Mini Chipping Hammer - Hex. Shank	170
<i>SG-0123R</i>	Mini Chipping Hammer - Round Shank	170
<i>SG-0204H</i>	Medium Air Hammer - Hex. Shank	168
<i>SG-0204PSR</i>	Medium Air Hammer Kit - Round Shank	168
<i>SG-0204R</i>	Medium Air Hammer - Round Shank	168
<i>SG-0204RNS</i>	Needle Scaler	172
<i>SG-0218-2X</i>	Riveting Hammer	169
<i>SG-0218-3X</i>	Riveting Hammer	169
<i>SG-0218-4X</i>	Riveting Hammer	169
<i>SG-0218-5X</i>	Riveting Hammer	169
<i>SG-0218-7X</i>	Riveting Hammer	169
<i>SG-0218-9X</i>	Riveting Hammer	169
<i>SG-025</i>	Mini Grease Gun	195
<i>SG-0250M</i>	Air Rivet Nut Tool (M12)	189
<i>SG-0250U</i>	Air Rivet Nut Tool (1/2"-13 UNC)	189
<i>SG-0300M</i>	Air Rivet Nut Tool (M12)	189
<i>SG-0300U</i>	Air Rivet Nut Tool (1/2"-13 UNC)	189
<i>SG-0304H</i>	Long Air Hammer	168
<i>SG-0304PSR</i>	Long Air Hammer Kit	168
<i>SG-0304R</i>	Long Air Hammer	168
<i>SG-0315</i>	Flux Chipper	171
<i>SG-0315NS</i>	Needle Scaler	171
<i>SG-0402</i>	5" High Speed Sander	188
<i>SG-0404</i>	Dual Action Quiet Sander	188
<i>SG-0416</i>	Jitterbug Sander	188
<i>SG-0420</i>	Dual Action Sander	188
<i>SG-0430</i>	Straight Line Sander	188
<i>SG-0570</i>	Micro Die Grinder (70,000 RPM)	186
<i>SG-0570A</i>	Micro Angle Die Grinder (70,000 RPM)	186
<i>SG-0573</i>	Engraving Tool (3,800 BPM)	186
<i>SG-0574</i>	Engraving Tool (3,400 BPM)	186
<i>SG-0575</i>	Engraving Tool (13,000 BPM)	186
<i>SG-0582</i>	Micro Die Grinder (82,000 RPM)	186
<i>SG-0692</i>	Air Punch / Flange Tool - 5mm	191
<i>SG-0693</i>	Air Punch / Flange Tool - 8mm	191
<i>SG-0704L</i>	1" Impact Wrench	175
<i>SG-0704S</i>	1" Impact Wrench	175
<i>SG-0705L</i>	1" Impact Wrench	175
<i>SG-0705S</i>	1" Impact Wrench	175
<i>SG-0706L</i>	1" Impact Wrench	175
<i>SG-0706S</i>	1" Impact Wrench	175
<i>SG-0707L</i>	1" Impact Wrench	175
<i>SG-0707S</i>	1" Impact Wrench	175
<i>SG-0708L</i>	1" Impact Wrench	175
<i>SG-0708S</i>	1" Impact Wrench	175
<i>SG-0709L</i>	1" Impact Wrench	175

Model No.	Description	
<i>SG-0709S</i>	1" Impact Wrench	175
<i>SG-0716</i>	1/2" Impact Wrench	174
<i>SG-0716L</i>	1/2" Impact Wrench	174
<i>SG-0717</i>	1/2" Impact Wrench	174
<i>SG-0717L</i>	1/2" Impact Wrench	174
<i>SG-0735</i>	1/2" Heavy Duty Ratchet Wrench	172
<i>SG-0740</i>	3/4" Impact Wrench	174
<i>SG-0740L</i>	3/4" Impact Wrench	174
<i>SG-0750</i>	3/4" Impact Wrench	174
<i>SG-0750L</i>	3/4" Impact Wrench	174
<i>SG-0751</i>	3/4" Impact Wrench	174
<i>SG-0751L</i>	3/4" Impact Wrench	174
<i>SG-0775</i>	3/8" Impact Wrench	173
<i>SG-0810</i>	Air Riveter (3/16")	189
<i>SG-0810K</i>	Air Riveter Kit	189
<i>SG-0811</i>	Air Riveter (3/16")	189
<i>SG-0814</i>	Heavy Duty Air Riveter (1/4")	189
<i>SG-0814M</i>	Heavy Duty Air Riveter (1/4")	189
<i>SG-0815</i>	Air Scraper	192
<i>SG-0822</i>	Air Body Saw	190
<i>SG-0825</i>	Air Filer	193
<i>SG-0827</i>	Air Body Saw & Filer	190
<i>SG-0828</i>	Air Body Saw	190
<i>SG-0829</i>	Air Body Saw	190
<i>SG-0829H</i>	Air Body Saw	190
<i>SG-0831</i>	Air Body Saw	190
<i>SG-0832</i>	Air Pipe Saw	190
<i>SG-0833</i>	Air Mini Body Saw	190
<i>SG-0905</i>	1/4" Air Screwdriver (8,000 RPM)	181
<i>SG-0909</i>	1/4" Air Screwdriver (1,500 RPM)	181
<i>SG-1042</i>	Air Spray Gun	192
<i>SG-1043</i>	Air Spray Gun	192
<i>SG-1046</i>	Air Spray Gun	192
<i>SG-1047</i>	Air Spray Gun	192
<i>SG-1048</i>	Air Spray Gun	192
<i>SG-1072-1</i>	1" Air Duster (25mm)	195
<i>SG-1072-10</i>	10" Air Duster (250mm)	195
<i>SG-1072-20</i>	20" Air Duster (500mm)	195
<i>SG-1072-4</i>	4" Air Duster (130mm)	195
<i>SG-1222</i>	Two Way Gun	194
<i>SG-1222K</i>	Two Way Gun Kit	194
<i>SG-2100NS</i>	Needle Scaler	171
<i>SG-2110NS</i>	Needle Scaler	171
<i>SG-2111NS</i>	Needle Scaler	171
<i>SG-2200</i>	Scaling Hammer	172
<i>SG-2280</i>	Needle Scaler	171
<i>SG-2288</i>	Flux Chipper	171
<i>SG-2288NS</i>	Needle Scaler	171
<i>SG-2711H</i>	Heavy Duty Medium Hammer	169
<i>SG-2711PSR</i>	Heavy Duty Medium Hammer Kit	169
<i>SG-2711R</i>	Heavy Duty Medium Hammer	169
<i>SG-2715H</i>	Heavy Duty Long Hammer	169
<i>SG-2715PSR</i>	Heavy Duty Long Hammer Kit	169
<i>SG-2715R</i>	Heavy Duty Long Hammer	169
<i>SG-9052</i>	1/4" Air Regulator (Brass)	195
<i>SG-9121</i>	Flux Chipper	171
<i>SG-9121NS</i>	Needle Scaler	171
<i>SG-9907</i>	Air Caulking Gun	195

Tool Index

Model No.	Description	
<i>SK-43-4031PM-17-1</i>	Deep Socket: 17 mm	11
<i>SK-43-4031PM-17-2</i>	Socket: 17 mm	11
<i>SK-43-4031PM-19-1</i>	Deep Socket: 19 mm	11
<i>SK-43-4031PM-19-2</i>	Socket: 19 mm	11
<i>SK-43-4031PM-21-1</i>	Deep Socket: 21 mm	11
<i>SK-43-4031PM-21-2</i>	Socket: 21 mm	11
<i>SM-0915</i>	Suspending Stand	33
<i>SM-10-1001</i>	Scribe / Engraving Chisel	156
<i>SM-10-1001K</i>	Scribe / Engraving Chisel Kit	156
<i>SM-102</i>	Short Air Hammer	170
<i>SM-103</i>	Long Barrel Hammer	166
<i>SM-103H</i>	LONG Barrel Hammer - Hex. Shank	166
<i>SM-103H1</i>	Long Barrel Hammer - Hex. Shank	166
<i>SM-103H1K</i>	Long Barrel Hammer Kit - Hex. Shank	166
<i>SM-103HK</i>	LONG Barrel Hammer Kit - Hex. Shank	166
<i>SM-103K</i>	Long Barrel Hammer Kit - Round Shank	166
<i>SM-103S</i>	Short Barrel Hammer - Round Shank	166
<i>SM-103SH</i>	Short Barrel Hammer - Hex. Shank	166
<i>SM-103SH1</i>	Short Barrel Hammer - Hex. Shank	166
<i>SM-104</i>	Flux Chipper	170
<i>SM-108</i>	Super-Duty Air Hammer - Round Shank	164
<i>SM-108H</i>	Super-Duty Air Hammer - Hex. Shank	164
<i>SM-108H1</i>	Super-Duty Air Hammer - Hex. Shank	164
<i>SM-108H1K</i>	Super-Duty Air Hammer Kit - Hex. Shank	164
<i>SM-108HK</i>	Super-Duty Air Hammer Kit - Hex. Shank	164
<i>SM-108K</i>	Super-Duty Air Hammer Kit - Round Shank	164
<i>SM-108K2</i>	Vibro Impact Air Hammer Kit - Round Shank	165
<i>SM-1522</i>	Suspending Stand	33
<i>SM-204</i>	Air Shear	193
<i>SM-204RG</i>	Air Shear	193
<i>SM-204S</i>	Straight Air Shear	193
<i>SM-205</i>	Air Trimmer	109
<i>SM-213</i>	Air Nibbler	193
<i>SM-284S</i>	Straight Air Shear	183
<i>SM-28-7063</i>	Air Metal Shear	145
<i>SM-29-3011B</i>	Straight Air Shear	54
<i>SM-29-3011X</i>	Straight Air Shear	55
<i>SM-29-3011Y</i>	Straight Air Shear	56
<i>SM-29-3011Z</i>	Straight Air Shear	57
<i>SM-2945</i>	Air Metal Shear	145
<i>SM-29-5100</i>	Straight Air Shear	47
<i>SM-30</i>	3/8" Ratchet Wrench	172
<i>SM-31</i>	1/2" Ratchet Wrench	172
<i>SM-31K</i>	1/2" Ratchet Wrench Kit	173
<i>SM-32-3012</i>	1/4" Baby Ratchet Wrench	39
<i>SM-32-3014</i>	1/4" Mini Ratchet Wrench	39
<i>SM-32-3015</i>	1/4" Stubby Ratchet Wrench	36
<i>SM-32-3016</i>	Multi-Function Ratchet Wrench	37
<i>SM-32-3016K</i>	Multi-Function Ratchet Wrench Kit	37
<i>SM-32-3016K2</i>	Multi-Function Ratchet Wrench Kit	37
<i>SM-32-3022</i>	1/4" Baby Ratchet Wrench	38
<i>SM-32-3024</i>	1/4" Mini Ratchet Wrench	38
<i>SM-32-3100</i>	1/4" Stubby Ratchet Wrench	172
<i>SM-32-3124A</i>	1/4" Mini Ratchet Wrench	35
<i>SM-33-3012</i>	3/8" Baby Ratchet Wrench	39
<i>SM-33-3013</i>	3/8" Air Ratchet Wrench	39
<i>SM-33-3014</i>	3/8" Mini Ratchet Wrench	39
<i>SM-33-3015</i>	3/8" Stubby Ratchet Wrench	36

Model No.	Description	
<i>SM-33-3022</i>	3/8" Baby Ratchet Wrench	38
<i>SM-33-3023</i>	3/8" Air Ratchet Wrench	38
<i>SM-33-3023K</i>	3/8" Air Ratchet Wrench Kit	38
<i>SM-33-3024</i>	3/8" Mini Ratchet Wrench	38
<i>SM-33-3100</i>	3/8" Stubby Ratchet Wrench	172
<i>SM-33-3117</i>	3/8" Impact Ratchet Wrench	36
<i>SM-33-3117A</i>	3/8" Impact Ratchet Wrench	35
<i>SM-33-3123A</i>	3/8" Air Ratchet Wrench	35
<i>SM-33-3124A</i>	3/8" Mini Ratchet Wrench	35
<i>SM-34-3013</i>	1/2" Air Ratchet Wrench	39
<i>SM-34-3023</i>	1/2" Air Ratchet Wrench	38
<i>SM-34-3023K</i>	1/2" Air Ratchet Wrench Kit	38
<i>SM-34-3117</i>	1/2" Impact Ratchet Wrench	36
<i>SM-34-3117A</i>	1/2" Impact Ratchet Wrench	35
<i>SM-34-3123A</i>	1/2" Air Ratchet Wrench	35
<i>SM-401</i>	3/8" Butterfly Impact Wrench	173
<i>SM-4011A</i>	1/2" Butterfly Impact Wrench	173
<i>SM-401A</i>	3/8" Butterfly Impact Wrench	173
<i>SM-401AK</i>	3/8" Butterfly Impact Wrench Kit	173
<i>SM-403</i>	1/2" Impact Wrench	174
<i>SM-403K-17</i>	1/2" Impact Wrench W/Socket Set	174
<i>SM-403L</i>	1/2" Impact Wrench	174
<i>SM-4040</i>	Bead Breaker	150
<i>SM-40-7253P</i>	1/4" Mini Impact Wrench	15
<i>SM-40-7254P</i>	1/4" Mini Impact Wrench	15
<i>SM-40-7500</i>	1/4" Mini Impact Wrench	133
<i>SM-41-4001</i>	3/8" Stubby Impact Wrench	17
<i>SM-41-4002</i>	3/8" Stubby Impact Wrench	17
<i>SM-41-4012P</i>	3/8" Impact Wrench	4
<i>SM-41-4015P</i>	3/8" Stubby Impact Wrench	16
<i>SM-41-4015P2</i>	3/8" Stubby Impact Wrench	16
<i>SM-41-4017G</i>	3/8" Impact Wrench	25
<i>SM-41-4019P</i>	3/8" Impact Wrench	12
<i>SM-41-4024P</i>	3/8" Impact Wrench	8
<i>SM-41-4113P</i>	3/8" Impact Wrench	23
<i>SM-41-4114P</i>	3/8" Impact Wrench	20
<i>SM-41-7253P</i>	3/8" Mini Impact Wrench	15
<i>SM-41-7254P</i>	3/8" Mini Impact Wrench	15
<i>SM-41-7500</i>	3/8" Mini Impact Wrench	133
<i>SM-43-231F</i>	1/2" Impact Wrench	176
<i>SM-43-231FRG</i>	1/2" Impact Wrench	176
<i>SM-43-231H</i>	1/2" Impact Wrench	176
<i>SM-43-231HL</i>	1/2" Impact Wrench	176
<i>SM-43-231HRG</i>	1/2" Impact Wrench	176
<i>SM-43-231HRGK3</i>	1/2" Impact Wrench Kit	176
<i>SM-43-4001</i>	1/2" Stubby Impact Wrench	17
<i>SM-43-4002</i>	1/2" Stubby Impact Wrench	17
<i>SM-43-4011P</i>	1/2" Stubby Impact Wrench	18
<i>SM-43-4011P2</i>	1/2" Stubby Impact Wrench	18
<i>SM-43-4012A</i>	1/2" Mini Impact Wrench	6
<i>SM-43-4012P</i>	1/2" Mini Impact Wrench	4
<i>SM-43-4013P</i>	1/2" Stubby Impact Wrench	19
<i>SM-43-4013P2</i>	1/2" Stubby Impact Wrench	19
<i>SM-43-4015P</i>	1/2" Stubby Impact Wrench	16
<i>SM-43-4015P2</i>	1/2" Stubby Impact Wrench	16
<i>SM-43-4017G</i>	1/2" Mini Impact Wrench	25
<i>SM-43-4019A</i>	1/2" Mini Impact Wrench	14
<i>SM-43-4019P</i>	1/2" Mini Impact Wrench	12

Tool Index

Model No.	Description	
SM-43-4024P	1/2" Mini Impact Wrench	8
SM-43-4031P1	1/2" Impact Wrench	7
SM-43-4031P3	1/2" Impact Wrench	7
SM-43-4033A	1/2" Impact Wrench	6
SM-43-4033AL	1/2" Impact Wrench	6
SM-43-4033P	1/2" Impact Wrench	4
SM-43-4033P2	1/2" Impact Wrench	7
SM-43-4033PK	1/2" Impact Wrench Kit	11
SM-43-4033PK2	1/2" Impact Wrench Kit	11
SM-43-4033PK3	1/2" Impact Wrench Kit	11
SM-43-4033PL	1/2" Impact Wrench	4
SM-43-4034P	1/2" Impact Wrench	8
SM-43-4034PL	1/2" Impact Wrench	8
SM-43-4037G	1/2" Impact Wrench	25
SM-43-4038P	1/2" Super Impact Wrench	32
SM-43-4038PL	1/2" Super Impact Wrench - with 2" Ext. Anvil	32
SM-43-4039A	1/2" Impact Wrench	14
SM-43-4039P	1/2" Impact Wrench	12
SM-43-4039PL	1/2" Impact Wrench	12
SM-43-4113P	1/2" Mini Impact Wrench	23
SM-43-4114P	1/2" Mini Impact Wrench	20
SM-43-4131P1	1/2" Impact Wrench	24
SM-43-4131P2	1/2" Impact Wrench	24
SM-43-4131PL	1/2" Impact Wrench	24
SM-43-4133P1	1/2" Impact Wrench	23
SM-43-4133P2	1/2" Impact Wrench	23
SM-43-4133PL	1/2" Impact Wrench	23
SM-43-4134L	1/2" Impact Wrench	20
SM-43-4134P	1/2" Impact Wrench	20
SM-43-4137	1/2" Impact Wrench	176
SM-45-4051A	3/4" Impact Wrench	6
SM-45-4051P	3/4" Impact Wrench	5
SM-45-4051PL	3/4" Impact Wrench	5
SM-45-4054P	3/4" Impact Wrench	9
SM-45-4054PL	3/4" Impact Wrench	9
SM-45-4057G	3/4" Impact Wrench	25
SM-45-4057LG	3/4" Impact Wrench	25
SM-45-4059A	3/4" Impact Wrench	14
SM-45-4059P	3/4" Impact Wrench	13
SM-45-4059PL	3/4" Impact Wrench	13
SM-45-4151P	3/4" Impact Wrench	24
SM-45-4151PL	3/4" Impact Wrench	24
SM-45-4153P	3/4" Impact Wrench	23
SM-45-4154L	3/4" Impact Wrench	21
SM-45-4154P	3/4" Impact Wrench	21
SM-47-4051P	1" Impact Wrench	5
SM-47-4051PL	1" Impact Wrench	5
SM-47-4054P	1" Impact Wrench	9
SM-47-4054PL	1" Impact Wrench	9
SM-47-4057G	1" Impact Wrench	25
SM-47-4057LG	1" Impact Wrench	25
SM-47-4059P	1" Impact Wrench	13
SM-47-4059PL	1" Impact Wrench	13
SM-47-4071	1" Heavy Duty Impact Wrench	26
SM-47-4071L7	1" Heavy Duty Impact Wrench - Pinless Clutch	26
SM-47-4071L7K	1" Heavy Duty Impact Wrench Kit	27
SM-47-4071L9	1" Heavy Duty Impact Wrench - Pinless Clutch	26
SM-47-4071L9K	1" Heavy Duty Impact Wrench Kit	27

Model No.	Description	
SM-47-4072	1" Heavy Duty Impact Wrench	26
SM-47-4072L6	1" Heavy Duty Impact Wrench - Twin Hammer	26
SM-47-4072L6K	1" Heavy Duty Impact Wrench Kit	27
SM-47-4072L8	1" Heavy Duty Impact Wrench - Twin Hammer	26
SM-47-4072L8K	1" Heavy Duty Impact Wrench Kit	27
SM-47-4073	1" Impact Wrench	28
SM-47-4073L7	1" Impact Wrench	28
SM-47-4073L7Q	1" Impact Wrench (Lower Noise)	28
SM-47-4073L8	1" Impact Wrench	28
SM-47-4073L8Q	1" Impact Wrench (Lower Noise)	28
SM-47-4074	1" Impact Wrench	31
SM-47-4074L7	1" Impact Wrench	31
SM-47-4074L8	1" Impact Wrench	31
SM-47-4075	1" Impact Wrench	30
SM-47-4075L6	1" Impact Wrench	30
SM-47-4075L8	1" Impact Wrench	30
SM-47-4076	1" Impact Wrench	29
SM-47-4076L7	1" Impact Wrench	29
SM-47-4076L8	1" Impact Wrench	29
SM-47-4151P	1" Impact Wrench	24
SM-47-4151PL	1" Impact Wrench	24
SM-47-4153P	1" Impact Wrench	23
SM-47-4154L	1" Impact Wrench	21
SM-47-4154P	1" Impact Wrench	21
SM-48-7253P	1/4" Hex Impact Driver	15
SM-48-7254P	1/4" Hex Impact Driver	15
SM-48-7500	1/4" Impact Driver	133
SM-5001	Heavy Duty Straight Die Grinder	49
SM-501C	1/4" Die Grinder	185
SM-502	3/8" High Speed Drill	178
SM-50-240N	Die Grinder (24,000 RPM)	48
SM-50-240S	Die Grinder (24,000 RPM)	48
SM-50-241N	Die Grinder (24,000 RPM)	48
SM-50-241S	Die Grinder (24,000 RPM)	48
SM-50-250N	Die Grinder (24,000 RPM)	48
SM-50-250R	Die Grinder (24,000 RPM)	48
SM-50-250S	Die Grinder (24,000 RPM)	48
SM-50-280R	Die Grinder (24,000 RPM)	48
SM-50-281R	Die Grinder (24,000 RPM)	48
SM-50-290N	Die Grinder (24,000 RPM)	48
SM-50-290S	Die Grinder (24,000 RPM)	48
SM-50-291N	Die Grinde (24,000 RPM)	48
SM-50-291S	Die Grinder (24,000 RPM)	48
SM-50-5200	Die Grinder	59
SM-5115C	1/4" Die Grinder - 15,000 RPM	60
SM-5118C	1/4" Die Grinder - 18,000 RPM	60
SM-512	1/4" Die Grinder	184
SM-5120C	1/4" Die Grinder - 20,000 RPM	60
SM-5125A	1/4" Die Grinder - 25,000 RPM	60
SM-512F	1/4" Extended Die Grinder	184
SM-512K	1/4" Die Grinder Kit	184
SM-512SH	1/4" Die Grinder (Full Size)	161
SM-51-3011B	1/4" Die Grinder - Full Size	54
SM-51-3011X	1/4" Die Grinder - Full Size	55
SM-51-3011Y	1/4" Die Grinder - Full Size	56
SM-51-3011Z	1/4" Die Grinder - Full Size	57
SM-5130A	1/4" Die Grinder - 30,000 RPM	60
SM-51-5100	1/4" Die Grinder - Full Size	47

Tool Index

Model No.	Description	
SM-516	Micro Die Grinder (56,000 RPM)	187
SM-516K	Micro Die Grinder Kit (56,000 RPM)	187
SM-516K-B	Micro Die Grinder Kit (56,000 RPM)	187
SM-518	Auto Window Cut-Off Knife	191
SM-519	Auto Window Cut-Off Knife	191
SM-5218D	1/4" Die Grinder - 18,000 RPM	60
SM-522	1/4" Angle Die Grinder	185
SM-5220D	1/4" Die Grinder - 20,000 RPM	60
SM-5225B	1/4" Die Grinder - 25,000 RPM	60
SM-522SH	1/4" Mini Angle Die Grinder	161
SM-52-301B	Angle Die Grinder	61
SM-52-301X	Angle Die Grinder	61
SM-5230B	1/4" Die Grinder - 25,000 RPM	60
SM-52-3271	1/4" Angle Die Grinder	77
SM-52-512B	Angle Die Grinder	61
SM-52-5200	Angle Die Grinder	59
SM-52-5201	Angle Die Grinder	59
SM-52-52251	1/4" 90° Angle Die Grinder	51
SM-52-52252	1/4" 90° Angle Die Grinder	51
SM-52-5227	1/4" 90° Angle Die Grinder	53
SM-52-5227K	1/4" 90° Angle Die Grinder Kit	52
SM-52-5227K2	1/4" 90° Angle Die Grinder Kit	52
SM-52-5229	1/4" 90° Angle Die Grinder	53
SM-52-5300	1/4" 90° Angle Die Grinder	46
SM-526	Cut-Off Tool	185
SM-5263R	3" Reversible Cut-Off Tool	84
SM-5265R	3" Reversible Cut-Off Tool	84
SM-5265RK	Reversible Cut-Off Tool Kit	84
SM-532	1/4" Mini Die Grinder	184
SM-532E	1/4" Extended Mini Die Grinder	184
SM-532K	1/4" Mini Die Grinder Kit	184
SM-53-52251	1/4" Mini Die Grinder	51
SM-53-52252	1/4" Mini Die Grinder	51
SM-53-5227	1/4" Mini Die Grinder	53
SM-53-5227K	1/4" Mini Die Grinder Kit	52
SM-53-5229	1/4" Mini Die Grinder	53
SM-53-5300	1/4" Mini Die Grinder	46
SM-53-5522	Industrial Die Grinder	49
SM-53-5530	Industrial Die Grinder	49
SM-542	1/4" Heavy Duty Mini Angle Die Grinder	185
SM-54-3011B	1/4" Die Grinder	54
SM-54-3011X	1/4" Die Grinder	55
SM-54-3011Y	1/4" Die Grinder	56
SM-54-3011Z	1/4" Die Grinder	57
SM-545	1/4" Hand Die Grinder	185
SM-54-5100	1/4" Die Grinder	47
SM-552	1/4" Mini Die Grinder	185
SM-55-52251	1/4" 115° Angle Die Grinder	51
SM-55-52252	1/4" 115° Angle Die Grinder	51
SM-55-5227	1/4" 115° Angle Die Grinder	53
SM-55-5227SH	1/4" 115° Mini Angle Die Grinder	161
SM-55-5229	1/4" 115° Angle Die Grinder	53
SM-55-5300	1/4" 115° Angle Die Grinder	46
SM-562	1/4" Mini Angle Die Grinder	185
SM-562K	1/4" Mini Die Grinder Kit	185
SM-572FP	1/4" Extended Die Grinder	58
SM-572P	1/4" Air Die Grinder	58
SM-575P	1/4" Air Die Grinder	58

Model No.	Description	
SM-576P	3" Cut-Off Tool	58
SM-580	3/8" High Speed Straight Air Drill	183
SM-582	1/4" Die Grinder - Full Size	183
SM-582F	1/4" Extended Die Grinder	183
SM-585	1/4" Die Grinder	183
SM-586	3" Cut-Off Tool	183
SM-586A	3" Cut-Off Tool	183
SM-5B-3271	4" Angle Grinder & Cut-Off Tool	77
SM-5B-6192A	4" Angle Grinder	72
SM-5B-6192AS	4" Angle Grinder	72
SM-5B-6192PS	4" Angle Grinder	73
SM-5B-6192PSH	4" Angle Grinder	161
SM-5B-6400L	4" Angle Grinder	66
SM-5B-6400R	4" Angle Grinder	66
SM-5B-6410	4" Angle Grinder	70
SM-5B-6410R	4" Angle Grinder	70
SM-5B-6410S	4" Angle Grinder	71
SM-5B-6414	4" Angle Grinder	67
SM-5B-6414S	4" Angle Grinder	67
SM-5B-6422	4" Angle Grinder	68
SM-5C-3271	4-1/2" Angle Grinder & Cut-Off Tool	77
SM-5C-6192A	4-1/2" Angle Grinder	72
SM-5C-6192AS	4-1/2" Angle Grinder	72
SM-5C-6192PS	4-1/2" Angle Grinder	73
SM-5C-6410	4-1/2" Angle Grinder	70
SM-5C-6410R	4-1/2" Angle Grinder	70
SM-5C-6410S	4-1/2" Angle Grinder	71
SM-5C-6414	4-1/2" Angle Grinder	67
SM-5C-6414S	4-1/2" Angle Grinder	67
SM-5C-6422	4-1/2" Angle Grinder	68
SM-5D-3271	5" Angle Grinder & Cut-Off Tool	77
SM-5D-3272	5" Angle Grinder & Cut-Off Tool	77
SM-5D-6191PS	5" Angle Grinder	65
SM-5D-6192A	5" Angle Grinder	72
SM-5D-6192AS	5" Angle Grinder	72
SM-5D-6192AW	5" Air Wet Angle Sander (10,000 RPM)	76
SM-5D-6192PS	5" Angle Grinder	73
SM-5D-6400L	5" Angle Grinder	66
SM-5D-6400R	5" Angle Grinder	66
SM-5D-6410	5" Angle Grinder	70
SM-5D-6410R	5" Angle Grinder	70
SM-5D-6410S	5" Angle Grinder	71
SM-5D-6412	5" Angle Grinder	69
SM-5D-6412R	5" Angle Grinder	69
SM-5D-6414	5" Angle Grinder	67
SM-5D-6414S	5" Angle Grinder	67
SM-5D-6422	5" Angle Grinder	68
SM-5E-260N	Extended Die Grinder (24,000 RPM)	48
SM-5E-260R	Extended Die Grinder (24,000 RPM)	48
SM-5E-260S	Extended Die Grinder (24,000 RPM)	48
SM-5E-261N	Extended Die Grinder (24,000 RPM)	48
SM-5E-261R	Extended Die Grinder (24,000 RPM)	48
SM-5E-261S	Extended Die Grinder (24,000 RPM)	48
SM-5E-5200	Extended Die Grinder	59
SM-5E-52251	1/4" Extended Die Grinder	51
SM-5E-52252	1/4" Extended Die Grinder	51
SM-5E-5227	1/4" Extended Die Grinder	53
SM-5E-5229	1/4" Extended Die Grinder	53

Tool Index

Model No.	Description	
<i>SM-5E-5300</i>	1/4" Extended Die Grinder	46
<i>SM-5F-300C</i>	6" Vertical Grinder	63
<i>SM-5F-3011B</i>	1/4" Extended Die Grinder	54
<i>SM-5F-3011X</i>	1/4" Extended Die Grinder	55
<i>SM-5F-3011Y</i>	1/4" Extended Die Grinder	56
<i>SM-5F-3011Z</i>	1/4" Extended Die Grinder	57
<i>SM-5F-321C</i>	6" Vertical Grinder	64
<i>SM-5F-400C</i>	6" Vertical Grinder	63
<i>SM-5F-421C</i>	6" Vertical Grinder	64
<i>SM-5F-5100</i>	1/4" Extended Die Grinder	47
<i>SM-5G-300V</i>	7" Vertical Grinder	63
<i>SM-5G-321V</i>	7" Vertical Grinder	64
<i>SM-5G-400V</i>	7" Vertical Grinder	63
<i>SM-5G-421V</i>	7" Vertical Grinder	64
<i>SM-5G-6197</i>	7" Angle Grinder (8,500 RPM)	74
<i>SM-5G-6197W</i>	7" Air Wet Angle Sander (6,000 RPM)	76
<i>SM-5G-6198</i>	7" Angle Grinder (8,500 RPM)	74
<i>SM-5G-6413</i>	7" Angle Grinder	69
<i>SM-5G-6413R</i>	7" Angle Grinder	69
<i>SM-5G-6423</i>	7" Angle Grinder	68
<i>SM-5G-6700L</i>	7" Angle Grinder	66
<i>SM-5G-6700R</i>	7" Angle Grinder	66
<i>SM-5H-300V</i>	9" Vertical Grinder	63
<i>SM-5H-321V</i>	9" Vertical Grinder	64
<i>SM-5H-400V</i>	9" Vertical Grinder	63
<i>SM-5H-421V</i>	9" Vertical Grinder	64
<i>SM-5J-3011B</i>	3" Cut-Off Tool	54
<i>SM-5J-3011X</i>	3" Cut-Off Tool	55
<i>SM-5J-3011Y</i>	3" Cut-Off Tool	56
<i>SM-5J-3011Z</i>	3" Cut-Off Tool	57
<i>SM-5J-5100</i>	3" Cut-Off Tool	47
<i>SM-5J-5420</i>	2" Mini Cut-Off Tool	80
<i>SM-5J-5423</i>	2" Mini Angle Grinder & Cut-Off Tool	79
<i>SM-5J-5423K</i>	2" Mini Angle Grinder & Cut-Off Tool Kit	79
<i>SM-5J-8423</i>	3" Reversible Cut-Off tool	83
<i>SM-5J-8424</i>	3" Reversible Cut-Off tool	83
<i>SM-5K-3011B</i>	3" Cut-Off Tool - Long Neck	81
<i>SM-5K-3011S</i>	3" Cut-Off Tool	81
<i>SM-5K-6200</i>	3" Cut-Off Tool	80
<i>SM-5L-2011L</i>	4" Extended Cut-Off Tool	81
<i>SM-5L-3011B</i>	4" Cut-Off Tool - Long Neck	81
<i>SM-5L-3011S</i>	4" Cut-Off Tool	81
<i>SM-5L-5200</i>	4" Extended Cut-Off Tool	82
<i>SM-5M-130W</i>	Air Wet Stone Cutter (13,000 RPM)	76
<i>SM-6001-2</i>	2" Mini Disc Sander	103
<i>SM-6001-2K</i>	2" Mini Disc Sander Kit	104
<i>SM-6001-3</i>	3" Mini Disc Sander	103
<i>SM-6001-3K</i>	3" Mini Disc Sander Kit	104
<i>SM-6001K</i>	Mini Disc Sander Kit (2" & 3")	104
<i>SM-6002</i>	1/4" Mini Die Grinder	103
<i>SM-6002K</i>	1/4" Mini Die Grinder Kit	105
<i>SM-6003V-2</i>	2" Mini Orbital Sander	103
<i>SM-6003V-3</i>	3" Mini Orbital Sander	103
<i>SM-6003VK</i>	Mini Orbital Sander Kit (2" & 3")	105
<i>SM-6004</i>	3" Mini Polisher	103
<i>SM-6004K</i>	3" Mini Polisher Kit	105
<i>SM-6006</i>	3" Mini Orbital Sander	103
<i>SM-6008</i>	3" Mini Polisher	103

Model No.	Description	
<i>SM-603-5</i>	5" Random Orbital Sander	188
<i>SM-603-6</i>	6" Random Orbital Sander	188
<i>SM-603V-5</i>	5" Random Orbital Sander	188
<i>SM-603V-6</i>	6" Random Orbital Sander	188
<i>SM-60-7251A</i>	5" Reversible High Speed Sander	99
<i>SM-60-7253A</i>	5" Reversible High Speed Sander	99
<i>SM-60-7254A</i>	5" Reversible High Speed Sander	99
<i>SM-6102</i>	Vertical Polisher (3" & 6")	98
<i>SM-611W</i>	5" Air Wet Stone Sander / Polisher	76
<i>SM-61-5235</i>	Nib Removal Sander	86
<i>SM-61-5236</i>	Nib Removal Sander	86
<i>SM-61-6133</i>	1-1/4" Mini Random Orbital Nib Sander	86
<i>SM-61-6321-2</i>	2" Mini Disc Sander	100
<i>SM-61-6321-2K</i>	2" Mini Disc Sander Kit	101
<i>SM-61-6321-3</i>	3" Mini Disc Sander	100
<i>SM-61-6321-3K</i>	3" Mini Disc Sander Kit	101
<i>SM-61-6321K</i>	Mini Disc Sander Kit (2" & 3")	101
<i>SM-618W</i>	5" Air Wet Stone Sander / Polisher	76
<i>SM-619</i>	4" Angle Grinder	75
<i>SM-6190</i>	4-1/2" Angle Grinder & Sander	75
<i>SM-6194</i>	4-1/2" Angle Grinder	75
<i>SM-6194B</i>	4-1/2" Angle Grinder	75
<i>SM-6195</i>	5" Angle Grinder	75
<i>SM-6195A</i>	5" Angle Grinder	75
<i>SM-6195B</i>	5" Angle Grinder	75
<i>SM-619A</i>	4" Angle Grinder	75
<i>SM-6203</i>	7" Vertical Polisher	99
<i>SM-620SG</i>	20mm Belt Sander	111
<i>SM-62-6321</i>	1/4" Mini Die Grinder	100
<i>SM-62-6321K</i>	1/4" Mini Die Grinder Kit	102
<i>SM-6303</i>	7" Vertical Sander / Polisher	99
<i>SM-63-5137</i>	3" Buffer - Oil-Free	89
<i>SM-63-5237</i>	3" Buffer - Oil-Free	89
<i>SM-63-5432</i>	3" Buffer - Oil-Free	89
<i>SM-63-5437</i>	3" Buffer - Oil-Free	89
<i>SM-63-6133</i>	3" Buffer	89
<i>SM-63-6143A</i>	3" Random Orbital Palm Sander	87
<i>SM-63-6143C</i>	3" Random Orbital Palm Sander	87
<i>SM-63-6233</i>	3" Buffer	89
<i>SM-63-6243A</i>	3" Random Orbital Palm Sander	87
<i>SM-63-6243C</i>	3" Random Orbital Palm Sander	87
<i>SM-63-6321-2</i>	2" Mini Orbital Sander	100
<i>SM-63-6321-3</i>	3" Mini Orbital Sander	100
<i>SM-63-6321K</i>	Mini Orbital Sander Kit (2" & 3")	102
<i>SM-63-6432</i>	3" Buffer	89
<i>SM-63-6433</i>	3" Buffer	89
<i>SM-642W</i>	5" Air Wet Stone Sander / Polisher	76
<i>SM-645</i>	Stripping Tool	182
<i>SM-64-6321</i>	3" Mini Polisher	100
<i>SM-64-6321K</i>	3" Mini Polisher Kit	102
<i>SM-65-3271</i>	5" Angle Sander	77
<i>SM-6542</i>	2" Mini Angle Grinder	78
<i>SM-6542K</i>	2" Mini Angle Grinder Kit	78
<i>SM-65-5037</i>	5" Random Orbital Oil-Free Palm Sander	94
<i>SM-65-5037A</i>	5" Random Orbital Oil-Free Palm Sander	95
<i>SM-65-5037B</i>	5" Random Orbital Oil-Free Palm Sander	96
<i>SM-65-5037C</i>	5" Random Orbital Oil-Free Palm Sander	94
<i>SM-65-5132</i>	5" Two-Hand Sanders	91

Tool Index

Model No.	Description	
<i>SM-65-5132A</i>	5" Two-Hand Sanders	91
<i>SM-65-5137</i>	5" Random Orbital Oil-Free Palm Sander	94
<i>SM-65-5137A</i>	5" Random Orbital Oil-Free Palm Sander	95
<i>SM-65-5137B</i>	5" Random Orbital Oil-Free Palm Sander	96
<i>SM-65-5137C</i>	5" Random Orbital Oil-Free Palm Sander	94
<i>SM-65-5237</i>	5" Random Orbital Oil-Free Palm Sander	94
<i>SM-65-5237A</i>	5" Random Orbital Oil-Free Palm Sander	95
<i>SM-65-5237B</i>	5" Random Orbital Palm Sander	96
<i>SM-65-5237C</i>	5" Random Orbital Oil-Free Palm Sander	94
<i>SM-65-5837</i>	5" Random Orbital Oil-Free Palm Sander	94
<i>SM-65-5837A</i>	5" Random Orbital Oil-Free Palm Sander	95
<i>SM-65-5837B</i>	5" Random Orbital Oil-Free Palm Sander	96
<i>SM-65-5837C</i>	5" Random Orbital Oil-Free Palm Sander	94
<i>SM-65-6033</i>	5" Random Orbital Palm Sander	92
<i>SM-65-6033A</i>	5" Random Orbital Palm Sander	93
<i>SM-65-6033B</i>	5" Random Orbital Palm Sander	96
<i>SM-65-6033C</i>	5" Random Orbital Palm Sander	92
<i>SM-65-6132</i>	5" Two-Hand Sanders	91
<i>SM-65-6132A</i>	5" Two-Hand Sanders	91
<i>SM-65-6133</i>	5" Random Orbital Palm Sander	92
<i>SM-65-6133A</i>	5" Random Orbital Palm Sander	93
<i>SM-65-6133B</i>	5" Random Orbital Palm Sander	96
<i>SM-65-6133C</i>	5" Random Orbital Palm Sander	92
<i>SM-65-6233</i>	5" Random Orbital Palm Sander	92
<i>SM-65-6233A</i>	5" Random Orbital Palm Sander	93
<i>SM-65-6233B</i>	5" Random Orbital Palm Sander	96
<i>SM-65-6233C</i>	5" Random Orbital Palm Sander	92
<i>SM-65-6238</i>	5" Gear-Driven Sander/Polisher (900 RPM)	97
<i>SM-65-6636G</i>	5" Vertical Sander/Polisher	98
<i>SM-65-6833</i>	5" Random Orbital Palm Sander	92
<i>SM-65-6833A</i>	5" Random Orbital Palm Sander	93
<i>SM-65-6833B</i>	5" Random Orbital Palm Sander	96
<i>SM-65-6833C</i>	5" Random Orbital Palm Sander	92
<i>SM-660</i>	5" High Speed Sander with Regulator	188
<i>SM-661</i>	Tire Buffer	182
<i>SM-662</i>	Tire Buffer	182
<i>SM-66-5032</i>	6" Two-Hand Sanders	91
<i>SM-66-5032A</i>	6" Two-Hand Sanders	91
<i>SM-66-5037</i>	6" Random Orbital Oil-Free Palm Sander	94
<i>SM-66-5037A</i>	6" Random Orbital Oil-Free Palm Sander	95
<i>SM-66-5037B</i>	6" Random Orbital Oil-Free Palm Sander	96
<i>SM-66-5037C</i>	6" Random Orbital Oil-Free Palm Sander	94
<i>SM-66-5132</i>	6" Two-Hand Sanders	91
<i>SM-66-5132A</i>	6" Two-Hand Sanders	91
<i>SM-66-5137</i>	6" Random Orbital Oil-Free Palm Sander	94
<i>SM-66-5137A</i>	6" Random Orbital Oil-Free Palm Sander	95
<i>SM-66-5137B</i>	6" Random Orbital Oil-Free Palm Sander	96
<i>SM-66-5137C</i>	6" Random Orbital Oil-Free Palm Sander	94
<i>SM-66-5237</i>	6" Random Orbital Oil-Free Palm Sander	94
<i>SM-66-5237A</i>	6" Random Orbital Oil-Free Palm Sander	95
<i>SM-66-5237B</i>	6" Random Orbital Oil-Free Palm Sander	96
<i>SM-66-5237C</i>	6" Random Orbital Oil-Free Palm Sander	94
<i>SM-66-5837</i>	6" Random Orbital Oil-Free Palm Sander	94
<i>SM-66-5837A</i>	6" Random Orbital Oil-Free Palm Sander	95
<i>SM-66-5837B</i>	6" Random Orbital Oil-Free Palm Sander	96
<i>SM-66-5837C</i>	6" Random Orbital Oil-Free Palm Sander	94
<i>SM-66-6032</i>	6" Two-Hand Sanders	91
<i>SM-66-6032A</i>	6" Two-Hand Sanders	91

Model No.	Description	
<i>SM-66-6033</i>	6" Random Orbital Palm Sander	92
<i>SM-66-6033A</i>	6" Random Orbital Palm Sander	93
<i>SM-66-6033B</i>	6" Random Orbital Palm Sander	96
<i>SM-66-6033C</i>	6" Random Orbital Palm Sander	92
<i>SM-66-6132</i>	6" Two-Hand Sanders	91
<i>SM-66-6132A</i>	6" Two-Hand Sanders	91
<i>SM-66-6133</i>	6" Random Orbital Palm Sander	92
<i>SM-66-6133A</i>	6" Random Orbital Palm Sander	93
<i>SM-66-6133B</i>	6" Random Orbital Palm Sander	96
<i>SM-66-6133C</i>	6" Random Orbital Palm Sander	92
<i>SM-66-6233</i>	6" Random Orbital Palm Sander	92
<i>SM-66-6233A</i>	6" Random Orbital Palm Sander	93
<i>SM-66-6233B</i>	6" Random Orbital Oil-Free Palm Sander	96
<i>SM-66-6233C</i>	6" Random Orbital Palm Sander	92
<i>SM-66-6238</i>	6" Gear-Driven Sander/Polisher (900 RPM)	97
<i>SM-66-6238A</i>	6" Gear-Driven Sander/Polisher (900 RPM)	97
<i>SM-66-6321</i>	3" Mini Orbital Sander	100
<i>SM-66-6636G</i>	6" Vertical Sander/Polisher	98
<i>SM-66-6833</i>	6" Random Orbital Palm Sander	92
<i>SM-66-6833A</i>	6" Random Orbital Palm Sander	93
<i>SM-66-6833B</i>	6" Random Orbital Palm Sander	96
<i>SM-66-6833C</i>	6" Random Orbital Palm Sander	92
<i>SM-671P</i>	Low Speed Tire Buffer	58
<i>SM-67-6661</i>	7" Angle Sander (4,500 RPM)	75
<i>SM-680W</i>	5" Air Wet Stone Sander / Polisher	76
<i>SM-681</i>	Air Tire Buffer	183
<i>SM-682</i>	Air Tire Buffer	183
<i>SM-683</i>	Air Tire Buffer	183
<i>SM-68-6238</i>	8" Gear-Driven Sander/Polisher (900 RPM)	97
<i>SM-68-6238A</i>	8" Gear-Driven Sander/Polisher (900 RPM)	97
<i>SM-68-6321</i>	3" Mini Polisher	100
<i>SM-6902</i>	Utility Surface Blaster (Tool Only)	41
<i>SM-6902K</i>	Utility Surface Blaster Kit	42
<i>SM-6902K-7</i>	Utility Surface Blaster Kit - 7 Pieces onto One	43
<i>SM-6903</i>	Utility Surface Blaster (Tool Only)	41
<i>SM-6903K</i>	Utility Surface Blaster Kit	42
<i>SM-6903KF</i>	Utility Surface Blaster Kit	44
<i>SM-6C30</i>	Finger Sander	109
<i>SM-6C31</i>	Finger Sander	109
<i>SM-6F-3011B</i>	Low Speed Tire Buffer	54
<i>SM-6F-3011X</i>	Low Speed Tire Buffer	55
<i>SM-6F-3011Y</i>	Low Speed Tire Buffer	56
<i>SM-6F-3011Z</i>	Low Speed Tire Buffer	57
<i>SM-6F-5100</i>	Low Speed Tire Buffer	47
<i>SM-6K-3011B</i>	Pinstripe Removal Tool	54
<i>SM-6K-3011X</i>	Pinstripe Removal Tool	55
<i>SM-6K-3011Y</i>	Pinstripe Removal Tool	56
<i>SM-6K-3011Z</i>	Pinstripe Removal Tool	57
<i>SM-6K-5100</i>	Pinstripe Removal Tool	47
<i>SM-6N-6636</i>	5" Vertical Sander/Polisher	98
<i>SM-6N-6661</i>	7" Angle Polisher (2,500 RPM)	75
<i>SM-6P-6636</i>	6" Vertical Sander/Polisher	98
<i>SM-6T-6200</i>	20mm Belt Sander	111
<i>SM-6T-6202</i>	20mm Belt Sander - 20 mm x 520 mm	112
<i>SM-6W-6060</i>	6mm Belt Sander	111
<i>SM-6W-6100</i>	10mm Belt Sander - 10 mm x 330 mm	111
<i>SM-6W-6102</i>	13mm Belt Sander - 13 mm x 330 mm	111
<i>SM-6W-6120</i>	13mm Belt Sander - 13 mm x 610 mm	111

Tool Index

Model No.	Description	
<i>SM-6W-6203</i>	10mm Belt Sander - 10 mm x 330 mm	112
<i>SM-6X-6300</i>	30mm Belt Sander	111
<i>SM-6Z-6103</i>	Belt Sander	112
<i>SM-6Z-6103K</i>	Belt Sander Kit	112
<i>SM-6Z-6104</i>	Belt Sander	113
<i>SM-6Z-6104K</i>	Belt Sander Kit	113
<i>SM-6Z-6105</i>	Versatility Belt Sander	115
<i>SM-6Z-6201</i>	Belt Sander	114
<i>SM-6Z-6201K</i>	Belt Sander Kit	114
<i>SM-7005A</i>	1/2" Air Drill (500 RPM)	146
<i>SM-7009A</i>	1/2" Air Drill (900 RPM)	146
<i>SM-701</i>	3/8" Air Drill (2,200 RPM)	177
<i>SM-7017B</i>	3/8" Air Drill (1,900 RPM)	146
<i>SM-7017C-03</i>	3/8" Air Drill (1,700 RPM)	147
<i>SM-7017C-08</i>	3/8" Air Drill (1,700 RPM)	147
<i>SM-702</i>	3/8" Air Drill (2,000 RPM)	178
<i>SM-7026A</i>	3/8" Air Drill (2,600 RPM)	146
<i>SM-7029B</i>	3/8" Air Drill (3,200 RPM)	146
<i>SM-7029C-03</i>	3/8" Air Drill (2,900 RPM)	147
<i>SM-7029C-08</i>	3/8" Air Drill (2,900 RPM)	147
<i>SM-703</i>	1/2" Air Drill (500 RPM)	177
<i>SM-7032A</i>	3/8" Air Drill (3,200 RPM)	146
<i>SM-7038B</i>	3/8" Air Drill (3,900 RPM)	146
<i>SM-7038C-03</i>	3/8" Air Drill (3,800 RPM)	147
<i>SM-7038C-08</i>	3/8" Air Drill (3,800 RPM)	147
<i>SM-704</i>	1/2" Reversible Air Drill (800 RPM)	177
<i>SM-705</i>	3/8" Reversible Air Drill (1,800 RPM)	177
<i>SM-705SH</i>	3/8" Reversible Drill	161
<i>SM-706</i>	3/8" Air Drill (2,600 RPM)	177
<i>SM-7060A</i>	3/8" Air Drill (6,000 RPM)	146
<i>SM-706L</i>	3/8" Heavy-Duty Air Drill	152
<i>SM-709</i>	3/8" Angle Drill (1,900 RPM)	177
<i>SM-7091R</i>	3/8" Reversible Angle Drill (1,200 RPM)	145
<i>SM-709R</i>	3/8" Reversible Angle Drill (1,800 RPM)	177
<i>SM-710</i>	3/8" Straight Air Drill	178
<i>SM-712</i>	1/2" Air Drill (400 RPM)	178
<i>SM-7138B</i>	1/4" Air Drill (3,900 RPM)	146
<i>SM-7138C-03</i>	1/4" Air Drill (3,800 RPM)	147
<i>SM-7160A</i>	1/4" Air Drill (6,000 RPM)	146
<i>SM-71-7100-01</i>	3/8" Non-Reversible Air Drill (2,200 RPM)	135
<i>SM-71-7802</i>	Spot Drill	149
<i>SM-71-7802K</i>	Spot Drill Kit	149
<i>SM-720</i>	3/8" Air Drill (2,600 RPM)	178
<i>SM-721</i>	Spot Weld Drill	149
<i>SM-721K</i>	Spot Weld Drill Kit	149
<i>SM-724</i>	1/2" Reversible Drill (800 RPM)	178
<i>SM-725</i>	3/8" Reversible Drill (1,800 RPM)	178
<i>SM-72-7063-03</i>	1/2" Non-Reversible Air Drill (1,000 RPM)	142
<i>SM-72-7253P</i>	1/2" Non-Reversible Air Drill (1,000 RPM)	139
<i>SM-72-7254P</i>	1/2" Non-Reversible Air Drill (1,000 RPM)	140
<i>SM-728</i>	1/4" Mini Air Drill (2,800 RPM)	178
<i>SM-7281</i>	1/4" Mini Air Drill (2,800 RPM)	137
<i>SM-7282</i>	1/4" Mini Air Drill (2,800 RPM)	137
<i>SM-7282NK</i>	1/4" Mini Air Drill (2,800 RPM)	137
<i>SM-7283</i>	1/4" Mini Air Drill (2,800 RPM)	137
<i>SM-72831-2</i>	2" Mini Disc Sander	106
<i>SM-72831-2K</i>	2" Mini Disc Sander Kit	107
<i>SM-72831-3</i>	3" Mini Disc Sander	106

Model No.	Description	
<i>SM-72831-3K</i>	3" Mini Disc Sander Kit	107
<i>SM-72831K</i>	Mini Disc Sander Kit (2" & 3")	107
<i>SM-72832</i>	1/4" Mini Die Grinder	106
<i>SM-72832K</i>	Mini Die Grinder Kit	108
<i>SM-72833-2</i>	2" Mini Orbital Sander	106
<i>SM-72833-3</i>	3" Mini Orbital Sander	106
<i>SM-72833K</i>	Mini Orbital Sander Kit (2" & 3")	108
<i>SM-72834</i>	3" Mini Polisher	106
<i>SM-72834K</i>	3" Mini Polisher Kit	108
<i>SM-72835</i>	2" Mini Grinder	106
<i>SM-7283NK</i>	1/4" Mini Air Drill (2,800 RPM)	137
<i>SM-734</i>	1/2" Reversible Air Drill (400 RPM)	177
<i>SM-73-7063-03</i>	1/2" Non-Reversible Air Drill (500 RPM)	142
<i>SM-73-7100-01</i>	1/2" Non-Reversible Air Drill (500 RPM)	135
<i>SM-73-7251-03</i>	1/2" Reversible Air Drill (400 RPM)	142
<i>SM-746</i>	3/8" Straight Air Drill	178
<i>SM-747</i>	Tire Buffer	182
<i>SM-74-7251-03</i>	1/2" Reversible Air Drill (800 RPM)	142
<i>SM-74-7253P</i>	1/2" Reversible Air Drill (800 RPM)	139
<i>SM-74-7254P</i>	1/2" Reversible Air Drill (800 RPM)	140
<i>SM-74-7500-02</i>	1/2" Reversible Air Drill (800 RPM)	135
<i>SM-748</i>	3/8" Air Drill (4,800 RPM)	177
<i>SM-7511</i>	3/8" Heavy Duty Air Drill (2,200 RPM)	143
<i>SM-751P-02</i>	3/8" Heavy Duty Air Drill (2,200 RPM)	141
<i>SM-751P-04</i>	3/8" Heavy Duty Air Drill (2,200 RPM)	141
<i>SM-7531</i>	1/2" Heavy Duty Air Drill (500 RPM)	143
<i>SM-75-7251-03</i>	3/8" Reversible Air Drill (1,800 RPM)	142
<i>SM-75-7253P</i>	3/8" Reversible Air Drill (1,800 RPM)	139
<i>SM-75-7254P</i>	3/8" Reversible Air Drill (1,800 RPM)	140
<i>SM-75-7500-02</i>	3/8" Reversible Air Drill (2,000 RPM)	135
<i>SM-76-3011B</i>	3/8" Straight Air Drill	54
<i>SM-76-3011X</i>	3/8" Straight Air Drill	55
<i>SM-76-3011Y</i>	3/8" Straight Air Drill	56
<i>SM-76-3011Z</i>	3/8" Straight Air Drill	57
<i>SM-76-5100</i>	3/8" Straight Air Drill	47
<i>SM-76-7063-03</i>	3/8" Non-Reversible Air Drill (2,600 RPM)	142
<i>SM-76-7100-01</i>	3/8" Non-Reversible Air Drill (2,600 RPM)	135
<i>SM-76-7253P</i>	3/8" Non-Reversible Air Drill (2,600 RPM)	139
<i>SM-76-7254P</i>	3/8" Non-Reversible Air Drill (2,600 RPM)	140
<i>SM-77-7500-02</i>	1/2" Reversible Air Drill (400 RPM)	135
<i>SM-780</i>	3/8" Straight Air Drill	183
<i>SM-781</i>	3/8" Straight Air Drill	183
<i>SM-7845-02</i>	1/2" Reversible Air Drill (350 RPM)	144
<i>SM-786</i>	3/8" Straight Air Drill	183
<i>SM-78-7281R</i>	1/4" Mini Reversible Air Drill (2,500 RPM)	137
<i>SM-78-7284P</i>	1/4" Non-Reversible Mini Air Drill (2,600 RPM)	138
<i>SM-78-7284P-02</i>	1/4" Non-Reversible Mini Air Drill (2,600 RPM)	138
<i>SM-78-7284PR</i>	1/4" Reversible Mini Air Drill (2,600 RPM)	138
<i>SM-78-7284PR-02</i>	1/4" Reversible Mini Air Drill (2,600 RPM)	138
<i>SM-7915</i>	3/8" Standard Duty Air Drill (2,600 RPM)	143
<i>SM-7935</i>	1/2" Air Drill (1,000 RPM)	143
<i>SM-7941P-02</i>	1/2" Reversible Air Drill (800 RPM)	141
<i>SM-7941P-04</i>	1/2" Reversible Air Drill (800 RPM)	141
<i>SM-7942-03</i>	1/2" Reversible Air Drill (500 RPM)	144
<i>SM-7945-02</i>	1/2" Reversible Air Drill (650 RPM)	144
<i>SM-7951P-02</i>	3/8" Reversible Air Drill (1,800 RPM)	141
<i>SM-7951P-04</i>	3/8" Reversible Air Drill (1,800 RPM)	141
<i>SM-7952-04</i>	3/8" Reversible Air Drill (1,800 RPM)	144

Tool Index

Model No.	Description	
SM-7955	3/8" Reversible Air Drill (1,800 RPM)	143
SM-7955-02	3/8" Reversible Air Drill (1,650 RPM)	144
SM-79-8423R	3/8" Reversible Angle Drill (1,400 RPM)	145
SM-7985	3/8" Heavy Duty Air Drill (4,800 RPM)	143
SM-7A-3011B	3/8" Straight Air Drill	54
SM-7A-3011X	3/8" Straight Air Drill	55
SM-7A-3011Y	3/8" Straight Air Drill	56
SM-7A-3011Z	3/8" Straight Air Drill	57
SM-7A-5100	3/8" Straight Air Drill	47
SM-7B-3011B	3/8" Straight Air Drill	54
SM-7B-3011X	3/8" Straight Air Drill	55
SM-7B-3011Y	3/8" Straight Air Drill	56
SM-7B-3011Z	3/8" Straight Air Drill	57
SM-7B-5100	3/8" Straight Air Drill	47
SM-7H-7535	Industrial Air Drill (13 mm)	153
SM-7H-7538	Industrial Air Drill (16 mm)	153
SM-7L-3011B	3/8" High Speed Straight Air Drill	54
SM-7L-3011X	3/8" High Speed Straight Air Drill	55
SM-7L-3011Y	3/8" High Speed Straight Air Drill	56
SM-7L-3011Z	3/8" High Speed Straight Air Drill	57
SM-7L-5100	3/8" High Speed Straight Air Drill	47
SM-802	1/4" Air Screwdriver (1,800 RPM)	179
SM-802K	Air Screwdriver Kit	179
SM-803	1/4" Air Screwdriver (800 RPM)	179
SM-806	1/4" Air Screwdriver (800 RPM)	179
SM-80-7251	1/4" Air Screwdriver (1,800 RPM)	128
SM-812	1/4" Air Screwdriver (1,800 RPM)	180
SM-813	1/4" Air Screwdriver (800 RPM)	180
SM-816	1/4" Air Screwdriver (800 RPM)	180
SM-81-7251	1/4" Air Screwdriver (1,800 RPM)	128
SM-820	1/4" Air Screwdriver (2,000 RPM)	180
SM-8225	1/4" Air Screwdriver (1,800 RPM)	129
SM-8225F	1/4" Air Screwdriver (1,800 RPM)	130
SM-8235	1/4" Air Screwdriver (800 RPM)	129
SM-8235F	1/4" Air Screwdriver (800 RPM)	130
SM-8245	1/4" Air Screwdriver (1,800 RPM)	129
SM-8265	1/4" Air Screwdriver (800 RPM)	129
SM-82-7251	1/4" Air Screwdriver (1,800 RPM)	127
SM-82-7251F	1/4" Air Screwdriver (1,800 RPM)	128
SM-82-7253P	1/4" Air Screwdriver (1,800 RPM)	125
SM-82-7253PF	1/4" Air Screwdriver (1,800 RPM)	125
SM-82-7254P	1/4" Air Screwdriver (1,800 RPM)	126
SM-82-7254PF	1/4" Air Screwdriver (1,800 RPM)	126
SM-82-7500	1/4" Air Screwdriver (1,800 RPM)	134
SM-82-7500F	1/4" Air Screwdriver (1,800 RPM)	134
SM-82-8423F	1/4" Straight Air Screwdriver (1,800 RPM)	131
SM-832	1/4" Air Screwdriver (1,800 RPM)	179
SM-833	1/4" Air Screwdriver (800 RPM)	179
SM-83-7251	1/4" Air Screwdriver (800 RPM)	127
SM-83-7251F	1/4" Air Screwdriver (800 RPM)	128
SM-83-7253P	1/4" Air Screwdriver (800 RPM)	125
SM-83-7253PF	1/4" Air Screwdriver (800 RPM)	125
SM-83-7254P	1/4" Air Screwdriver (800 RPM)	126
SM-83-7254PF	1/4" Air Screwdriver (800 RPM)	126
SM-83-7500	1/4" Air Screwdriver (800 RPM)	134
SM-83-7500F	1/4" Air Screwdriver (800 RPM)	134
SM-83-8423F	1/4" Straight Air Screwdriver (800 RPM)	131
SM-842	1/4" Air Screwdriver (1,800 RPM)	181

Model No.	Description	
SM-842F	1/4" Straight Air Screwdriver (1,800 RPM)	131
SM-843	1/4" Air Screwdriver (800 RPM)	181
SM-843F	1/4" Straight Air Screwdriver (800 RPM)	131
SM-844	1/4" Air Screwdriver (1,800 RPM)	181
SM-846	1/4" Air Screwdriver (800 RPM)	181
SM-84-7251	1/4" Air Screwdriver (1,800 RPM)	127
SM-84-7253P	1/4" Air Screwdriver (1,800 RPM)	125
SM-84-7254P	1/4" Air Screwdriver (1,800 RPM)	126
SM-84-7500	1/4" Air Screwdriver (1,800 RPM)	134
SM-84-8020	1/4" Air Screwdriver (1,800 RPM)	179
SM-84-8140	1/4" Air Screwdriver (1,800 RPM)	180
SM-852	1/4" Air Screwdriver (1,800 RPM)	180
SM-853	1/4" Air Screwdriver (800 RPM)	180
SM-85-7251	1/4" Air Screwdriver (800 RPM)	128
SM-862	1/4" Air Screwdriver (1,800 RPM)	181
SM-863	1/4" Air Screwdriver (800 RPM)	181
SM-86-7251	1/4" Air Screwdriver (800 RPM)	127
SM-86-7253P	1/4" Air Screwdriver (800 RPM)	125
SM-86-7254P	1/4" Air Screwdriver (800 RPM)	126
SM-86-7500	1/4" Air Screwdriver (800 RPM)	134
SM-872	1/4" Straight Air Screwdriver (1,800 RPM)	182
SM-873	1/4" Straight Air Screwdriver (800 RPM)	182
SM-87-7251	1/4" Air Screwdriver (800 RPM)	128
SM-882	1/4" Air Screwdriver (1,800 RPM)	182
SM-883	1/4" Air Screwdriver (800 RPM)	182
SM-88-7251	1/4" Air Screwdriver (1,800 RPM)	122
SM-88-7251WB	Wheel Bolt Cleaner Kit	151
SM-88-7253P	1/4" Air Screwdriver (1,800 RPM)	123
SM-88-7254P	1/4" Air Screwdriver (1,800 RPM)	123
SM-88-7500	1/4" Air Screwdriver (1,800 RPM)	133
SM-88-8020	1/4" Air Screwdriver (1,800 RPM)	122
SM-88-8225	1/4" Air Screwdriver (1,800 RPM)	122
SM-89-7251	1/4" Air Screwdriver (800 RPM)	122
SM-89-7253P	1/4" Air Screwdriver (800 RPM)	123
SM-89-7254P	1/4" Air Screwdriver (800 RPM)	123
SM-89-7500	1/4" Air Screwdriver (800 RPM)	133
SM-89-8020	1/4" Air Screwdriver (800 RPM)	122
SM-89-8225	1/4" Air Screwdriver (800 RPM)	122
SM-911	Double Suction Cup	194
SM-9111	Double Suction Cup	194
SM-9111K	Double Suction Cup Kit with Strap	194
SM-911K	Double Suction Cup Kit with Strap	194
SM-911KNH	Double Suction Cup Kit without Strap	194
SM-9825	1/4" Air Screwdriver (1,800 RPM)	130
SM-9835	1/4" Air Screwdriver (800 RPM)	130
SM-AS002	Auto Shut-off Screwdriver (600 RPM)	121
SM-AS002A	Auto Shut-off Screwdriver (600 RPM)	121
SM-AS004	Auto Shut-off Screwdriver (600 RPM)	120
SM-AS005	Auto Shut-off Screwdriver (650 RPM)	121
SM-AS102	Auto Shut-off Screwdriver (1,000 RPM)	121
SM-AS102A	Auto Shut-off Screwdriver (1,000 RPM)	121
SM-AS104	Auto Shut-off Screwdriver (1,000 RPM)	120
SM-AS105	Auto Shut-off Screwdriver (1,100 RPM)	121
SM-AS202	Auto Shut-off Screwdriver (1,800 RPM)	121
SM-AS202A	Auto Shut-off Screwdriver (1,800 RPM)	121
SM-AS204	Auto Shut-off Screwdriver (1,800 RPM)	120
SM-AS205	Auto Shut-off Screwdriver (1,800 RPM)	121
SM-AS304	Auto Shut-off Screwdriver (2,300 RPM)	120

Tool Index

Model No.	Description		Model No.	Description	
SM-AS305	Auto Shut-off Screwdriver (2,300 RPM)	121	#10033-11	1/2" Standard keyed chuck	135
SM-BP-0412T	Auto Shut-Off Screwdriver (400 RPM)	118	#10033-12	1/2" Standard keyless chuck	135
SM-BP-0810T	Auto Shut-Off Screwdriver (800 RPM)	118	#10033-13	1/2" Industrial keyed chuck	135
SM-BP-1008T	Auto Shut-Off Screwdriver (1,000 RPM)	118	#10033-14	1/2" Industrial keyless chuck	135
SM-BP-1305T	Auto Shut-Off Screwdriver (1,300 RPM)	118	#10035-11	3/8" Standard keyed chuck	135
SM-BP-2004T	Auto Shut-Off Screwdriver (2,000 RPM)	118	#10035-12	3/8" Standard keyless chuck	135
SM-BS-0412L	Auto Shut-Off Screwdriver (400 RPM)	119	#10035-13	3/8" Industrial keyed chuck	135
SM-BS-0412P	Auto Shut-Off Screwdriver (400 RPM)	119	#10035-14	3/8" Industrial keyless chuck	135
SM-BS-0810L	Auto Shut-Off Screwdriver (850 RPM)	119	#10455-11	Flat Chisel	170
SM-BS-0810P	Auto Shut-Off Screwdriver (850 RPM)	119	#10455-12	Flat Chisel	170
SM-BS-1008L	Auto Shut-Off Screwdriver (1,000 RPM)	119	#10455-13	Flat Chisel	170
SM-BS-1008P	Auto Shut-Off Screwdriver (1,000 RPM)	119	#32-301538-11	Standard Anvil	36
SM-BS-1405L	Auto Shut-Off Screwdriver (1,350 RPM)	119	#32-301620-11	Screwdriver Bits	37
SM-BS-1405P	Auto Shut-Off Screwdriver (1,350 RPM)	119	#32-301620-12	Screwdriver Bits	37
SM-BS-2004L	Auto Shut-Off Screwdriver (2,000 RPM)	119	#32-301621-11	Screwdriver Bits	37
SM-BS-2004P	Auto Shut-Off Screwdriver (2,000 RPM)	119	#32-301621-12	Screwdriver Bits	37
SM-CL-0426L	Auto Shut-Off Angle Nutrunner (350 RPM)	119	#32-301640-11	1/4" & 3/8" Anvil	37
SM-DH-100V	1" Chipping Hammer	154	#32-301641-11	1/4" Bit Holder	37
SM-DH-200V	2" Chipping Hammer	154	#32-301642-11	3/8" Anvil & 1/4" Bit Holder	37
SM-DH-300V	3" Chipping Hammer	154	#32-301643-11	1/4" Anvil & 1/4" Bit Holder	37
SM-DH-400V	4" Chipping Hammer	154	#33-301538-11	Standard Anvil	36
SM-DR-100V	1" Chipping Hammer	154	#33-301538-12	Wobble Anvil	36
SM-DR-200V	2" Chipping Hammer	154	#41-401255-0028	Rubber Boot	4
SM-DR-300V	3" Chipping Hammer	154	#41-402455-0028	Rubber Boot	8
SM-DR-400V	4" Chipping Hammer	154	#43-403355-0028	Rubber Boot	4
SM-EL-0207L	Auto Shut-Off Angle Nutrunner (150 RPM)	116	#43-403455-0028	Rubber Boot	8
SM-EL-0705L	Auto Shut-Off Angle Nutrunner (650 RPM)	116	#45-405165-0028	Rubber Boot	5
SM-EL-1004L	Auto Shut-Off Angle Nutrunner (950 RPM)	116	#45-405455-0028	Rubber Boot	9
SM-EL-1403L	Auto Shut-Off Angle Nutrunner (1,400 RPM)	116	#50-500228-11	Industry Standard Erickson Collet (1/4")	59
SM-EP-0205T	Auto Shut-Off Screwdriver (150 RPM)	116	#50-500228-13	Industry Standard Erickson Collet (3mm)	59
SM-EP-0705T	Auto Shut-Off Screwdriver (650 RPM)	116	#50-500228-16	Industry Standard Erickson Collet (6mm)	59
SM-EP-1005T	Auto Shut-Off Screwdriver (950 RPM)	116	#50-500228-18	Industry Standard Erickson Collet (8mm)	59
SM-EP-1404T	Auto Shut-Off Screwdriver (1,400 RPM)	116	#51228	Double Ended Spanner Wrench	84
SM-ES-0205L	Auto Shut-Off Screwdriver (150 RPM)	117	#51851	2-1/4" Blade (57mm)	191
SM-ES-0205P	Auto Shut-Off Screwdriver (150 RPM)	117	#51852	1-3/8" Short Blade (35mm)	191
SM-ES-0705L	Auto Shut-Off Screwdriver (650 RPM)	117	#51853	1-1/4" Curved Blade (30mm)	191
SM-ES-0705P	Auto Shut-Off Screwdriver (650 RPM)	117	#51854	3-1/2" Blade (90mm)	191
SM-ES-1005L	Auto Shut-Off Screwdriver (950 RPM)	117	#51855	3/4" Blade (18mm)	191
SM-ES-1005P	Auto Shut-Off Screwdriver (950 RPM)	117	#51857	1-1/2" Blade (36mm)	191
SM-ES-1404L	Auto Shut-Off Screwdriver (1,400 RPM)	117	#51858	2-1/2" Blade (63mm)	191
SM-ES-1404P	Auto Shut-Off Screwdriver (1,400 RPM)	117	#51859	3-1/2" Blade (90mm)	191
SM-G3-5132	3" Gear-Driven Sander / Polisher - Oil-free	90	#51860	5/16" Scraper Blade (8mm)	191
SM-G3-6132	3" Gear-Driven Sander/Polisher	90	#51861	1-3/8" Serrated Blade (35mm)	191
SM-G4-5132	4" Gear-Driven Sander / Polisher - Oil-free	90	#51862	1-3/8" Blade (35mm)	191
SM-G4-6132	4" Gear-Driven Sander/Polisher	90	#52227	Spanner Wrench	106
SM-G5-5132	5" Gear-Driven Sander / Polisher - Oil-free	90	#52630	3" Cutting Wheel	84
SM-G5-6132	5" Gear-Driven Sander/Polisher	90	#5A-7283A40	Pin Wrench	78
SM-P611	Paving Breaker	155	#5B-321145	Standard Side Handle	77
SM-P612	Paving Breaker	155	#5D-619256	Standard Side Handle	71
SM-P911	Paving Breaker	155	#5G-619753	Vibration Reduced Handle	71
SM-P912	Paving Breaker	155	#5J-542007	2" Cutting Wheel	79
SM-TH-1830	Air Chipping Hammer	167	#5L-321139	4" Cutting Wheel	77
#0511	11mm Wire Brush (Fine)	42	#5M-130W35-11	Getter Blade (110 x 20 mm)	76
#0523	23mm Wire Brush (Fine)	42	#5M-321139	4-1/2" Cutting Wheel	77
#0711	11mm Wire Brush (Coarse)	42	#5N-321139	5" Cutting Wheel	77
#0723	23mm Wire Brush (Coarse)	42	#600627V-31	3" Sanding Pad	98
#10012	Hex Key Wrench	106	#610227V-61	6" Sanding Pad	98
#10014	Hex Key Wrench	84	#610227V-62	6" Sanding Pad - Velcro	75

Tool Index

Model No.	Description	
#610227V-63	6" Sanding Pad - Velcro	75
#61558-21	1/4" Air Regulator (Aluminum)	195
#619041-11	4-1/2" Plastic Pad	75
#61939	4" Grinding Wheel	77
#619539	5" Grinding Wheel	77
#619539-12	4-1/2" Grinding Wheel	77
#654248-11	Spanner Wrench	78
#66027	3" Pad	99
#66028	4" Pad	99
#66029	5" Pad	99
#66-6138A42	6" Sanding Pad	97
#68-6138A42	8" Sanding Pad	97
#6N-663131V-6	Polishing Pad - Velcro	97
#6N-663131V-8	Polishing Pad - Velcro	97
#6N-663609-11	Silencer	98
#6N-663617-11S	Silencer	98
#6N-663636-11	#80 Grit 5" White Compounding Pad - Velcro	90
#6N-663637-11	#70 Grit 5" Yellow Compounding Pad - Velcro	90
#6N-663638-11	7" Wool Polishing Pad - Velcro	98
#6N-666125V-72	7" Sanding Pad - Velcro	75
#6N-666125V-73	7" Sanding Pad - Velcro	75
#6N-666125V-82	8" Sanding Pad - Velcro	75
#6N-666125V-83	8" Sanding Pad - Velcro	75
#6N-666131	Wool Polishing Pad	75
#6N-666131V-6	Wool Polishing Pad - Velcro	75
#6N-666131V-7	Wool Polishing Pad - Velcro	75
#6N-666131V-8	Wool Polishing Pad - Velcro	75
#6N-666132	7" Plastic Pad	75
#6P-663636-11	#80 Grit Compounding Pad - Velcro	97
#6P-663637-11	#70 Grit Compounding Pad - Velcro	97
#6U-610541	Contact Arm	115
#6V-610541	Contact Arm	115
#71-780139	Tungsten Carbide Drill Bit (ø 10.3 x 47 mm)	149
#71-780140	Tungsten Carbide Drill Bit (ø 8.3 x 47 mm)	149
#71-780141	Tungsten Carbide Drill Bit (ø 6.3 x 47 mm)	149
#75-725139-11S	Side Handle	135
#75-725153-11	Muffler Material for Quiet Series	20
#80253-103	Comfort Grip	162
#80253-105	Comfort Grip	162
#80253-108	Comfort Grip	162
#802F37-11	Red Spring (ø 3.2 mm)	126
#802F37-12	Blue Spring (ø 3.5 mm)	126
#81352-105	Comfort Grip	162
#81352-108	Comfort Grip	162
#822339-11S	Side Handle	135
#82252-108	Comfort Grip	162
#B4-16065	Spare Wheel Dia. 160 mm x 65mm	160
#B4-16075	Spare Wheel Dia. 160 mm x 75mm	160
#H1118002-11	Flat Chisel	167
#H1118003-11	Spot Weld Bracket	167
#H1118006-11	Tail Pipe Cutter	167
#H1118013-11	Double Edge Cutter	167
#H1118025-11	Shred Metal Trimmer	167
6U-6103060	Normal Abrasive Belts 13mm x 12", #60 grit	112
6U-6103080	Normal Abrasive Belts 13mm x 12", #80 grit	112
6U-6103120	Normal Abrasive Belts 13mm x 12", #120 grit	112
6U-610341	Contact Arm : 1/2" x 12" (13 mm x 305 mm)	112
6U-6103PB15	Surface Prep Belt 13mm x 12", #150 grit	112

Model No.	Description	
6U-6103PB30	Surface Prep Belt 13mm x 12", #300 grit	112
6V-610341	Contact Arm : 6 mm or 13 mm x 305 mm	112
6X-6103060	Normal Abrasive Belts 6mm x 12", #60 grit	112
6X-6103080	Normal Abrasive Belts 6mm x 12", #80 grit	112
6X-6103120	Normal Abrasive Belts 6mm x 12", #120 grit	112
6X-610341	Contact Arm : 1/4" x 12"(6 mm x 305 mm)	112
6Y-610341	Contact Arm : 1/2" x 12" (13 mm x 305 mm)	112
AS000149-11	Strong Spring (ø 3.5 mm)	120
AS000149-11SUB	Cam Assembly	120
AS000149-12	Medium Spring (ø 2.8 mm)	120
AS000149-12SUB	Cam Assembly	120
AS000149-13	Light Spring (ø 2.0 mm)	120
AS000149-13SUB	Cam Assembly	120
B4-1360	Screw Cleaner (1/2" x 60L)	157
B4-1401	Impact Driven Holder	158
B4-1425	2" Velcro Sanding Pad	159
B4-1426	3" Velcro Sanding Pad	159
B4-1427	2" Sanding Backup Pad	159
B4-1428	3" Sanding Backup Pad	159
B4-1440	Spare Grinding Wheel Dia. 40 mm	158
B4-1450	Spare Grinding Wheel Dia. 50 mm	158
B4-14K	Wheel Hub Bolt Grinder Kit	158
B4-160/65	Wheel Hub Grinder OD 160 mm (ID 65 mm)	160
B4-160/75	Wheel Hub Grinder OD 160 mm (ID 75 mm)	160
B4-2037	Screw Cleaner (M20 x 37L)	157
B4-20A02-11	Adapter to 1/2" SQ. Dr.	157
B4-2237	Screw Cleaner (M22 x 37L)	157
B4-2285	Screw Cleaner (M22 x 85L)	157
B4-2437	Screw Cleaner (M24 x 37L)	157
B4-3060	Screw Cleaner (M30 x 60L)	157
B4WSA	Wheel Bolt Cleaner Kit	157
BM-136010	Adapter for All Screw Cleaners	157
BM-136012	Spare Brush for Screw Cleaners	157
BM-203712	Spare Brush for Screw Cleaners	157
BM-203713-11	Wire Brush (M20)	151
BM-223712	Spare Brush for Screw Cleaners	157
BM-223713-11	Wire Brush (M22)	151
BM-243712	Spare Brush for Screw Cleaners	157
BM-243713-11	Wire Brush (M24)	151
BM-306012	Spare Brush for Screw Cleaners	157
BM-306013-11	Wire Brush (M30)	151
BM-306017-11	Wire Brush (M30)	151
CRA-51036	Universal Joint Chisel	165
CRA-51038	Smoothing Hammer Chisel	165
CRA-51053	3/8" Drive Air Hammer Socket Adapter	165
CRA-51056	1/2" Drive Air Hammer Socket Adapter	165
EH-43-4033SUB	Exhaust Hose Assembly	5
EH-45-4051SUB	Exhaust Hose Assembly	5
EH-47-407457-11SUB	Exhaust Hose Assembly For SM-47-4075	30
EH-512SUB	Exhaust Hose Assembly	58
EH-522SUB	Exhaust Hose Assembly	50
EH-5D-6410-11SUB	Exhaust Hose Assembly	71
EH-6133ASUB	Exhaust Hose Assembly	91
EH-6191SUB	Exhaust Hose Assembly	65
EH-6192SUB	Exhaust Hose Assembly	72
EH-6238ASUB	Exhaust Hose Assembly	97
EH-701SUB	Exhaust Hose Assembly	161
EH-701SUB-18	Exhaust Hose Assembly	77

Tool Index

Model No.	Description	
<i>G-102</i>	Quick Change Retainer	168
<i>G-118R</i>	Quick Change Retainer	167
<i>G-301</i>	Mini Oiler	195
<i>G4-513243-11</i>	#80 Grit 4" White Compounding Pad - Velcro	90
<i>G4-513244-11</i>	#70 Grit 4" Yellow Compounding Pad - Velcro	90
<i>G5-513257</i>	Hook	89
<i>PK-SG2618</i>	Safety Glasses	78
<i>QN-38</i>	Quick Nut (3/8"-24UNF)	71
<i>QN-58</i>	Quick Nut (5/8"-11UNC)	71
<i>QN-M14</i>	Quick Nut (M14x2.0P)	71
<i>SA-0101S</i>	Spring Retainer	164
<i>SA-0825S</i>	4 pcs File Set	193
<i>SA-12</i>	Universal Air Connectors - 1/2" NPT	195
<i>SA-14</i>	Universal Air Connectors - 1/4" NPT	195
<i>SA-2060SD</i>	#60 Grit Sanding Disc 2" Dia.	101
<i>SA-2080SD</i>	#80 Grit Sanding Disc 2" Dia.	101
<i>SA-2100SD</i>	#100 Grit Sanding Disc 2" Dia.	101
<i>SA-2100SD</i>	#100 Grit Sanding Disc 2" Dia.	107
<i>SA-2120SD</i>	#120 Grit Sanding Disc 2" Dia.	101
<i>SA-225</i>	Nylon Air Recoil Hoses (Swivel Head)	195
<i>SA-225PU</i>	1/4" P.U. Air Recoil Hoses (Swivel Head)	195
<i>SA-24S</i>	24 Teeth Saw Blade for SG-0822	190
<i>SA-250</i>	Nylon Air Recoil Hoses (Swivel Head)	195
<i>SA-250PU</i>	1/4" P.U. Air Recoil Hoses (Swivel Head)	195
<i>SA-3060SD</i>	#60 Grit Sanding Disc 3" Dia.	101
<i>SA-3080SD</i>	#80 Grit Sanding Disc 3" Dia.	101
<i>SA-3080SD</i>	#80 Grit Sanding Disc 3" Dia.	107
<i>SA-3100SD</i>	#100 Grit Sanding Disc 3" Dia.	101
<i>SA-3120SD</i>	#120 Grit Sanding Disc 3" Dia.	101
<i>SA-325</i>	Nylon Air Recoil Hoses (Swivel Head)	195
<i>SA-325PU</i>	1/4" P.U. Air Recoil Hoses (Swivel Head)	195
<i>SA-32S</i>	32 Teeth Saw Blade for SG-0822	190
<i>SA-350</i>	Nylon Air Recoil Hoses (Swivel Head)	195
<i>SA-350PU</i>	1/4" P.U. Air Recoil Hoses (Swivel Head)	195
<i>SA-38</i>	Universal Air Connectors - 3/8" NPT	195
<i>SA-430PU</i>	1/4" P.U. Air Recoil Hoses (Swivel Head)	195
<i>SA-450PU</i>	1/4" P.U. Air Recoil Hoses (Swivel Head)	195
<i>SA-60012P</i>	2" Sanding Backup Pad	101
<i>SA-60012SP</i>	2" Surface Prep Pad	101
<i>SA-60013P</i>	3" Sanding Backup Pad	101
<i>SA-60013SP</i>	3" Surface Prep Pad	101
<i>SA-6003V-2P</i>	2" Velcro Sanding Pad	102
<i>SA-6003V-3P</i>	3" Velcro Sanding Pad	102
<i>SA-6902BHD</i>	Adaptor for Double Black Strip Wheels	42
<i>SA-6902BHS</i>	Adaptor for Single Black Strip Wheel	42
<i>SA-6902BW</i>	Black Strip Wheel	42
<i>SA-6902RH</i>	Adaptor for Rubber Eraser or 23mm Brush	42
<i>SA-6902RW</i>	Rubber Eraser	42
<i>SA-6902RWW</i>	Water Based Paint Rubber Eraser	42
<i>SA-6902WH</i>	Adaptor for 11mm	42
<i>SA-6903RH</i>	Adaptor for Rubber Eraser or 23mm Brush	42
<i>SA-6903RW</i>	Rubber Eraser	42
<i>SA-6903RWW</i>	Water Based Paint Rubber Eraser	42
<i>SA-6903WH</i>	Adaptor for 11mm Wire Brush	42
<i>SA-6S060AB</i>	25mm x 18", #60 grit	114
<i>SA-6S080AB</i>	25mm x 18", #80 grit	114
<i>SA-6S6201</i>	Contact Arm 25mm	114
<i>SA-6T060AB</i>	20mm x 18", #60 grit	114

Model No.	Description	
<i>SA-6T080AB</i>	20mm x 18", #80 grit	114
<i>SA-6T080PB</i>	Surface Prep Belt 20mm x 18", #80 grit	114
<i>SA-6T6201</i>	Contact Arm 20mm	114
<i>SA-6U080AB</i>	13mm x 18", #80 grit	114
<i>SA-6U120AB</i>	13mm x 18", #120 grit	114
<i>SA-6U300PB</i>	Surface Prep Belt 13mm x 18", #300 grit	114
<i>SA-6U6201</i>	Contact Arm 13mm	114
<i>SA-6V120AB</i>	10mm x 18", #120 grit	114
<i>SA-6V150AB</i>	10mm x 18", #150 grit	114
<i>SA-6V6201</i>	Contact Arm 10mm	114
<i>SA-6W6201</i>	Contact Arm 10mm	114
<i>SA-6X150AB</i>	6mm x 18", #150 grit	114
<i>SA-6X6201</i>	Contact Arm 6mm	114
<i>SA-72835120</i>	#120 Grit 2" Grinding Wheel	78
<i>SA-7283560</i>	#60 Grit 2" Grinding Wheel	78
<i>SA-7283580</i>	#80 Grit 2" Grinding Wheel	78
<i>SA-75543VC</i>	3" Yellow Compounding Pad - Velcro	90
<i>SA-75653VC</i>	3" White Compounding Pad - Velcro	90
<i>SA-77213</i>	3-1/2" Bonnet	102
<i>SA-BM-2037-0011</i>	Screw Cleaner (M20)	151
<i>SA-BM-2237-0013</i>	Screw Cleaner (M22)	151
<i>SA-BM-2437-0015</i>	Screw Cleaner (M24)	151
<i>SA-BM-3060-0018</i>	Screw Cleaner (M30)	151

Piping System

Air mains and lines should be large enough to avoid excessive pressure loss under conditions of maximum flow.

In air lines, as in aftercoolers, water is continually precipitated as the air cools. For this reason pipe lines should be provided with a means of draining or trapping this water before it reaches the hose outlets.

It is advisable to pitch the mains in the direction of air flow so that both gravity and air flow will carry the water to traps or water legs located at frequent intervals. These should be drained regularly and never allowed to become full and inoperative. Use of automatic traps will eliminate manual draining and the possibility of traps becoming full.

However traps which drain to sewers can waste a considerable amount of air unless regularly inspected and kept in good working order.

Provision for quick and positive inspection of operation and for leakage should be made when traps are installed.

Three-way cocks or stop and waste cocks in the drains are usually provided for this purpose.

To aid in preventing condensed moisture from reaching the tools, down pipes or hose connections should never be taken directly from the bottom of air pipes or mains.

Connection should be made at the top of the main and a long radius return bend used.

Leaders, valves and hose connections should be large enough to pass the maximum amount of air required by the tool or tools on the line. This is particularly important if manifolds, from which several hose lines run, are used.

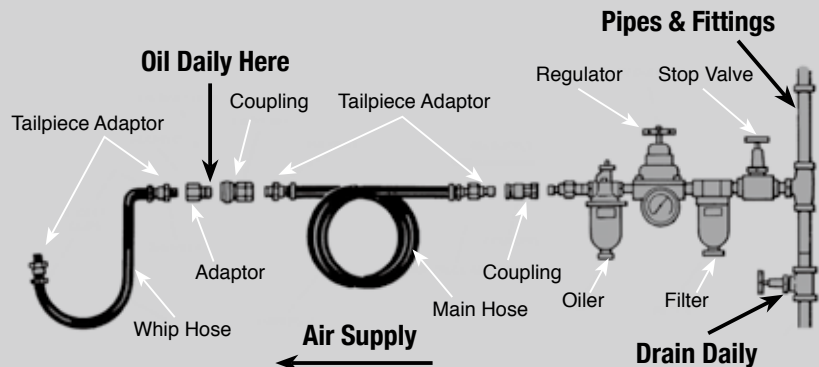
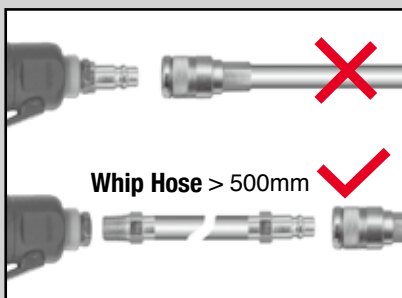

Air Regulators

Clean, dry, lubricated air at the proper pressure is the most important requirement for proper operation of air tools. SUNTECH tools are designed to operate at 90 PSI. unless otherwise specified.

Moisture Separators

On installations where the piping system does not provide clean, dry air, the use of filters at hose connection points is recommended. A good filter, kept properly drained, will remove nearly all entrained water whereas a poor one is practically useless. Most filters do not have adequate water storage capacity and, unless provided with an auxiliary storage receiver or automatic trap, soon cease to function.

Strainers

Many tools are provided with air strainers. To eliminate air restriction these strainers must be kept clean and free of obstructions. Strainers or filters should be used at each hose outlet, particularly where pipe lines are old or are used intermittently.

Lubrication

Many pneumatic tools, because of weight and space limitations, do not contain built-in lubricators. With such tools are line lubricators must always be used and their use is recommended with all air tools.

Moisture Elimination

The amount of moisture carried by compressed air varies with the temperature drops after compression, water is precipitated. In order to eliminate as much water as possible, compressors should be equipped with intercoolers, aftercoolers, and full size receivers. These should be kept drained and in good working condition.

Compressor Intake

Locate the intake to obtain the coolest, driest and cleanest air available. Intakes should be of ample size and as direct as possible. Avoid steam pipes, escaping steam and dusty or wet locations (as near roofs, floors, ground, etc...). When practical, take air from out-of-door on the north side of the building. Provide proper screening and protection. Intake filters of suitable size should be used.

One Year Limited Warranty

The manufacturer warrants this equipment to the original user against defective material or workmanship for a period of **one year** from the date of purchase on repair parts and labor. The manufacturer's responsibility under this warranty is limited to the repair or replacement of defective part or parts.

The manufacturer reserves the right to determine whether the part or parts failed because of defective material, workmanship or other causes. Failures caused by accident, alteration, misuse or improper packaging or purposely damage or attempted to repair or returned units are not covered by this warranty.

All warranty repairs must be done by SUNTECH Pneumatic Tool Service Representative or by SUNTECH factory. Any repair to the equipment other than by these authorized facilities voids this warranty. The rights under this warranty are limited to the original user and may not be transferred to subsequent owners.

SUNMATCH INDUSTRIAL CO., LTD.

ADDRESS : 296-1 Chung Shan Road, Chupei City, Hsinchu County 30281, Taiwan
PHONE : +886 (0)3 5519099 FAX : +886 (0)3 5558204 • 5552465
E-MAIL : info@sunmatch.com http://www.sunmatch.com

* Specifications and design may be changed without notice for improvement.

Printed in Taiwan 08/2017
© Copyright 2017 Sunmatch Ind. Co., Ltd.



ОФИЦИАЛЬНЫЙ ДИЛЕР В УКРАИНЕ:

storgom.ua

ГРАФИК РАБОТЫ:

Пн. – Пт.: с 8:30 по 18:30

Сб.: с 09:00 по 16:00

Вс.: с 10:00 по 16:00

КОНТАКТЫ:

+38 (044) 360-46-77

+38 (066) 77-395-77

+38 (097) 77-236-77

+38 (093) 360-46-77

Детальное описание товара: <https://storgom.ua/product/shlifmashina-suntech-sm-6-0sg-rg.html>

Другие товары: <https://storgom.ua/pnevmoshlifovalnyemashiny.html>