

# CIRCULATING PUMP



water...is life!



## Introduction

Until recently, central heating installations in private house building used mainly gravity water circulation. In such a cycle, the water circulates in the installation thanks to the density difference caused by temperature difference between the supply (the outlet of heated water from the boiler) and the return (the inlet of cool water from the radiators back into the boiler). The faults of such a system include significant inertia, non-uniform distribution of heat and big diameter pipelines. Presence of a pump in a central heating installation allows to reduce considerably the cross section of the wire. Moreover thanks to the automatic system control the fuel consumption decreases. Having a pump in the heating installation helps to reduce capital and operating costs. Pumps designed for central heating installations are equipped with a wet motor, and due to that they are called sealed glandless pumps. The pumped water reduces the friction in slide bearings and cools the motor. Such a construction has many advantages. One of which is no need for constant maintenance. As opposed to gland pumps, they do not require constant maintenance - lubrication or seal replacement. Another advantage is that they are silent running. Silent running has been achieved by using slide bearings in the rotor shaft. Moreover, the turning components of the pump are lipped by water, which also helps to reduce the noise. Glandless pumps are known for their long-term durability. Service life of such a pump is up to 15-20 years, which equals approximately 100 000 hours of work.

We reserve the right to alter technical characteristics of Speroni products at any time without notice, as well as to correct mistakes in our catalogue.

## Pumps with rotors working in a liquid medium

In wet-rotor pumps, the rotor is submerged in the medium and at the same time it is a component of the electric motor.

The sleeve sealing the motor is made of high-quality stainless steel and it protects the stator from being flooded. The pump shaft is made of corrosion-resistant material and it is equipped with ceramic/graphite bearings. The pump's sealing is static. The pumped medium fulfils two functions: it cools the pump and reduces the friction in bearings.

Wet-rotor pumps are noiseless and do not require significant expenditure on maintaining them in technical efficiency. Pumps with three rotational speeds, regulated with the use of U type switch, and UE type electronically controlled pumps are also types of wet-rotor pumps.

## Selection of a pump

### Choosing a pump with three rotational speeds

Characteristic properties of the pumps are shown in the form of characteristic curves illustrating pressure  $H$ , power  $P$  and the level of pump usage depending on flow  $Q$ .

Data on the required pressure flow and drop in the system / installation is included in the project documentation. In order to choose the right pump, the mentioned above data should be compared with technical characteristics of the pumps.

The calculated point  $R$ , with the coordinates  $Q_r$  and  $H_r$ , is the very basis for choosing the right pump. A pump with three rotational speeds has the  $Q$ - $H$  characteristics for each speed (see figure 1). The pump operates in the actual working point  $D$ .

The estimated point marks at the same time the point of intersection of the hydraulic resistance curve in the installation, and  $Q$ - $H$  curve of a certain pump.

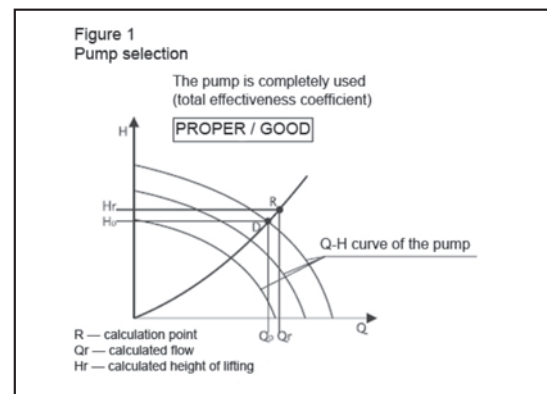

## Viscosity of working media

All hydraulic data, as well as other data included in the technical catalogue apply to water as the working media, with the kinematic viscosity of 1 mm<sup>2</sup>/sec.

If there is no information on working media in the description of a particular pump, then in order to achieve normal functionality of the pump you should provide a pure medium, which is of the same standard as liquid heating water (according to the VDI 2035 requirements specifying water hardness and pH-value) without any aggressive, explosive or mineral oil additives and hard or fibre particles.

Kinematic viscosity of water can be up to 10 mm<sup>2</sup>/sec.

If viscosity of water ranges from 1 to 10 mm<sup>2</sup>/sec, then the addition of an antifreeze agent (e.g. glycol) does not influence considerably the functioning of the pump.

### Selection of electronically controlled pumps

Functioning of electronically controlled pumps has been adjusted to annual heating energy consumption standards. The average annual consumption is showed in figure 2, illustrating seasonal overload.

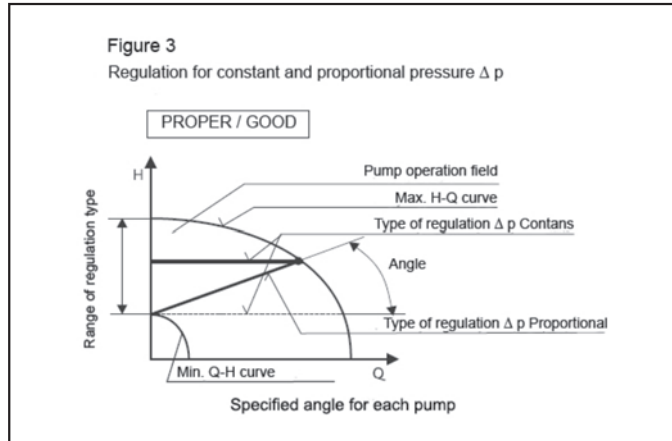
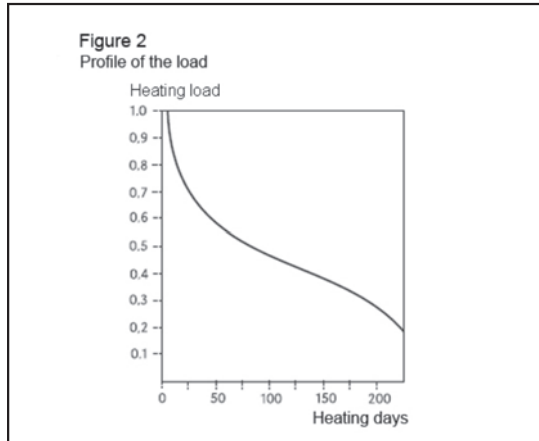

The proper selection of regulated pumps is shown in figures 3, 4 and 5. (Comparison of pump's characteristics determined by the design with actual technical characteristics of a particular pump).

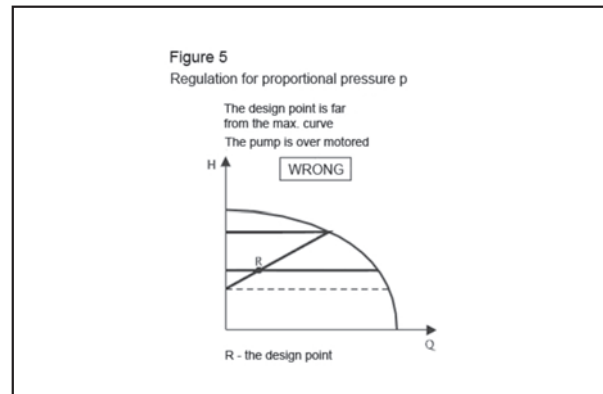
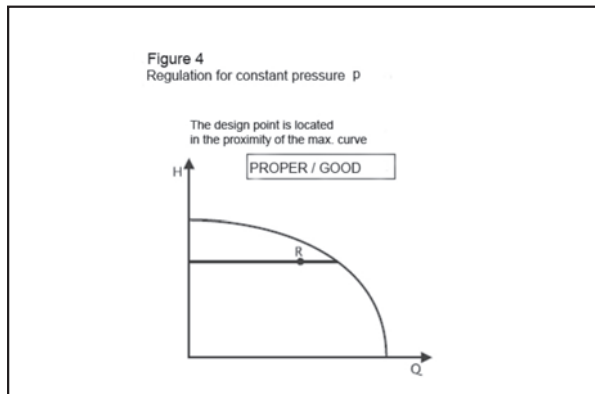

While using regulated pumps you can benefit from the operational field of a particular pump, which ranges from the minimal to the maximal Q-H curves. That is why such a regulation type is called stepless thermal regulation. The R design point should be located as close as possible to the functional max. Q-H curve.

As shown in the figure illustrating the annual heating load, the heating system works on full load of thermal power only for several days throughout the year. Throughout the rest of the year the power consumption is reduced by the electronic pump control system. When it comes to optimal operation of the system (also with the use of thermostatic valves mounted on heating systems), a large amount of energy can be saved thanks to regulated pumps. Therefore, replacing non-regulated pumps with regulated pumps helps to save money and energy. The savings are shown in figure 6.

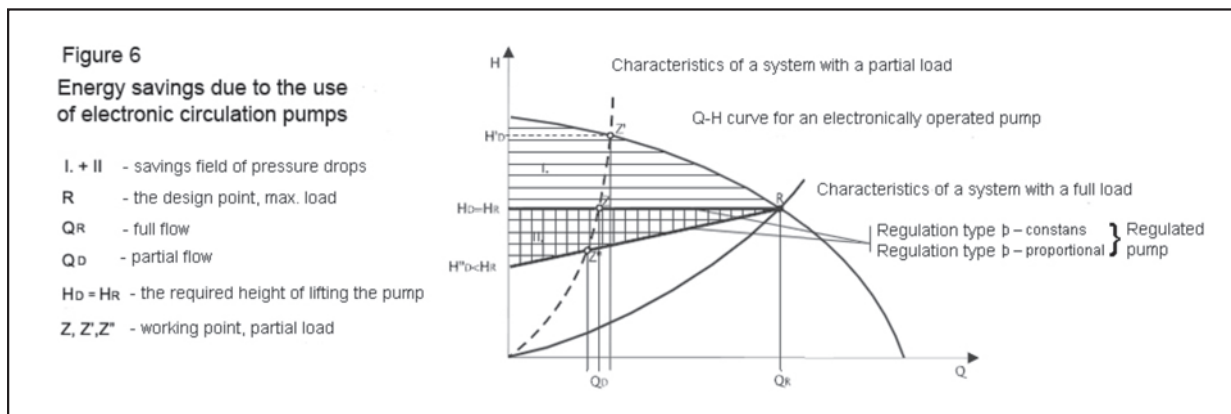

## Practical advice

### Electrical connection

Connect the electric cables and earthing with a slight sag to the terminal strip, and plug in according to the marking.

- L - phase
- N - neutral conductor
- ⏏ - earthing

External electric protection is not required.

The pump motor can be placed freely at 90° to the pump body, nevertheless it is important that the cable lead is not turned upwards and the terminal box is not located below the motor (see figures 2, A1, A2, A3, A4).

The terminal box connection and the contacts between the box and the motor winding must be protected against humidity. It is forbidden to mount pumps in high humidity rooms.

### Starting the pump

In order to reduce the noise, which is caused by the presence of air in a pump, it is necessary to vent the pump properly.

Therefore you should:

- fill the installation with a heating medium
- vent the installation
- open radiator valves to make sure if there is flow in the installation
- start the pump
- change over to the max. rotational speed (speed III)
- twist off the bleeder screw allowing the free flow of air
- eventually turn on the rotational speed

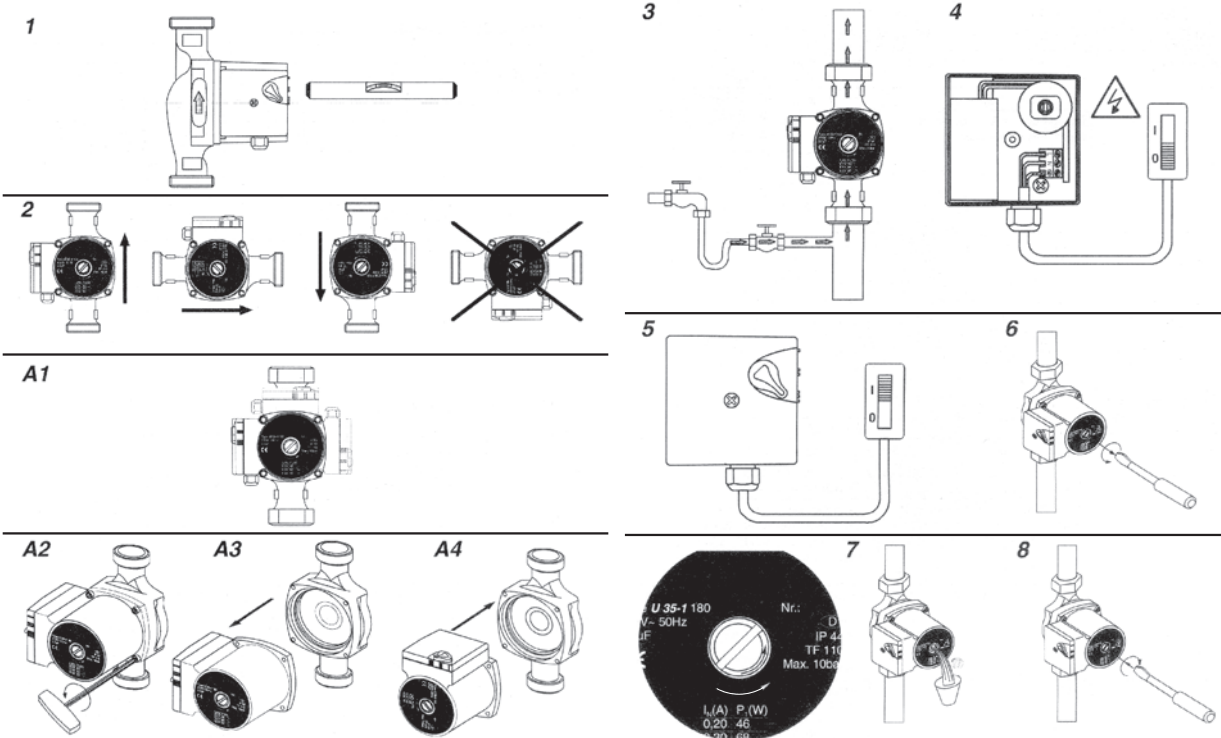

### Pump operation

The pump does not require any operation while it is on.

The flow can be controlled by changing the rotational speed with a switch located on the electric box. Adjustments can be made while the pump is operating.

## Troubleshooting

Troubleshooting	Cause	Action
Pump is not working	Electricity is not switched on	Check: fuses, loose electrical connections, electric cables
	Capacitor is defective	Replace the capacitor
	Pump fails to start	Change over to max. rotational speed Unlock the rotor - twist off the bleeder screw and turn the pump shaft with a screwdriver Replace the starting capacitor
Poor performance	Dirty rotor	Dismantle the head and clean the rotor
	Air in the pump	Vent the installation Vent the pump Mount an air classifier
	Inlet pressure too low	Increase the inlet pressure Check the air volume in the membrane vessel (if there is any)
	Low rotational speed	Change over to greater rotational speed
Noise in the pump	Air in the pump	Vent the installation Vent the pump Mount an air classifier
	Noise caused by cavitation	Increase the flow pressure Reduce the heating medium temperature Reduce the pump rotational speed Reduce flow on the valve behind the pump
	Too high performance	Reduce the rotational speed

**INDEX**

Pumping Technology	2 - 6
SCRA	7
SCR	8 - 9
SCRE	10 - 11
SCRE PLUS	12 - 14
SCRSE 15/15-65	15 - 17
SCRS	18 - 19
SCRFB	20 - 24
SCRFE	25 - 27
SCRFD	28 - 32
SCRFEED	33 - 35

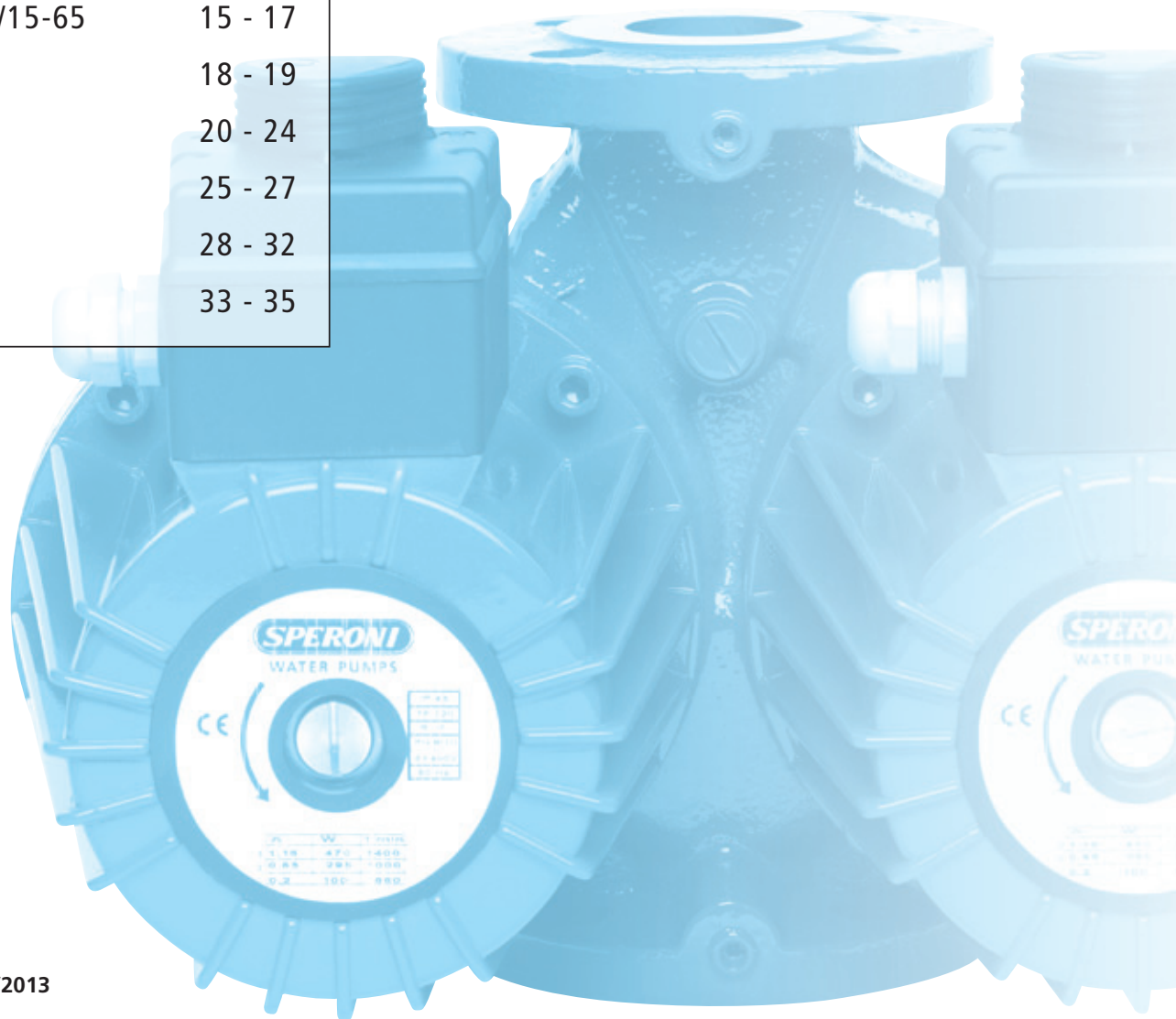

Revisione 4 - 02/2013

**Technical Characteristics.**

The technical data and characteristics stated in this General Catalogue are not binding.

SPERONI spa reserves the right to make modifications without notice.

Therefore weights, dimensions, performances and any other stated issues are indicative only and not binding.

Anyway for any technical details you must require an up-to-date product technical card.

**Competent Court.**

In case of any dispute the competent Court will be one of Reggio Emilia even if the payment is by bill of exchange.



### Applications

Circulating pump designed for pressure boosting of water in domestic properties.

The pump provides additional pressure to showers, taps.

The pumps incorporates a flow switch starts or stops the pump when a tap is turned on or off

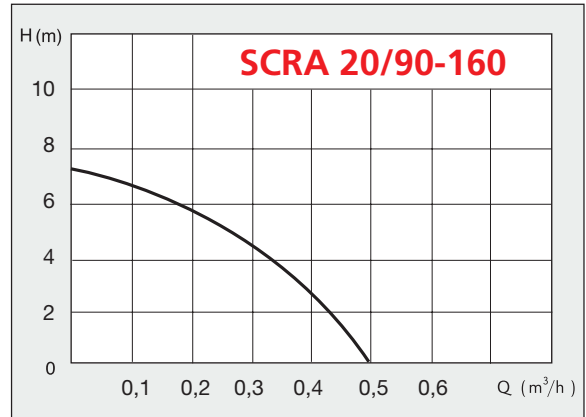

### Motor

- Input power P1 120 W
- Nominal power P2 40 W
- Capacitor 3 µF
- Current input 0,48 A
- Single-phase 230 V - 50 Hz.
- Duty continuous S1
- Insulation class H
- Protection IP 42
- 2 pole induction motor

### Operating condition

- Liquid temperature max 70 °C.
- Ambient temperature up to 40 °C.

### Pump

- Pressure lead min. 3/4"
- Delivery head max. 7,5m
- Capacity max. 0,5 m³/h
- Flows up to 1,4 m³/h

### Components

- Pump body Cast iron
- Impeller Noryl
- Shaft Stainless steel
- Motor housing Aluminium



### Applications

Circulating pump designed for pressure boosting of water in domestic properties. The pump provides additional pressure to showers, taps and similar outlet points for domestic water.

The pump incorporates a flow switch which starts or stops the pump when a tap is turned on or off

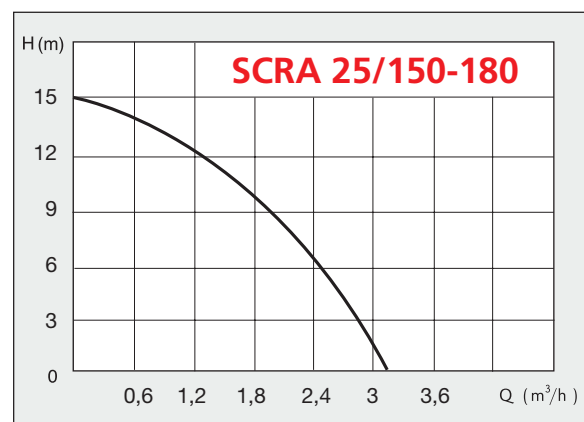

### Motor

- Input power P1 305 W
- Nominal power P2 110 W
- Capacitor 8 µF
- Current input 1,35 A
- Single-phase 230 V - 50 Hz.
- Duty continuous S1
- Insulation class F
- Protection IP 42
- 2 pole induction motor

### Components

- Pump body Cast iron
- Impeller Noryl
- Shaft Stainless steel
- Motor housing Aluminium

### Operating condition

- Liquid temperature max 70 °C.
- Ambient temperature up to 40 °C.

### Pump

- Pressure lead min. 1"
- Delivery head max. 15m
- Capacity max. 3,12 m³/h
- Flows up to 1,4 m³/h

## Central heating circulation pumps

### SCR 40 - SCR 60 - SCR 80

#### Technical data

- single-phase motor with a wet rotor
- three rotational speeds
- operating voltage: 1 x 230 V~50 Hz
- max. operating pressure: 10 bar
- media temperature: 5°C to 110°C max.
- ambient temperature: 40°C max.
- protection type: IP 44
- connection: external thread GZ 1", 1 1/4", 1 1/2" (standard), 2"
- length: 180 mm (standard), 130 mm, 110 mm (brass)



The pump has been created to pump warm water in central heating systems, however it can be used to pump liquid media in industrial and commercial usage. The pump may also be a part of a solar heating installation.

The articles are manufactured from the highest quality cast iron and chrome-nickel steel, which guarantees that the products are of high quality. The product has a ceramic bearing ring and a rotor disk made of technical polymer.

#### Pumps' characteristics

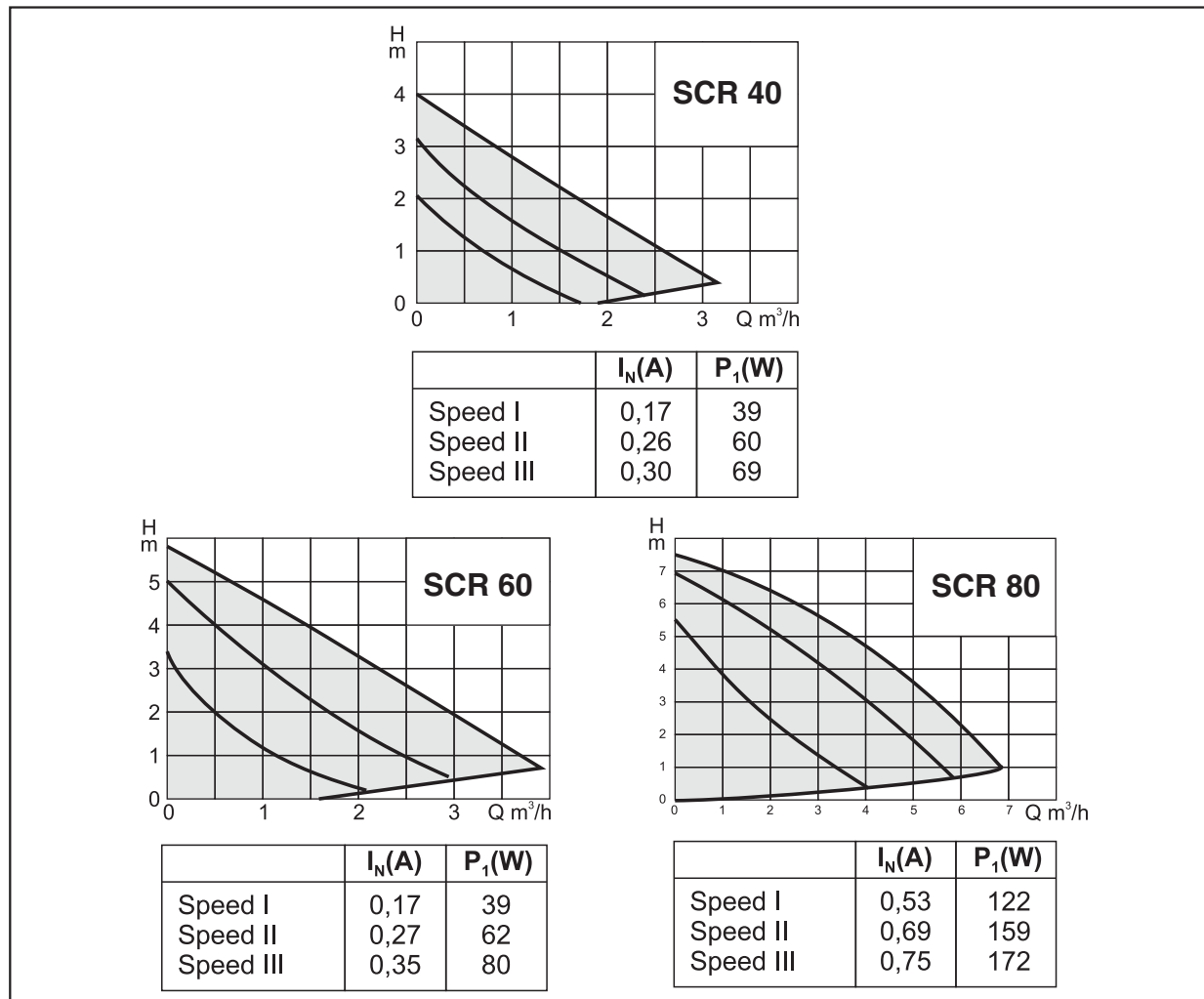



## Dimension illustration

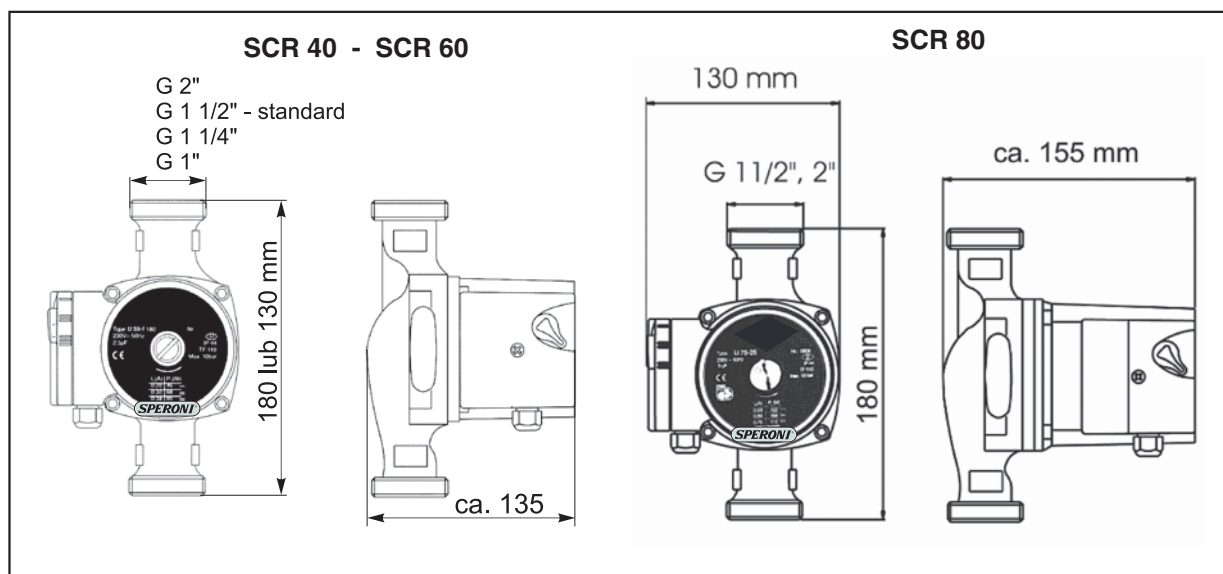

### SCR 40

Article	Pump body	Length (mm)	DN	External thread	H(m)	Power consumption (W)
SCR 25/40-180	Cast iron	180	25	G 1 1/2 "	4	28-63
SCR 15/40-130	Cast iron	130	15	G 1 "	4	28-63
SCR 20/40-130	Cast iron	130	20	G 1 1/4"	4	28-63
SCR 25/40-130	Cast iron	130	25	G 1 1/2"	4	28-63
SCR 20/40-180	Cast iron	180	20	G 1 1/4"	4	28-63
SCR 32/40-180	Cast iron	180	32	G 2 "	4	28-63

### SCR 60

Article	Pump body	Length (mm)	DN	External thread	H(m)	Power consumption (W)
SCR 25/60-180	Cast iron	180	25	G 1 1/2 "	6	39-80
SCR 15/60-130	Cast iron	130	15	G 1 "	6	39-80
SCR 20/60-130	Cast iron	130	20	G 1 1/4"	6	39-80
SCR 25/60-130	Cast iron	130	25	G 1 1/2"	6	39-80
SCR 20/60-180	Cast iron	180	20	G 1 1/4"	6	39-80
SCR 32/60-180	Cast iron	180	32	G 2 "	6	39-80

### SCR 80

Article	Pump body	Length (mm)	DN	External thread	H(m)	Power consumption (W)
SCR 25/80-130	Cast iron	130	25	G 1 1/2 "	8	122-170
SCR 32/80-130	Cast iron	130	32	G 2 "	8	122-170
SCR 25/80-180	Cast iron	180	25	G 1 1/2 "	8	122-170
SCR 32/80-180	Cast iron	180	32	G 2 "	8	122-170

## Energy-saving Speroni SCRE 40 - SCRE 60 electronic circulation pumps for central heating

Along with the series Delta plus we have achieved a circulation pump which is classified in energy efficiency class "A". Using a Speroni pump instead of a conventional circulation pump helps to reduce energy consumption up to 80%, while keeping the hydraulic power at a comparable level. The "One touch" option allows you to choose from six different performance curves.

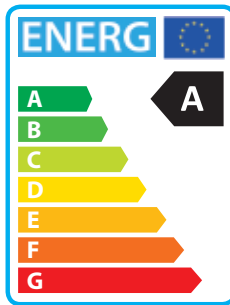

### Technical data

	<b>SCRE 40</b>	<b>SCRE 60</b>
max. lifting height:	4.0	6.0
max. flow:	2600 l/h	3200 l/h
power consumption (W):	3-23	3-38
electronically regulated power:	adjusted to the actual energy demand of the installation	
operating voltage:	1x230V, 50 Hz	
motor protection:	external protection is not required	
protection type:	IP 44	
insulation class:	F	
ambient temperature:	0°C to 40°C	
media temperature:	5°C to 95°C	
temperature class:	TF 95	
max. operating pressure:	10 bar	
connection:	DN15, DN20, DN25, DN32	
installation length:	130 mm, 180 mm	
weight:	about 2.40 kg	

### pumps performance curves

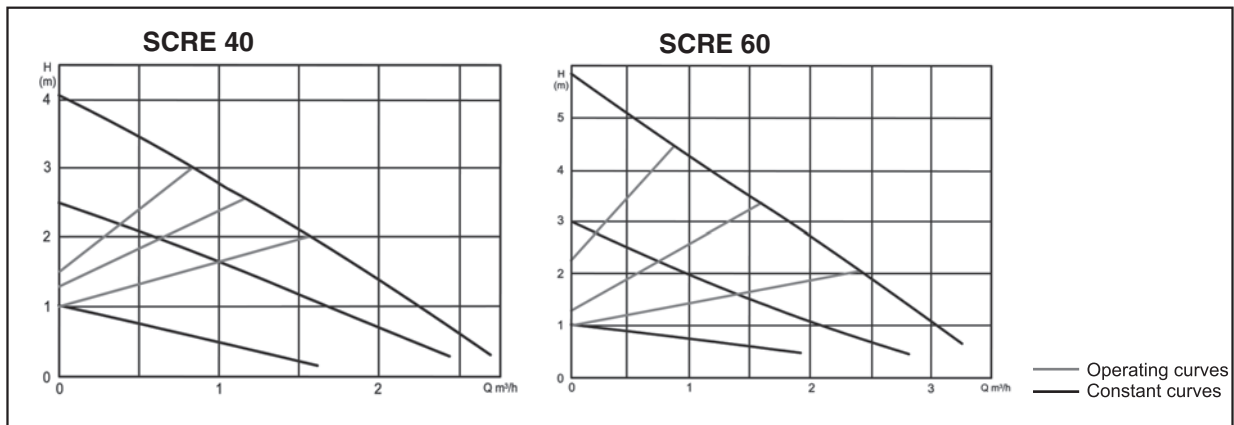

## Performance curve models

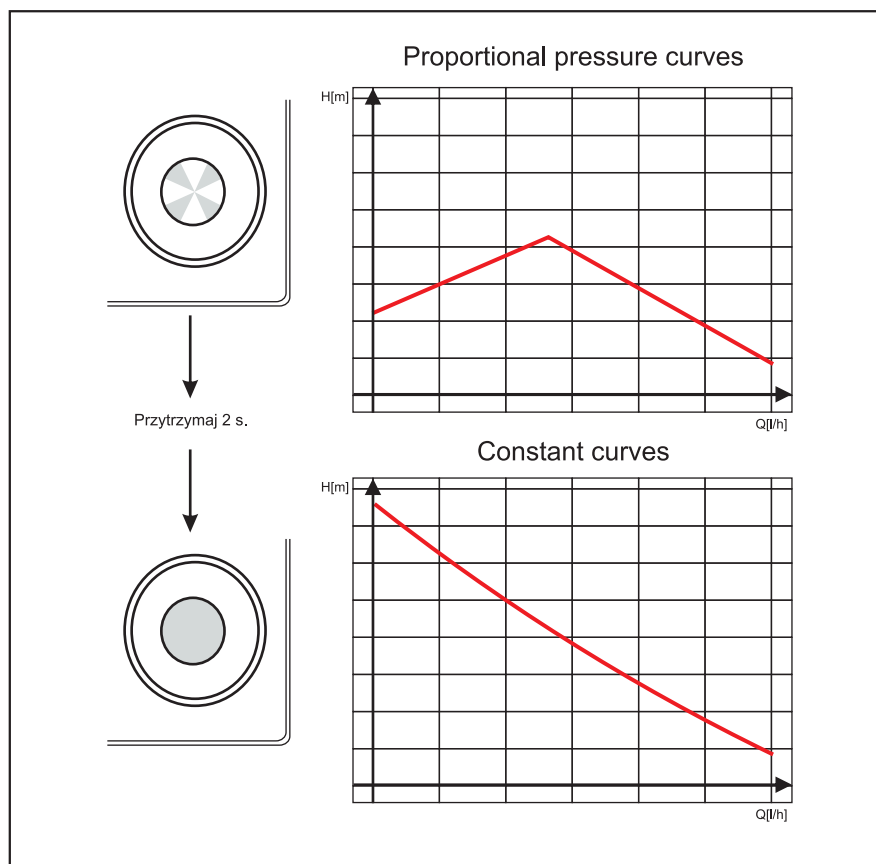

## SCRE

Article	Pump body	Length (mm)	DN	External thread	H(m)	Power consumption (W)
SCRE 25/40-180	Cast iron	180	25	G 1 1/2 "	4	3-23
SCRE 32/40-180	Cast iron	180	32	G 2"	4	3-23
SCRE 25/60-180	Cast iron	180	25	G 1 1/2"	6	3-38
SCRE 32/60-180	Cast iron	180	32	G 2"	6	3-38

**Energy-saving Speroni SCRE PLUS 40 - SCRE PLUS 60 electronic circulation pumps for central heating**

Along with the series Delta HE we have achieved a circulation pump which is classified in energy efficiency class "A". Using a Speroni pump instead of a conventional circulation pump helps to reduce energy consumption up to 80%, while keeping the hydraulic power at a comparable level. The "One touch" option allows you to choose from seven different performance curves.

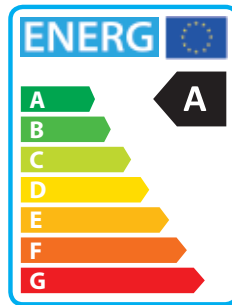

**Technical data**

	<b>SCRE PLUS 40</b>	<b>SCRE PLUS 60</b>
max. lifting height:	4.0 m	6.0 m
max. flow:	2600 l/h	3200 l/h
power consumption (W):	3-23	3-38
electronically regulated power:	adjusted to the actual energy demand of the installation	
operating voltage:	1x230V, 50 Hz	
motor protection:	external protection is not required	
protection type:	IP 44	
insulation class:	F	
ambient temperature:	0°C to 40°C	
media temperature:	5°C to 95°C	
temperature class:	TF 95	
max. operating pressure:	10 bar	
connection:	DN15, DN20, DN25, DN32	
installation length:	130 mm, 180 mm	
weight:	about 2.40 kg	

pumps performance curves

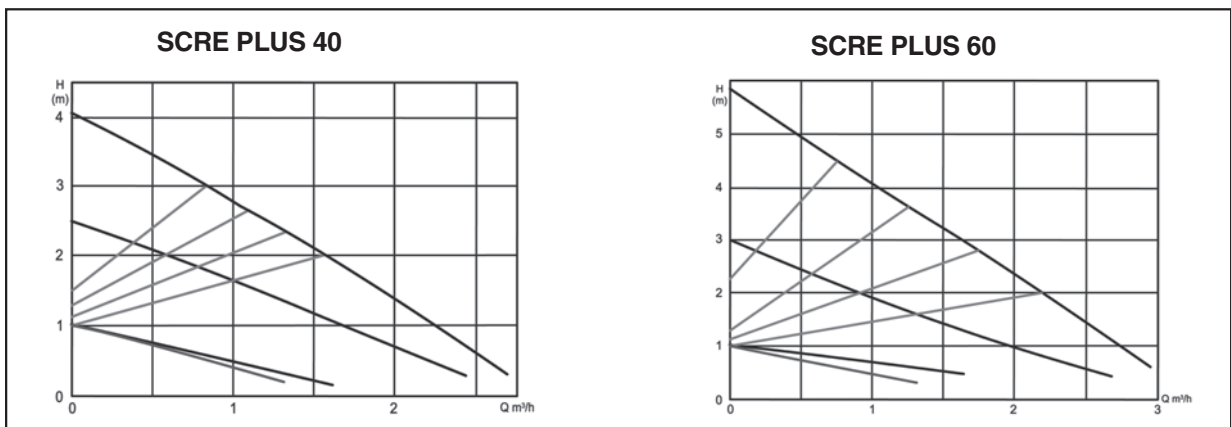

## Display settings

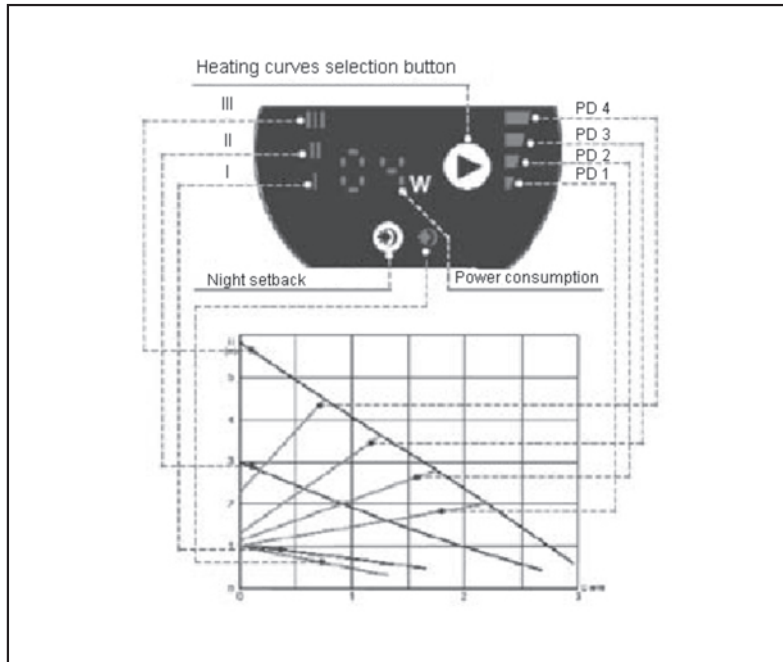

## The display



The display is lit when pump is plugged in. The LED display shows the current power consumption.

Faults are shown on the display as "E1", "E2" or "E3" errors. When the night setback function is activated and the pump is switching to this mode, then the "-C" symbol appears on the display.

## Curve selection button



By pressing the button pump settings change. Pressing the button seven times causes to select one by one all the options and then return to the first one.

Display	Description
I	constant rotation speed I
II	constant rotation speed II
III	constant rotation speed III
PD1	low curve of proportional pressure
PD2	second curve of proportional pressure
PD3	third curve of proportional pressure
PD4	high curve of proportional pressure

## Night setback button



Pressing the button activates the automatic night setback function, which is also shown on the display. Pressing and holding the button for 5 seconds activates the function permanently, and therefore "-C" appears on the display. Pressing the button again deactivates the function.

# SCRE PLUS

## Pump settings

Regulation of proportional pressure

When operating the pump adjusts to the settings of proportional pressure. Whereas differential pressure is controlled by the pump, depending on the current of the flow.

Lines (characteristics) of proportional pressure are denoted with PD1 to PD4 symbols on corresponding Q/H graphs.

Constant rotation speed control

Lines (characteristics) of constant speed rotation are denoted with I to III symbols on the Q/H graph. This type of control allows the pump to maintain constant rotation speed.

## Automatic night setback

The requirements for night setback temperature reduction



**In no case the night setback function should be activated in pumps built in gas fired boilers with a small amount of water.**

### Tip

If the heating device does not impart enough heat to the radiators, check whether the automatic night setback function is not activated. If this is the case, the function should be deactivated.

In order to guarantee proper functioning of the night setback function, the following conditions must be met:

1. The pump must be mounted on the water inlet.
2. The heating device has to be equipped with an automatic supply temperature control.

## How night setback function works

In order to activate the night setback function press  button. When the display lights, it means the function is activated and the pump is switching automatically from the standard mode to the night setback function. The switchover depends on the water supply temperature. The pump switches automatically to the night setback mode, if the water supply temperature drops more than 10° - 15°C within an hour. Consequently, the "-C" symbol appears on the display. The pump immediately switches to the standard mode when the water supply temperature increases 3°C.

## Night setback

The function can be activated permanently. After activating the night setback function the  button has to be pressed during 5 seconds.

The "-C" symbol displays after releasing the button. Until the button is pressed again, the pump will remain in the chosen mode.

### SCRE PLUS

Article	Pump body	Length (mm)	DN	External thread	H(m)	Power consumption (W)
SCRE PLUS 25/40-180	Cast iron	180	25	G 1 1/2 "	4	3-23
SCRE PLUS 32/40-180	Cast iron	180	32	G 2"	4	3-23
SCRE PLUS 25/60-180	Cast iron	180	25	G 1 1/2"	6	3-38

# SCRSE 15/15-65

## ELECTRONIC SAVING CIRCULATION PUMPS

### Energy-saving d.h.w. SCRSE 15/15-65 circulation pumps

#### SPHERICAL MOTOR SOLUTION

Circulation pumps are installed in domestic hot water circulation installations.

Thanks to the circulation process, hot water is available in any room immediately after opening the faucet. SCRSE 15/15-65 pumps have been designed to be used at single family and multi-family houses. Thanks to domestic hot water circulation the water consumption is considerably reduced.

Circulation pumps are first of their kind which run on 8 W only. In comparison with conventional pumps energy consumption is reduced by 68%. It became possible thanks to the combination of a spherical motor and ECM technology (Electronically Commutated Motor). Domestic hot water circulation pumps are high-efficiency pumps. Thanks to the ECM technology you can save energy while maintaining the same power. The secret of improved efficiency is the spherical magnet rotor. Instead of being initiated each time, the magnetic field of the rotor is present in the pump since the very beginning.

A microprocessor located in the pump initiates variable frequency magnetic field inside stator coils, which sets the rotor in motion. The starting torque, and consequently the safety of users, has improved in comparison with conventional pumps.

ONLY 8W!

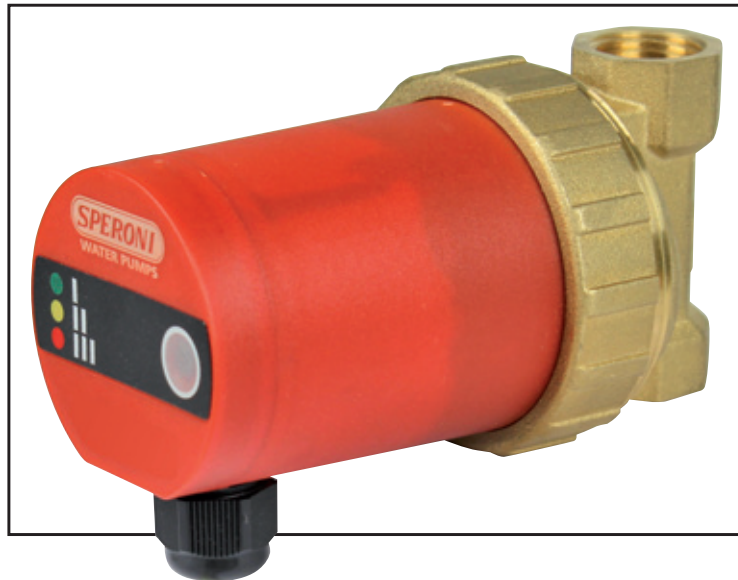

#### Construction of SCRSE 15/15-65 circulation pump

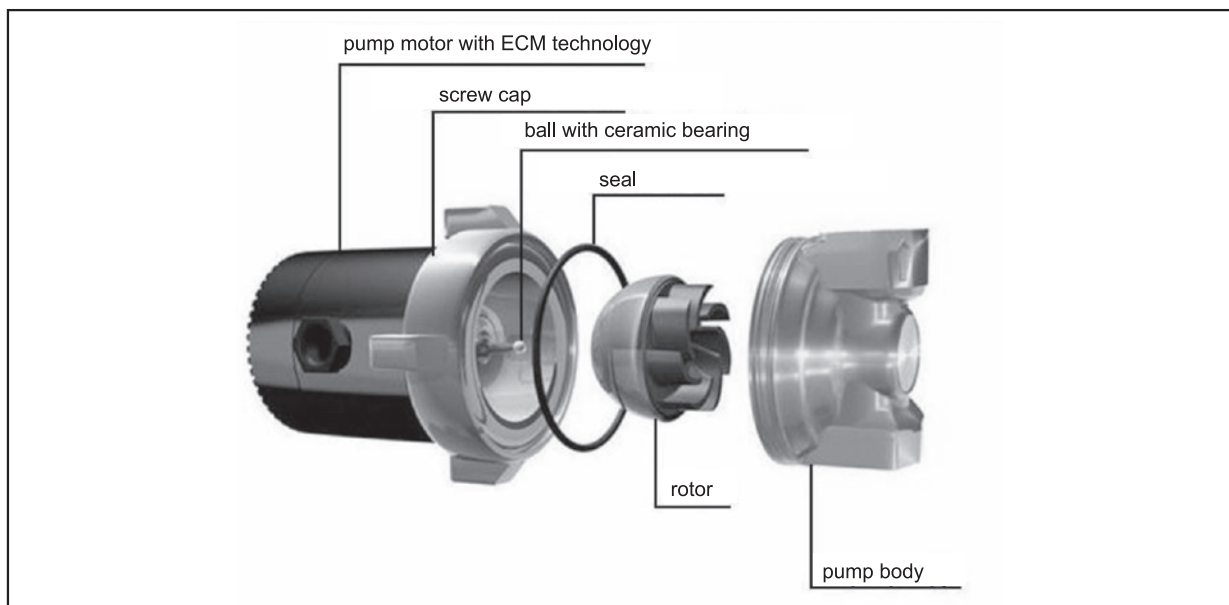

**Pump marking**

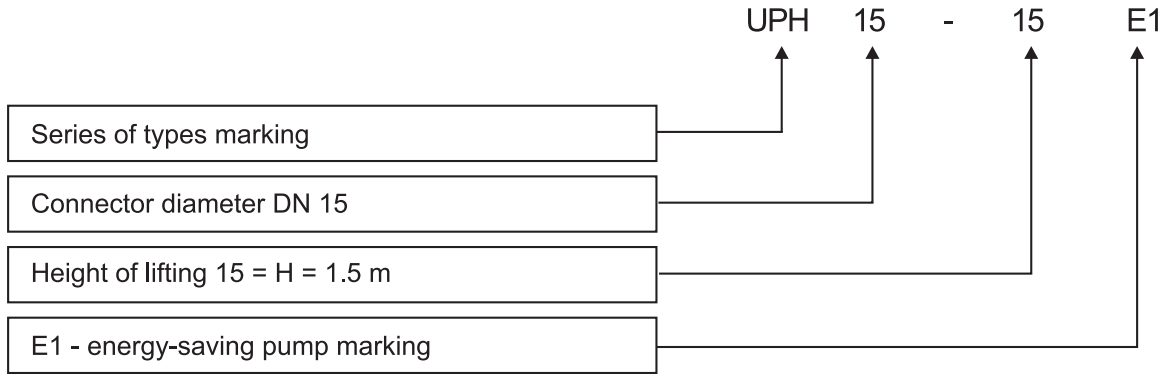

**Pump mounting**

The pump has to be mounted on a circulation pipe, preferably just before the boiler / d.h.w. tank, so that the water from the last place can be pumped again.

The check valve **has to be** mounted behind the pump (on the delivery side). This prevents the water from going back to the pump. Whereas the ball valve should be mounted on the suction side in order to make maintenance easier.

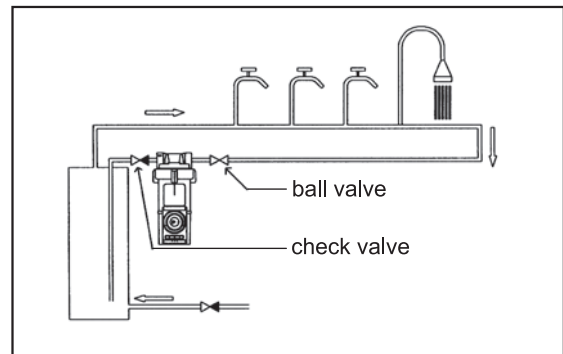

**Pump mounting permissible ways**

The pump must be mounted in a way, so that the pumping is turned **upwards or horizontal** (at the same time the pump motor has to be turned downwards). Possible ways of mounting are shown on the following figures. Each pump has to be vented before start-up. In order to vent the pump you need to use the brass nut, which joins the pump body with the motor.

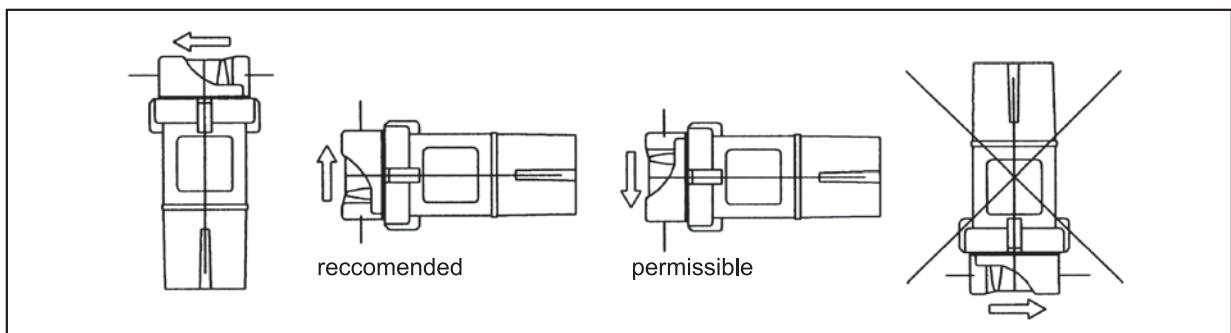



# SCRSE 15/15-65

## Technical data

### Pump

medium: water  
 max. lifting height: 12 kPa  
 max. flow: 0.95 m<sup>3</sup>/h  
 max. pressure: 10 bar  
 operating temperature: -10°C to 110°C  
 connection: R 1/2" GW  
 installation length: 65 mm

### Pump motor

motor type: ECM spherical magnet rotor  
 operating voltage: 230V, 50Hz  
 power consumption: 8 W  
 protection type: IP44/F

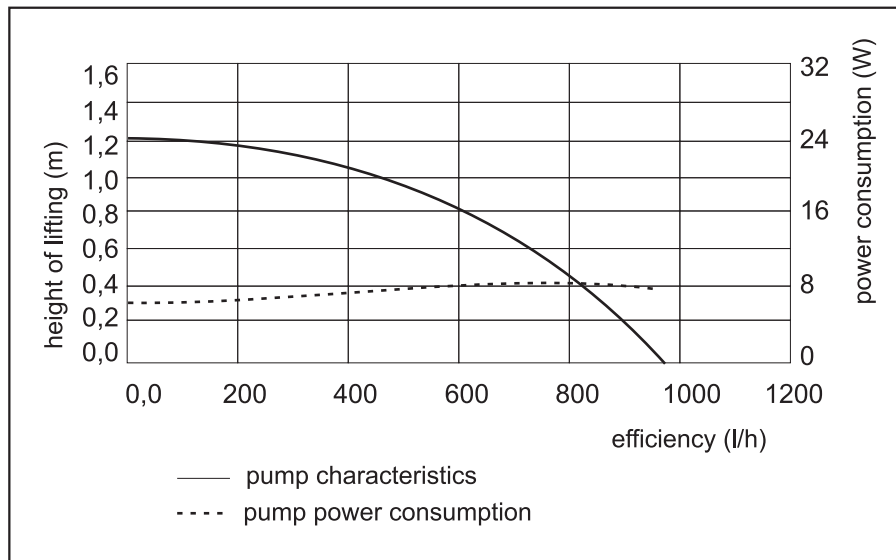

## Dimension illustration

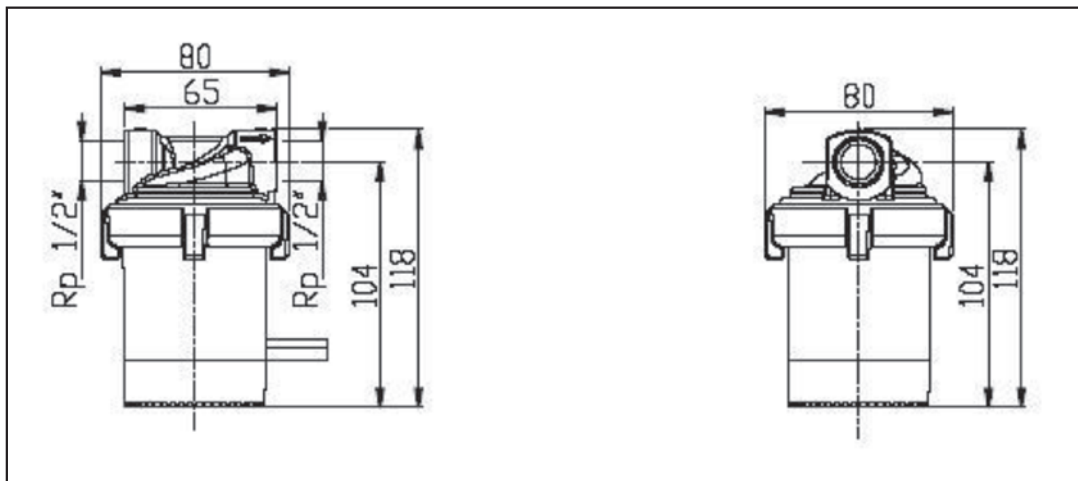

### SCRSE 15/15-65

Pump type	Connection	Length Pumps [mm]	Dry-running protection	Safety thermostat 55°C	Safety thermostat regulated
SCRSE 15/15-65	1/2" GW	65	.		



**Applications**

The SPERONI SCRS circulators for sanitary warm water are conceived for the water circulation inside the distributing system.

The technical adopted solutions allow the solving of specific plant problems without changing the water quality.

**Limits of application**

- Pressure rating 5,5 bar
- Working max pressure NP 10bar
- Delivery 3,5m/h
- Temperature liquid up to 110° C
- Recommended temperature 65° C
- Continuous service

**Motor**

- Electric motor
- Isolation class F
- Protection IP 44

**Components**

- Pumps body in bronze
- Synthetic Impeller (polymer)
- Shaft in ceramics
- Ball bearing in ceramics
- Trust bearing
- Rotor with Stainless steel housing
- Winding copper wire
- Gasket in EPDM

**DIMENSIONS AND WEIGHTS**

TYPE	DN	D1	D2	L1	B1	B2	H2	Kg
SCRS 20/40-110	20	3/4"	1"1/4	110	84	43	117	2,3
SCRS 20/60-110	20	3/4"	1"1/4	110	84	43	117	2,3
SCRS 25/40-110	25	1"	1"1/2	110	84	43	117	2,3
SCRS 25/60-110	25	1"	1"1/2	110	84	43	117	2,3
SCRS 20/40-130	20	3/4"	1"1/4	130	84	43	117	2,4
SCRS 20/60-130	20	3/4"	1"1/4	130	84	43	117	2,4
SCRS 25/40-130	25	1"	1"1/2	130	84	43	117	2,4
SCRS 25/60-130	25	1"	1"1/2	130	84	43	117	2,4

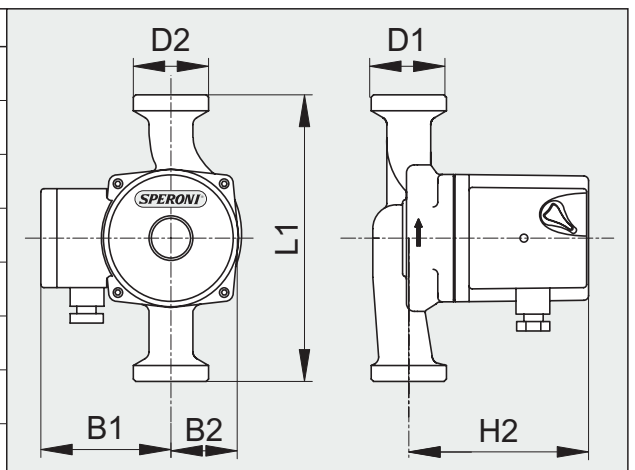

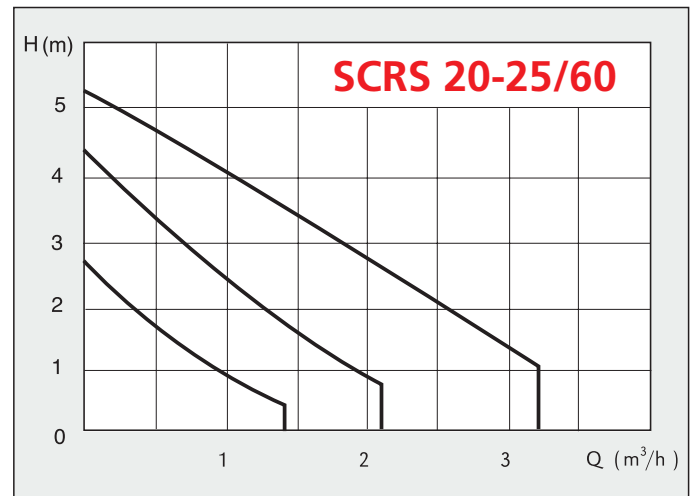
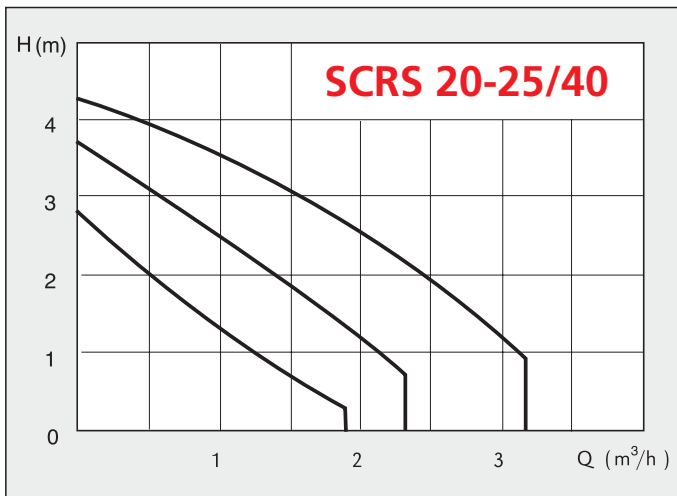

Type	DN	Pos.	(min-1)	P1 (W)	1x230 V (A)
SCRS 20/40-110	20	1	1315	39	0,17
		2	1723	60	0,26
		3	2456	69	0,30
SCRS 20/60-110	20	1	1080	39	0,17
		2	1396	62	0,27
		3	1980	80	0,35
SCRS 25/40-110	25	1	1315	39	0,17
		2	1723	60	0,26
		3	2456	69	0,30
SCRS 25/60-110	25	1	1080	39	0,17
		2	1396	62	0,27
		3	1980	80	0,35
SCRS 20/40-130	20	1	1315	39	0,17
		2	1723	60	0,26
		3	2456	69	0,30
SCRS 20/60-130	20	1	1080	39	0,17
		2	1396	62	0,27
		3	1980	80	0,35
SCRS 25/40-130	25	1	1315	39	0,17
		2	1723	60	0,26
		3	2456	69	0,30
SCRS 25/60-130	25	1	1080	39	0,17
		2	1396	62	0,27
		3	1980	80	0,35

## ACCESSORIES

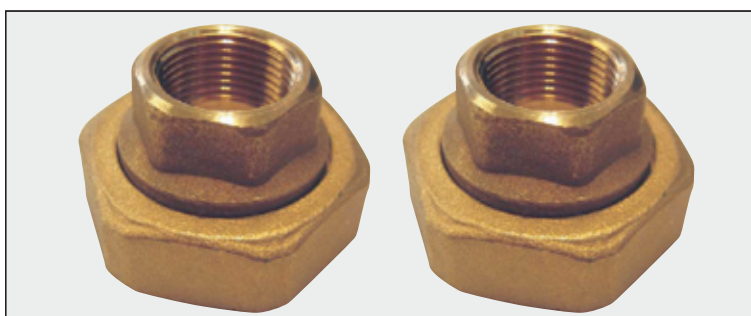

Set raccordi circolatore bronzo SCRS 15 1/2"x1"

Set raccordi circolatore bronzo SCRS 20 3/4"x1 1/4"

Set raccordi circolatore bronzo SCRS 25 1"x1 1/2"

# SCRF

## Applications

The SPERONI SCRF circulators for clean liquids, without abrasives, which are non-aggressive for the pump materials (contents of solids up to 0.2%). For heating, conditioning, cooling and circulation plants. For civil and industrial applications. When low noise operation is required.

## Limits of application

- Liquid temperature from -10 °C to +120 °C (in short-time duty up to + 140 °C).
- Ambient temperature up to 40 °C.
- Maximum glycol quantity: 50% (Mixture with more than 20% glycol content require rechecking of the pumping data).
- Maximum permissible working pressure 6/10 bar.

## Motor

- 2/4 pole induction motor, 50 Hz.
- Three adjustable speeds.
- SCRF: three-phase 230V or 400 V.
- Insulation class F.
- Protection IP 43.

## Components

- Pump casing Cast iron
- Impeller Stainless steel
- Shaft Stainless steel

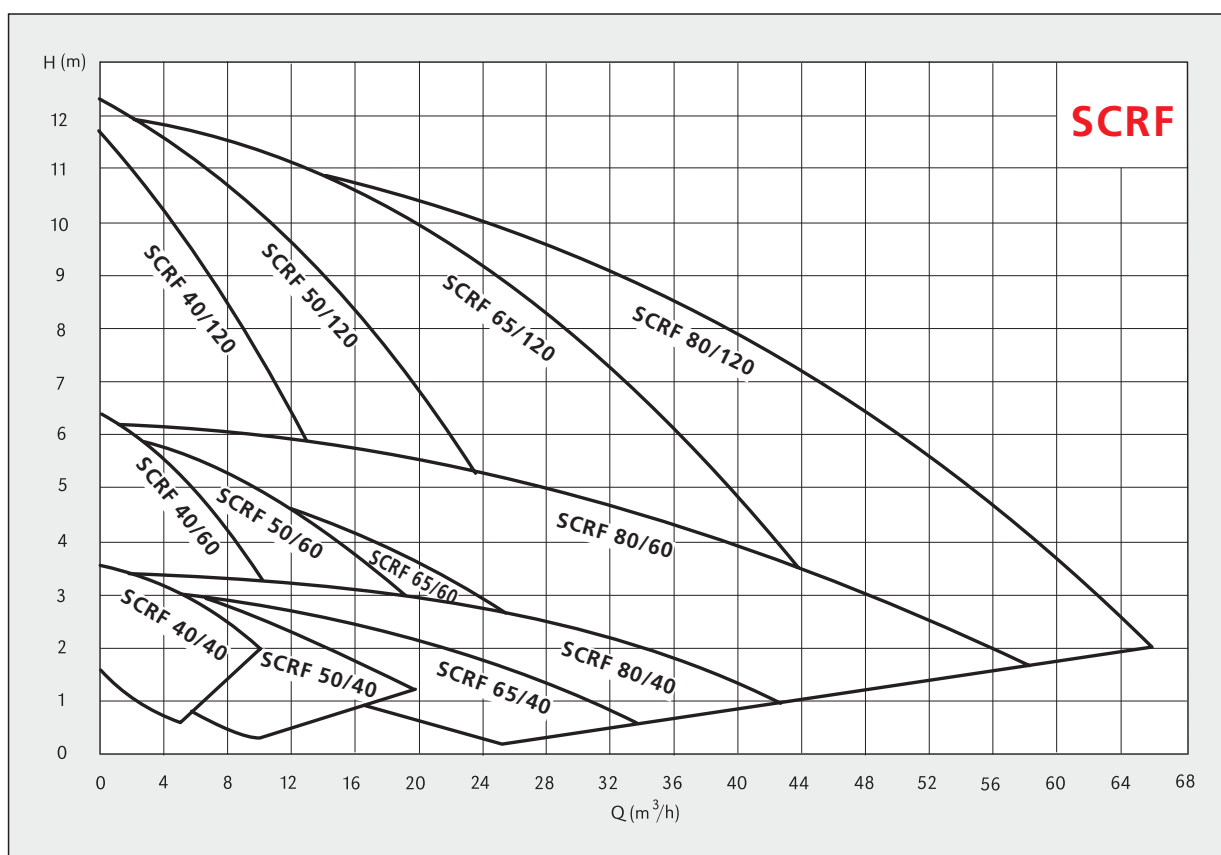

# SCRF 40

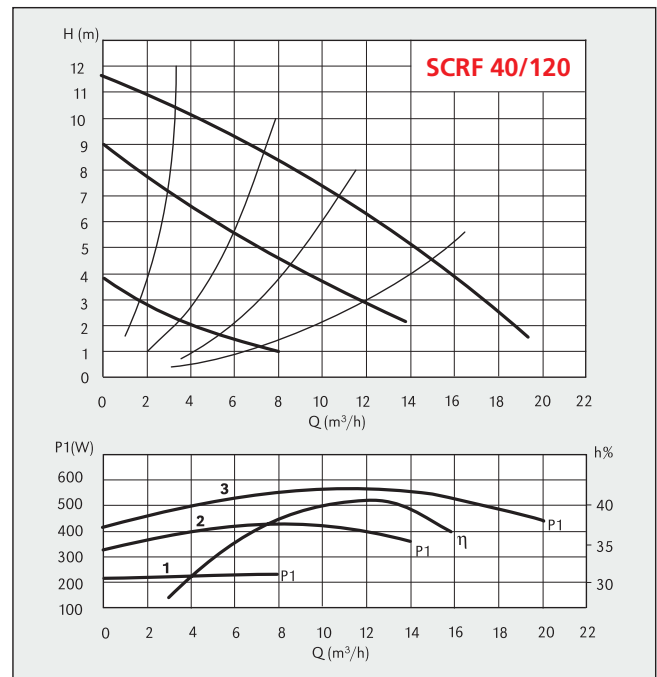
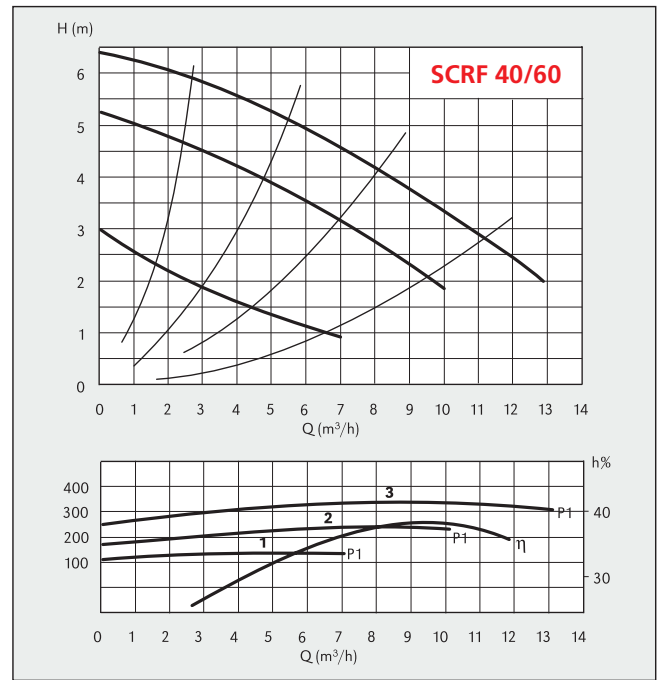
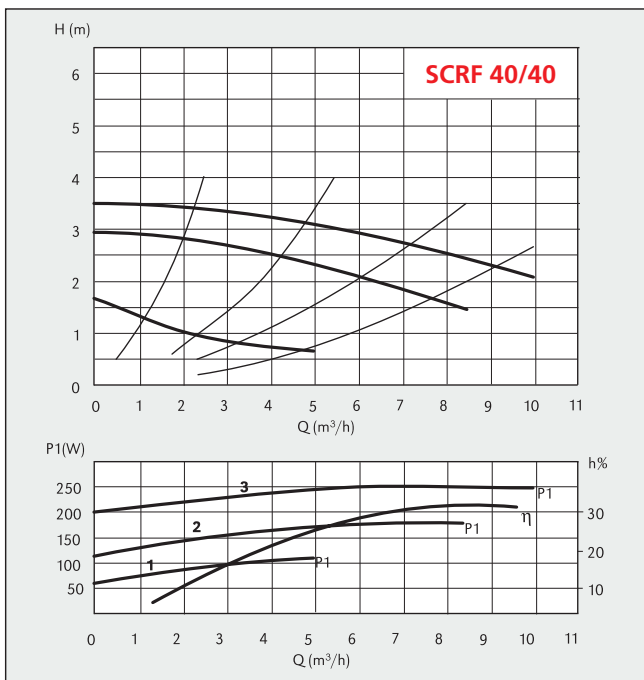

## DIMENSIONS AND WEIGHTS

TYPE	DN	N° Pole		Pos.	1/min	P1 (W)	3x 400 V [A]	[kg]
		2	4					
SCRF 40-40/250	40	✓		3	1440	240	0,76	17,0
				2	1200	160	0,24	
				1	660	100	0,11	
SCRF 40-60/250	40	✓		3	2790	320	0,74	17,5
				2	2240	240	0,36	
				1	1440	140	0,18	
SCRF 40-120/250	40	✓		3	2820	560	1,16	19,0
				2	2200	400	0,64	
				1	1250	220	0,26	

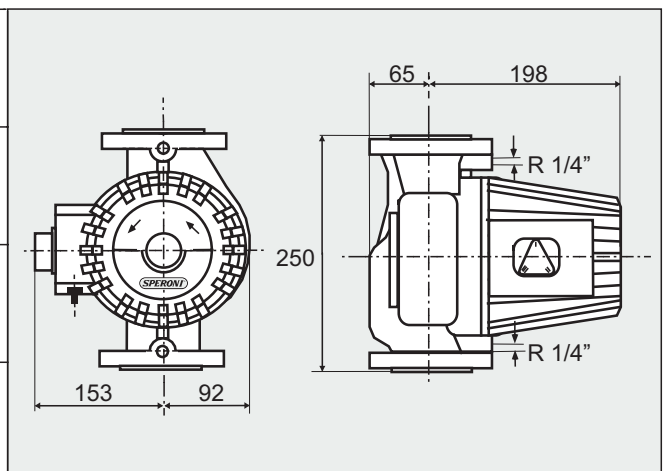

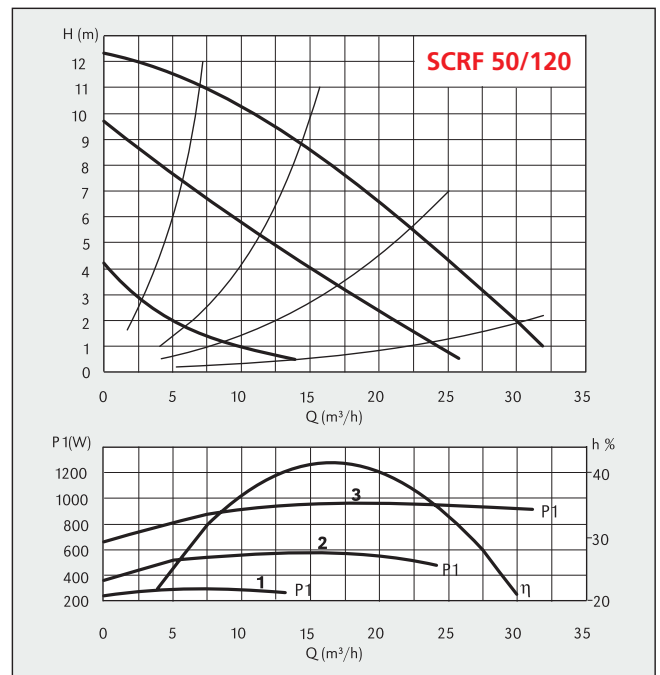
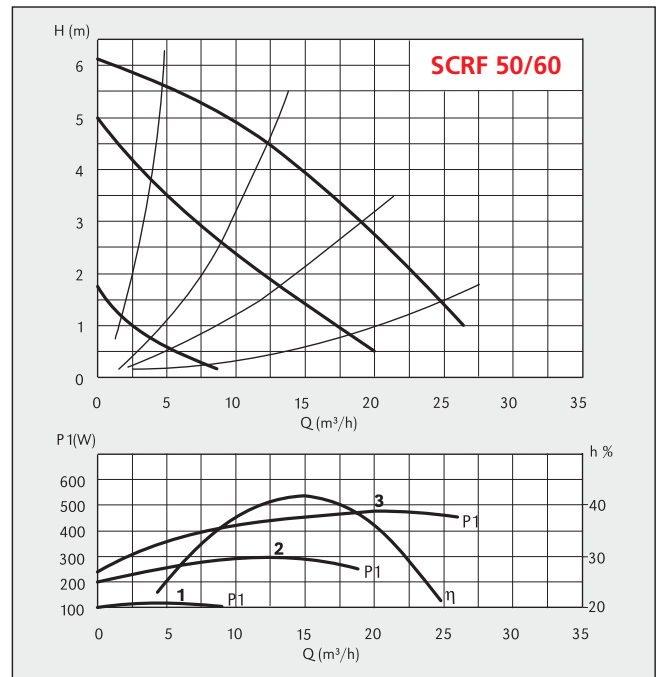
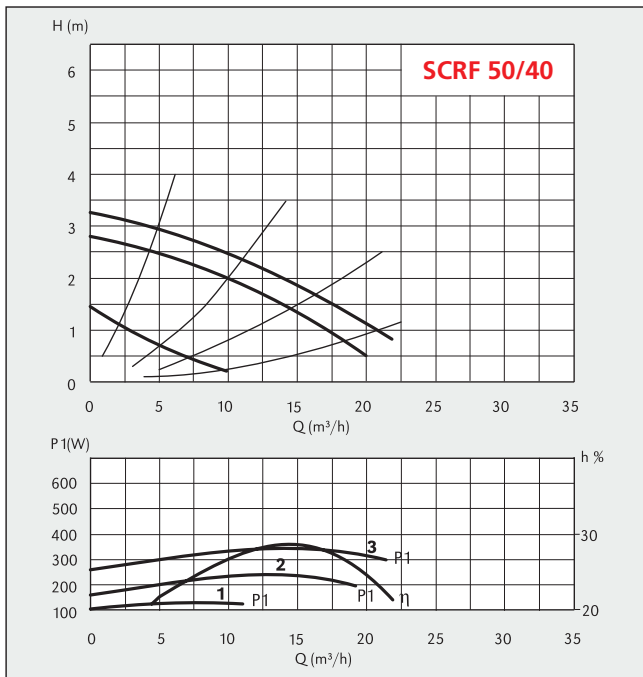

## DIMENSIONS AND WEIGHTS

TYPE	DN	N° Pole		Pos.	1/min	P1 (W)	3x 400 V [A]	[kg]
		2	4					
SCR 50-40/280	50	✓		3	1450	340	1,05	24,0
				2	1220	240	0,44	
				1	620	120	0,22	
SCR 50-60/280	50	✓		3	1400	470	1,15	24,0
				2	1000	300	0,55	
				1	560	100	0,20	
SCR 50-120/280	50	✓		3	2800	950	1,73	24,0
				2	2330	540	1,05	
				1	1270	265	0,46	

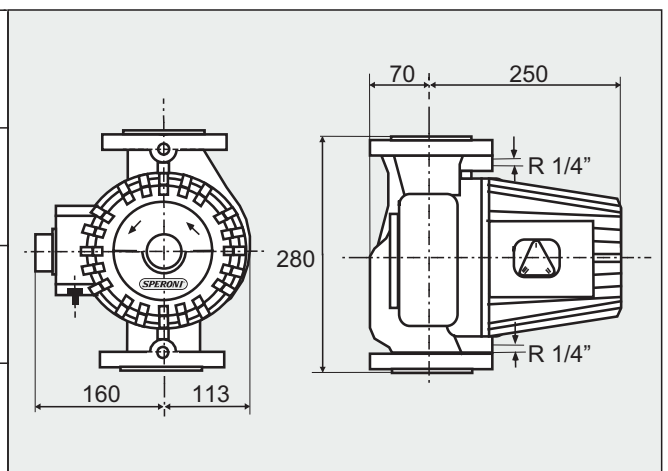

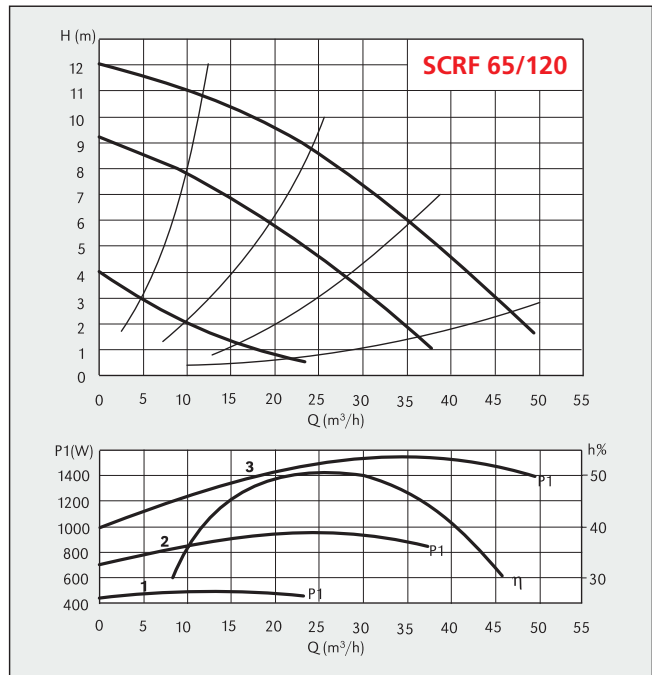
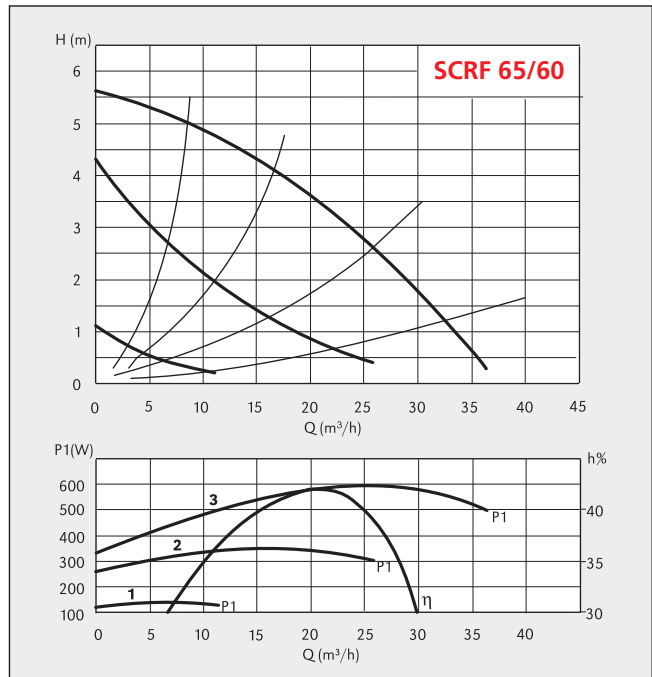
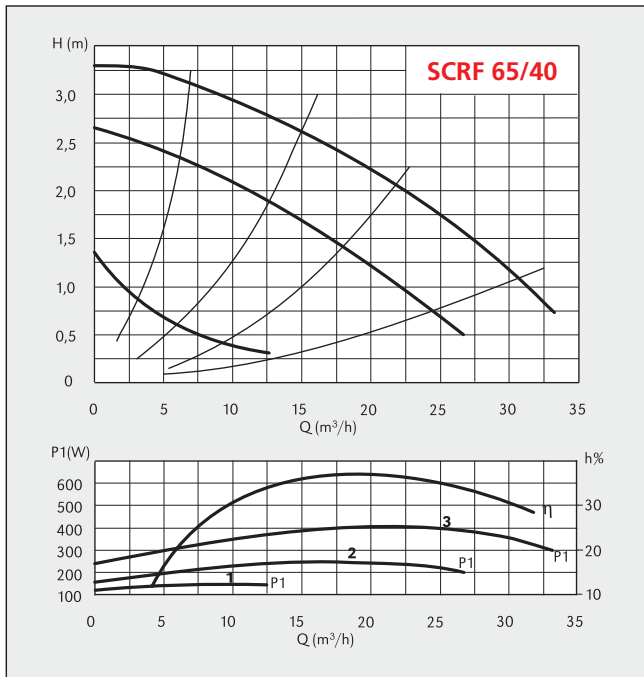

## DIMENSIONS AND WEIGHTS

TYPE	DN	N° Pole		Pos.	1/min	P1 (W)	3x 400 V [A]	[kg]
		2	4					
SCRf 65-40/340	65	✓	3	1430	400	1,10	29,0	
			2	1150	260	0,50		
			1	600	120	0,22		
SCRf 65-60/340	65	✓	3	1370	600	1,25	29,0	
			2	950	360	0,64		
			1	450	120	0,22		
SCRf 65-120/340	65	✓	3	2810	1560	2,80	31,0	
			2	2200	960	1,70		
			1	1250	460	0,84		

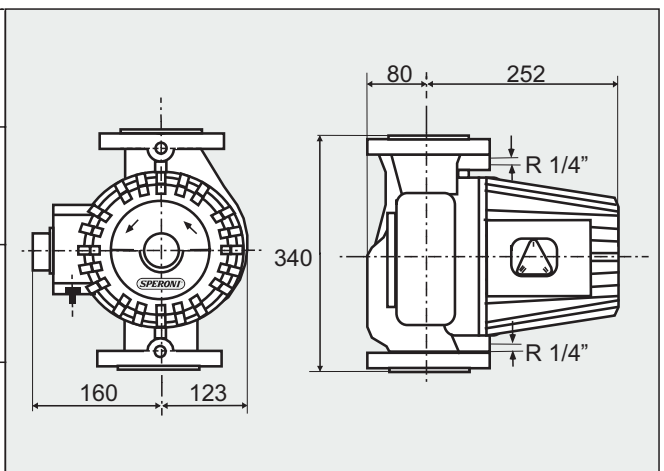

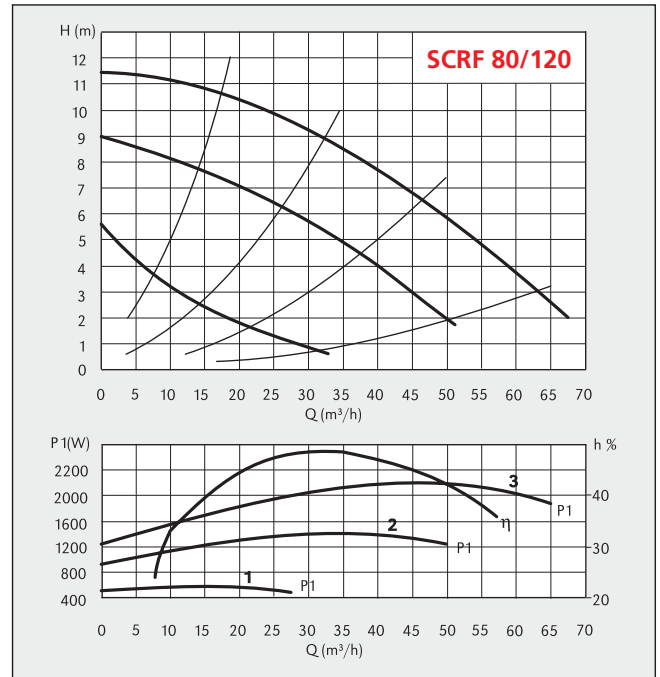
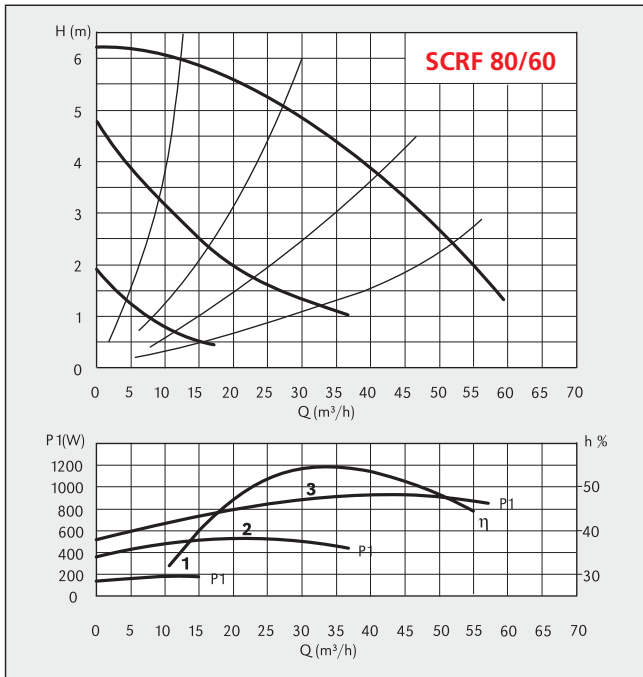

## DIMENSIONS AND WEIGHTS

TYPE	DN	N° Pole		Pos.	1/min	P1 (W)	3x 400 V [A]	[kg]	
		2	4						
SCR 80-60/360	80	✓		3	1350	690	2,20	33,5	
				2	1000	560	1,10		
				1	600	200	0,38		
SCR 80-120/360	80	✓		3	2800	2200	3,80	34,5	
				2	2160	1400	2,40		
				1	1200	550	1,05		



**Applications**

The SPERONI SCRFE circulators for clean liquids, without abrasives, which are non-aggressive for the pump materials (contents of solids up to 0.2%). For heating, conditioning, cooling and circulation plants. For civil and industrial applications. When low noise operation is required.

**Limits of application**

- Liquid temperature from -10 °C to +120 °C (in short-time duty up to + 140 °C).
- Ambient temperature up to 40 °C.
- Maximum glycol quantity: 50% (Mixture with more than 20% glycol content require rechecking of the pumping data).
- Maximum permissible working pressure 6/10 bar.

**Motor**

- 2/4 pole induction motor, 50 Hz.
- Three adjustable speeds.
- SCRFE: single-phase 230 V.
- Insulation class F.
- Protection IP 43.

**Components**

- Pump casing Cast iron
- Impeller Stainless steel
- Shaft Stainless steel

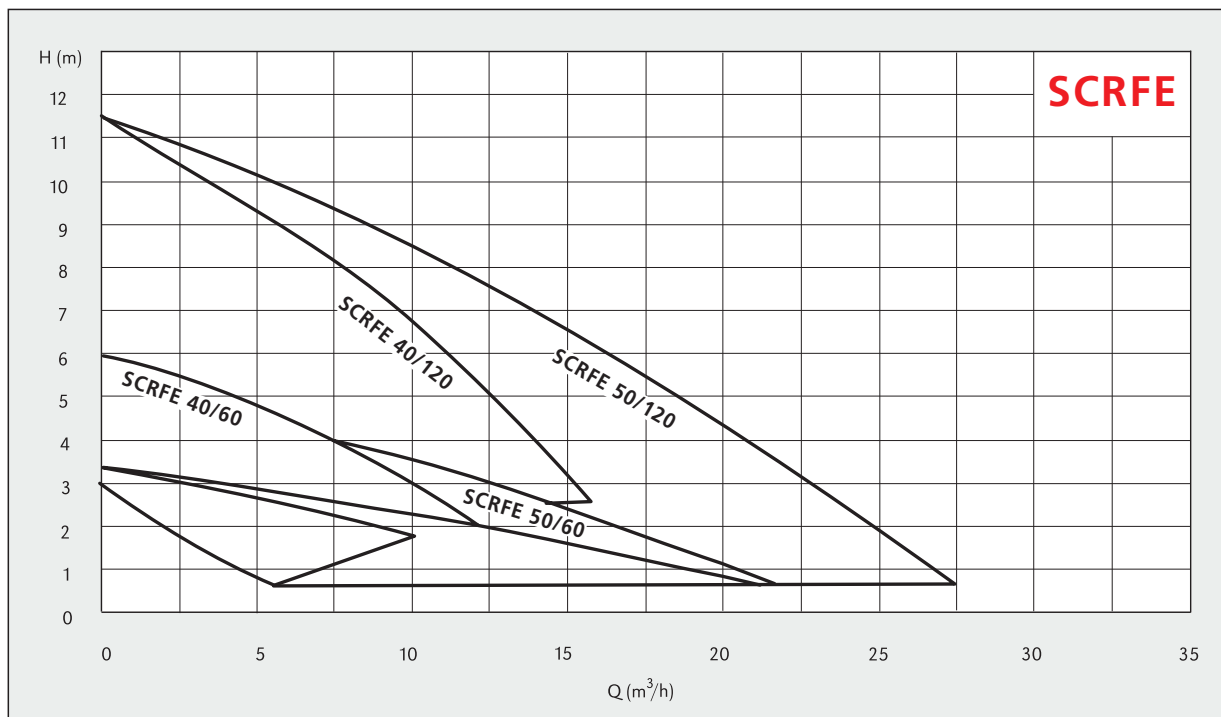

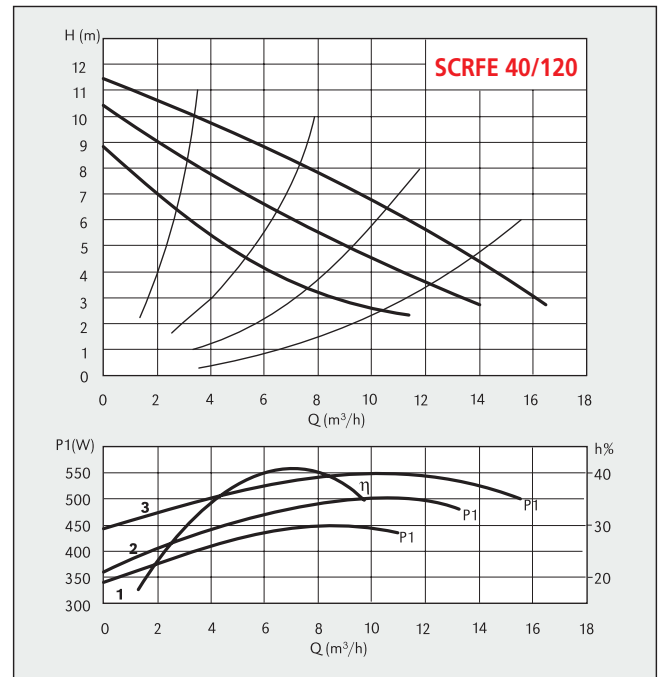
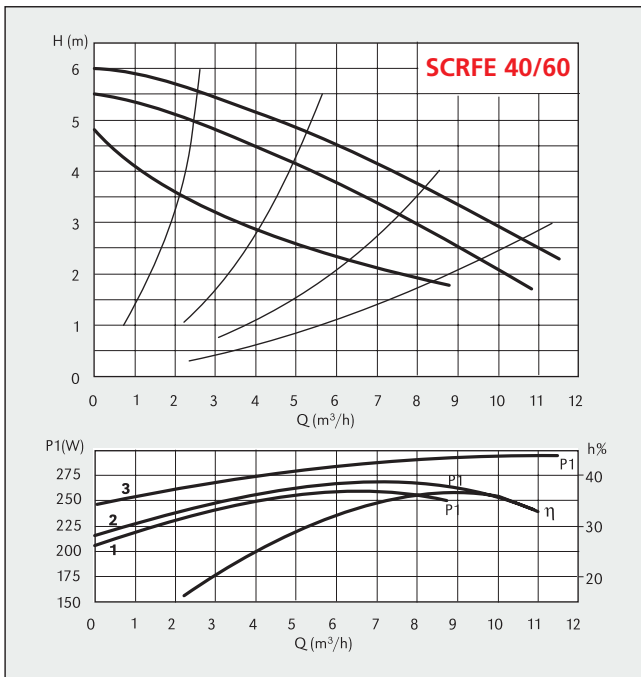

## DIMENSIONS AND WEIGHTS

TYPE	DN	N° Pole		Pos.	1/min	P1 (W)	3x 400 V [A]	[kg]	
		2	4						
SCRFE 40-60/250	40	✓		3	2690	285	1,20	17,5	
				2	2360	245	1,18		
				1	1820	225	1,15		
SCRFE 40-120/250	40	✓		3	2750	550	2,35	19,0	
				2	2100	475	2,30		
				1	1270	355	1,85		

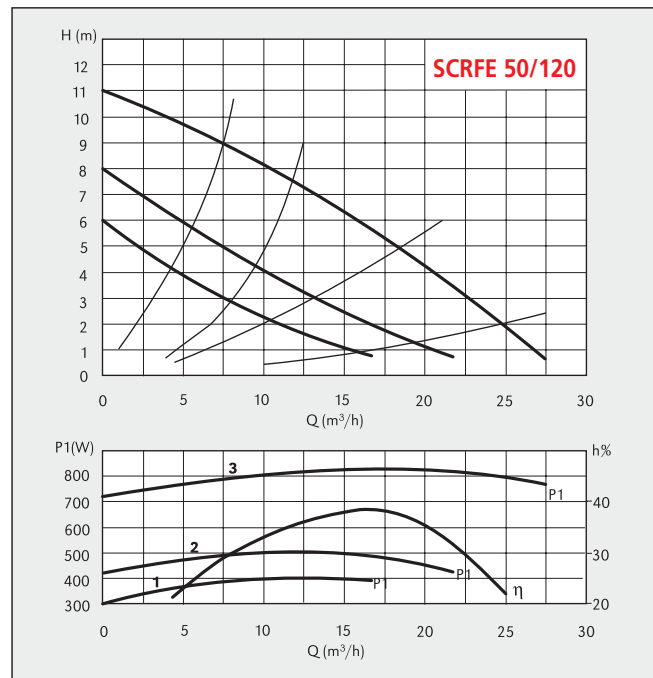
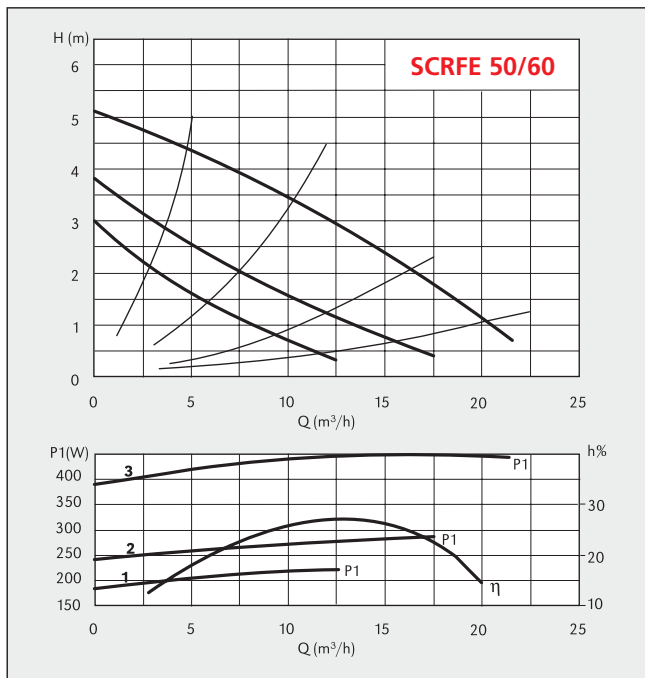

## DIMENSIONS AND WEIGHTS

TYPE	DN	N° Pole		Pos.	1/min	P1 (W)	3x 400 V [A]	[kg]		
		2	4							
SCRFE 50-60/280	50			3	1260	415	1,8	24,5		
			✓	2	1030	300	1,3			
				1	740	230	1,0			
SCRFE 50-120/280	50			3	2720	830	3,6	24,5		
			✓	2	1870	480	2,1			
				1	1450	390	1,7			

# SCRFD

## Applications

The SPERONI SCRFD circulators for clean liquids, without abrasives, which are non-aggressive for the pump materials (contents of solids up to 0.2%). For heating, conditioning, cooling and circulation plants. For civil and industrial applications. When low noise operation is required.

## Limits of application

- Liquid temperature from -10 °C to +120 °C (in short-time duty up to + 140 °C).
- Ambient temperature up to 40 °C.
- Maximum glycol quantity: 50% (Mixture with more than 20% glycol content require rechecking of the pumping data).
- Maximum permissible working pressure 6/10 bar.

## Motor

- 2/4 pole induction motor, 50 Hz.
- Three adjustable speeds.
- SCRFD: three-phase 230V or 400 V.
- Insulation class F.
- Protection IP 43.

## Components

- Pump casing Cast iron
- Impeller Stainless steel
- Shaft Stainless steel

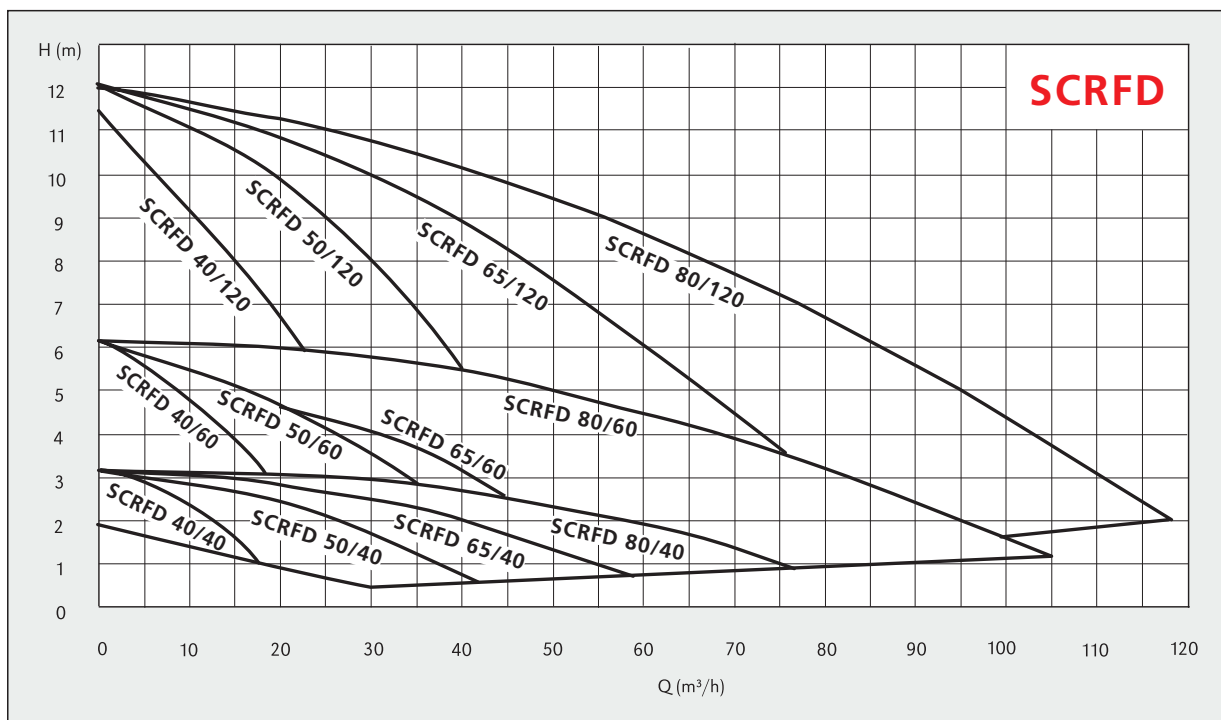

# SCRFD 40

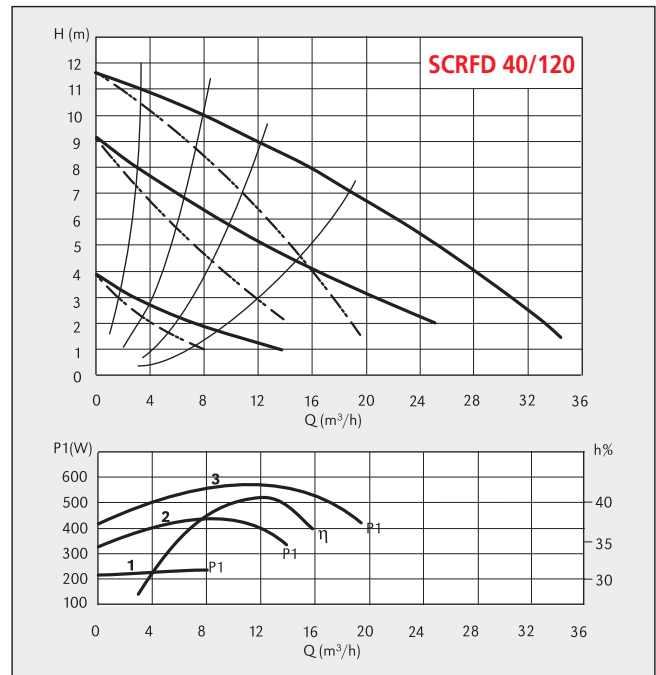
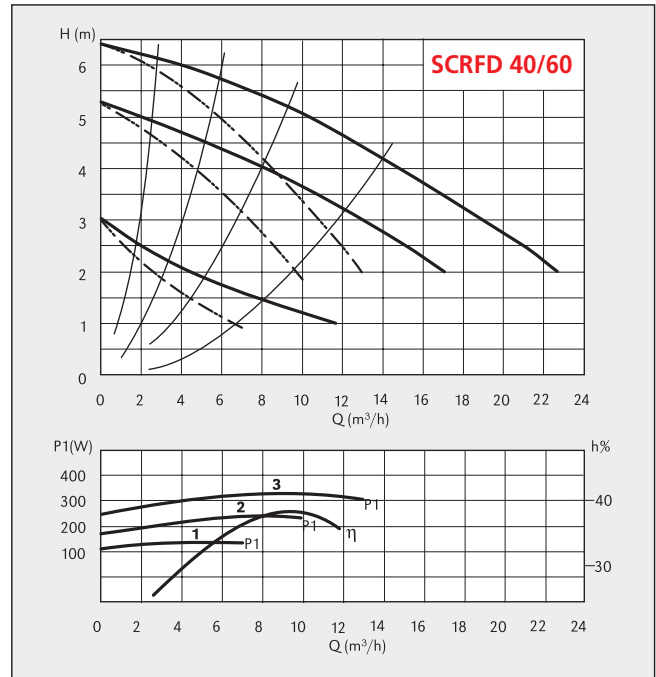
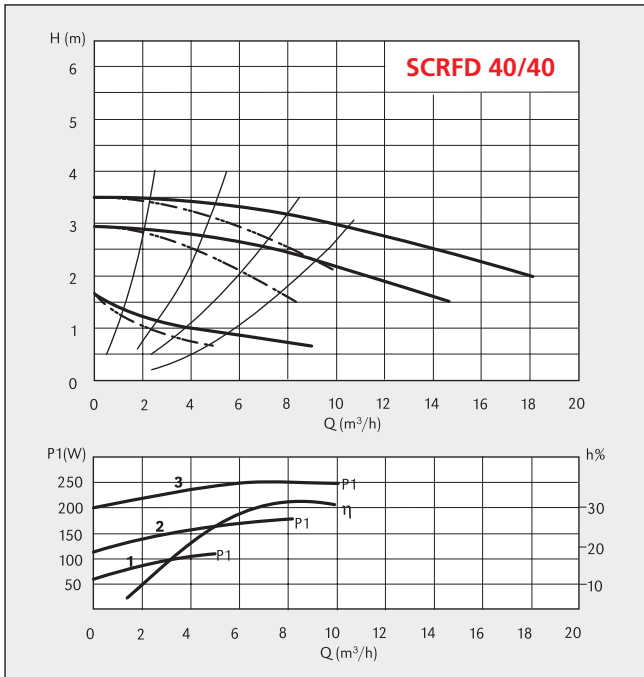

## DIMENSIONS AND WEIGHTS

TYPE	DN	N° Pole		Pos.	1/min	P1 (W)	3x 400 V [A]	[kg]
		2	4					
SCRFD 40-40/250	40	✓		3	1440	240	0,76	34,0
				2	1200	160	0,24	
				1	660	100	0,11	
SCRFD 40-60/250	40	✓		3	2790	320	0,74	35,0
				2	2240	240	0,36	
				1	1440	140	0,18	
SCRFD 40-120/250	40	✓		3	2820	560	1,16	35,0
				2	2200	400	0,64	
				1	1250	220	0,26	

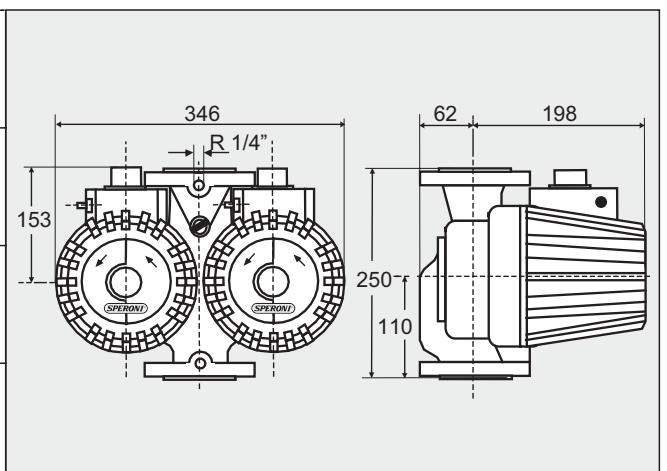

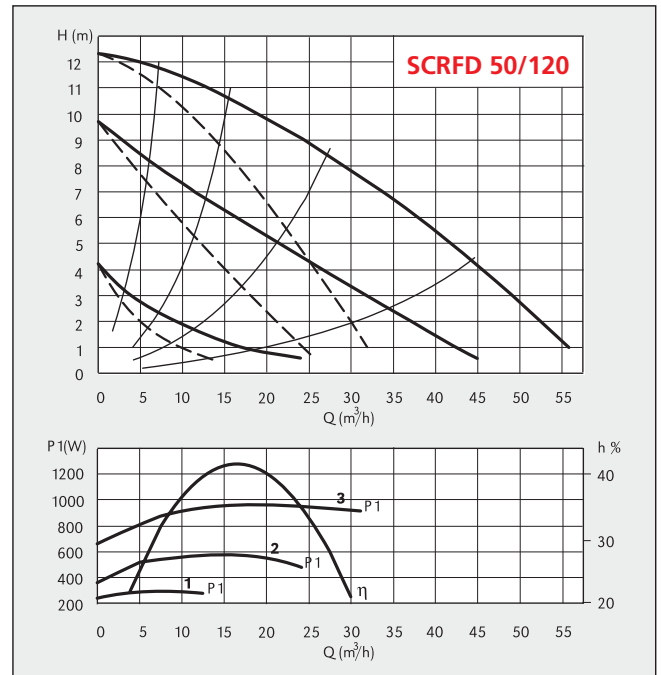
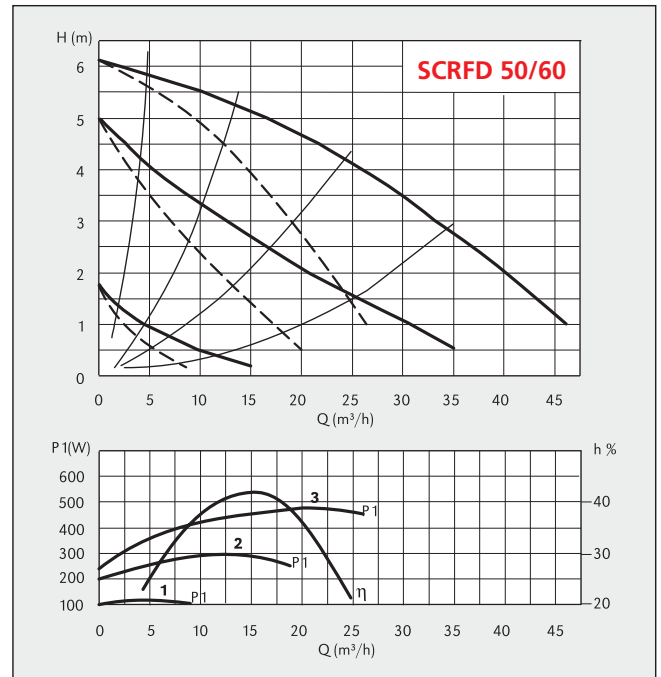
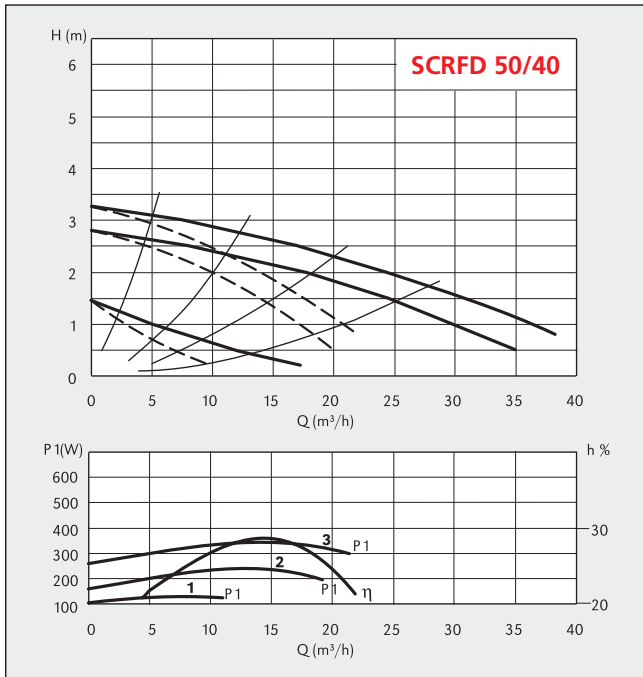

## DIMENSIONS AND WEIGHTS

TYPE	DN	N° Pole		Pos.	1/min	P1 (W)	3x 400 V [A]	[kg]
		2	4					
SCRFD 50-40/280	50	✓		3	1450	340	1,05	44,0
				2	1220	240	0,44	
				1	620	120	0,22	
SCRFD 50-60/280	50	✓		3	1400	470	1,15	44,0
				2	1000	300	0,55	
				1	560	100	0,20	
SCRFD 50-120/280	50	✓		3	2800	950	1,73	44,0
				2	2330	540	1,05	
				1	1270	265	0,46	

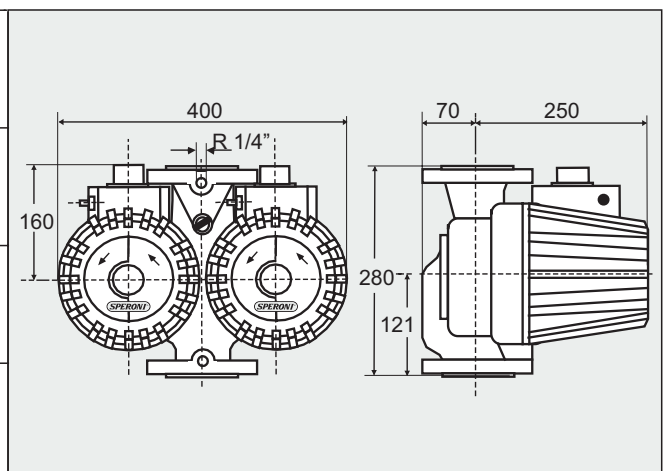

# SCRFD 65

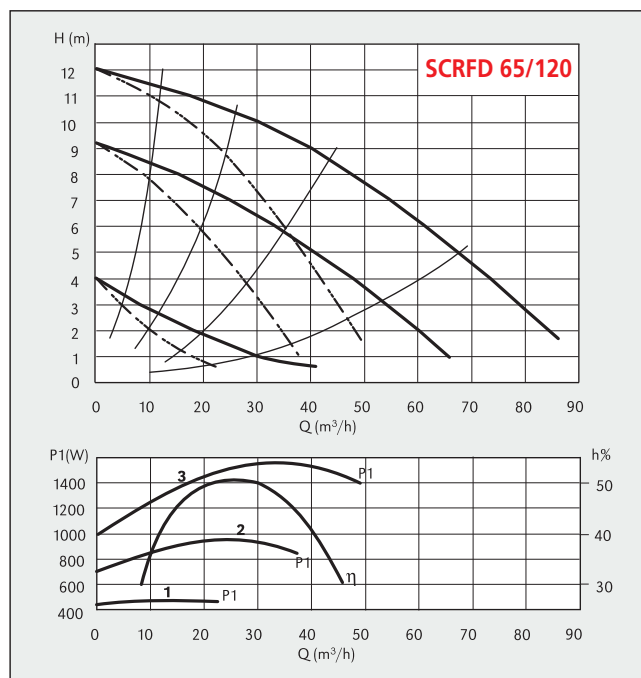
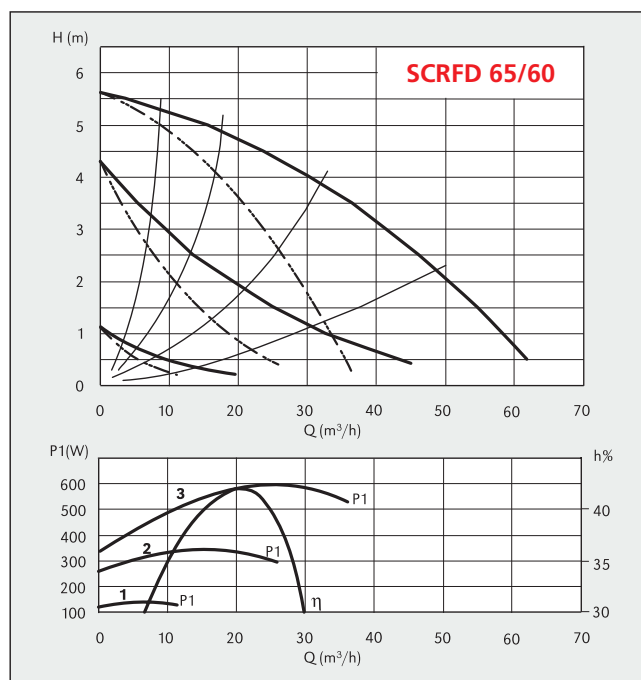
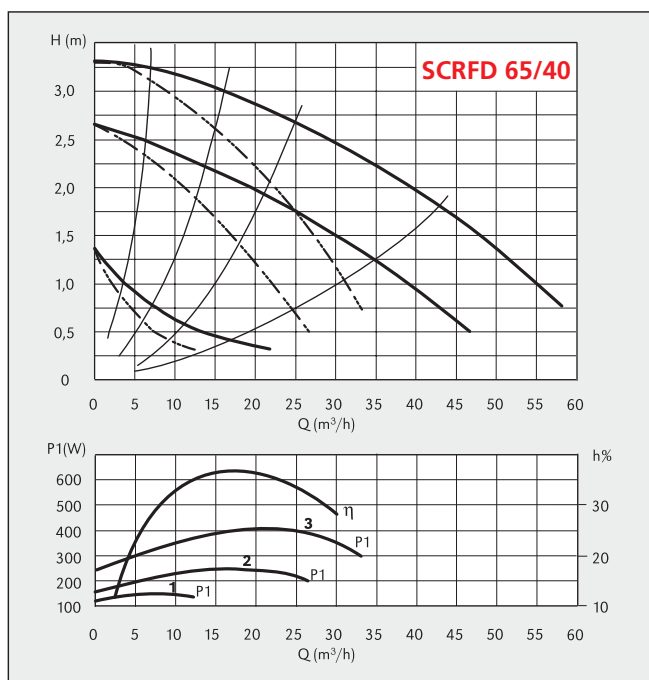

## DIMENSIONS AND WEIGHTS

TYPE	DN	N° Pole		Pos.	1/min	P1 (W)	3x 400 V [A]	[kg]
		2	4					
SCRFD 65-40/340	65	✓		3	1430	400	1,10	49,0
				2	1150	160	0,50	
				1	600	120	0,22	
SCRFD 65-60/340	65	✓		3	1370	600	1,25	49,0
				2	950	360	0,64	
				1	450	120	0,22	
SCRFD 65-120/340	65	✓		3	2810	1560	2,80	54,0
				2	2200	960	1,70	
				1	1250	460	0,84	

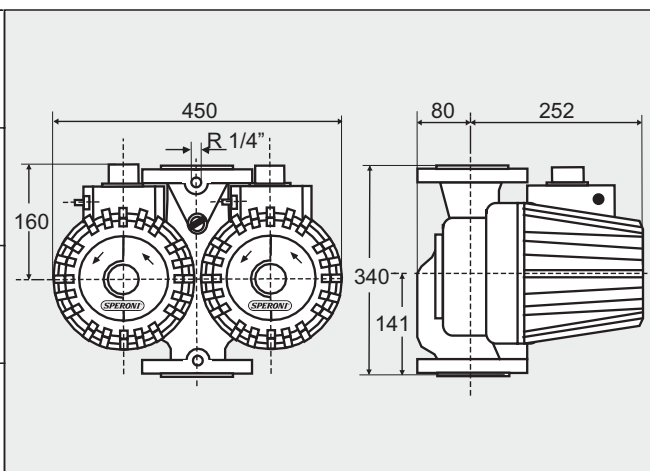

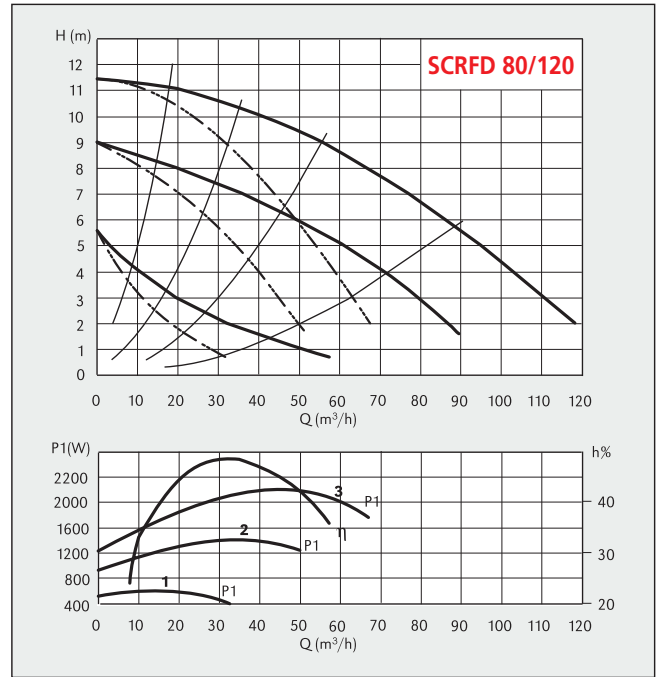
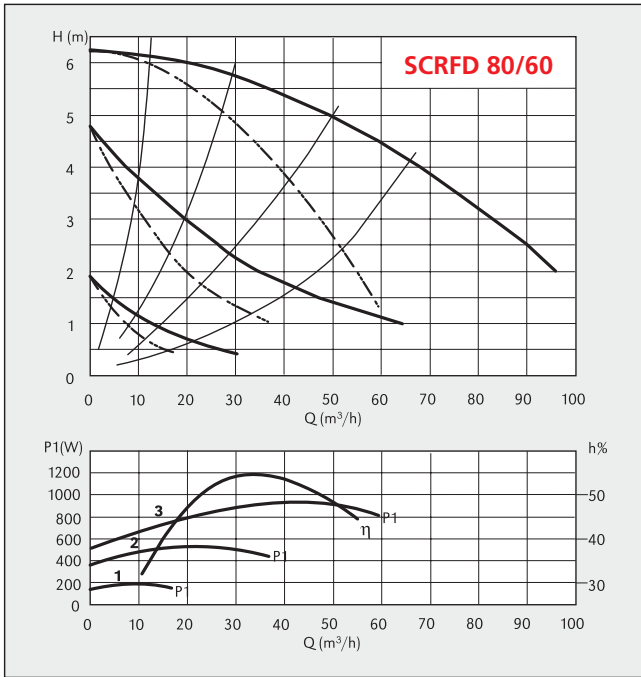

## DIMENSIONS AND WEIGHTS

TYPE	DN	N° Pole		Pos.	1/min	P1 (W)	3x 400 V [A]	[kg]	
		2	4						
SCRFD 80-60/360	80	✓		3	1350	960	2,20	60,0	
				2	1000	560	1,10		
				1	600	200	0,38		
SCRFD 80-120/360	80	✓		3	2800	2200	3,80	62,0	
				2	2160	1400	2,40		
				1	1200	550	1,05		



### Applications

The SPERONI SCRFED circulators for clean liquids, without abrasives, which are non-aggressive for the pump materials (contents of solids up to 0.2%).  
 For heating, conditioning, cooling and circulation plants.  
 For civil and industrial applications.  
 When low noise operation is required.

### Limits of application

- Liquid temperature from -10 °C to +120 °C (in short-time duty up to + 140 °C).
- Ambient temperature up to 40 °C.
- Maximum glycol quantity: 50% (Mixture with more than 20% glycol content require rechecking of the pumping data).
- Maximum permissible working pressure 6/10 bar.

### Motor

- 2/4 pole induction motor, 50Hz.
- Three adjustable speeds.
- SCRFED: single-phase 230V.
- Insulation class F.
- Protection IP 43.

### Components

- Pump casing Cast iron
- Impeller Stainless steel
- Shaft Stainless steel

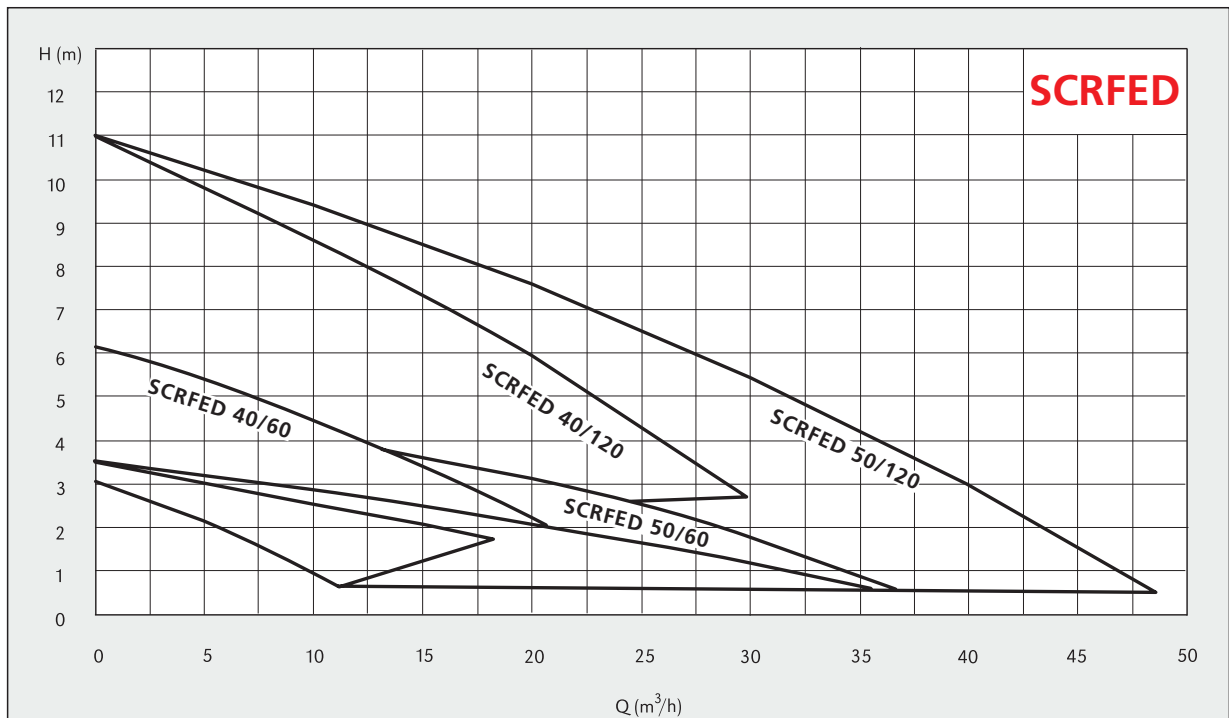

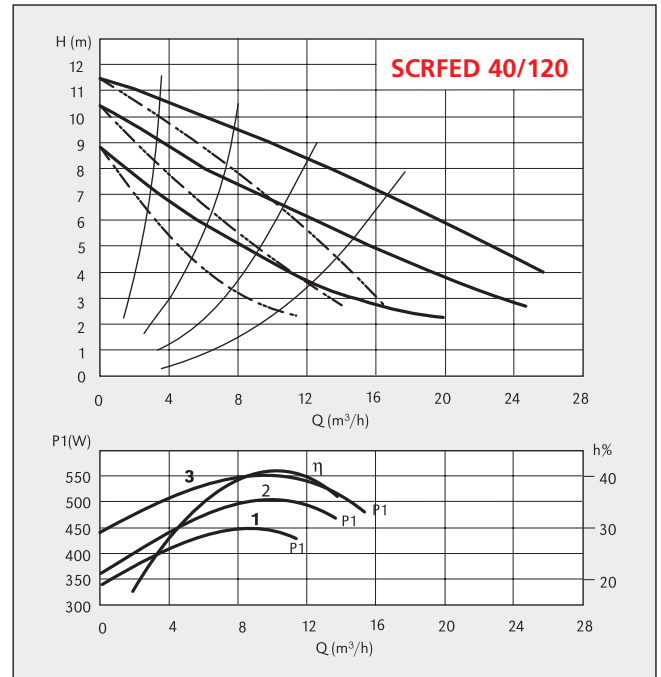
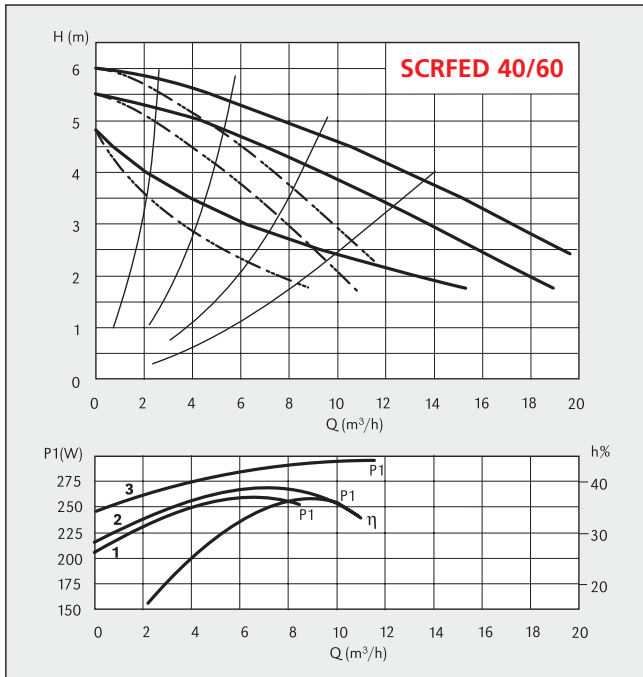

## DIMENSIONS AND WEIGHTS

TYPE	DN	N° Pole		Pos.	1/min	P1 (W)	3x 400 V [A]	[kg]	
		2	4						
SCRFED 40-60/250	40	✓		3	2690	285	1,20	35,0	
				2	2360	245	1,18		
				1	1820	225	1,15		
SCRFED 40-120/250	40	✓		3	2755	550	2,35	35,0	
				2	2100	475	2,30		
				1	1270	355	1,85		

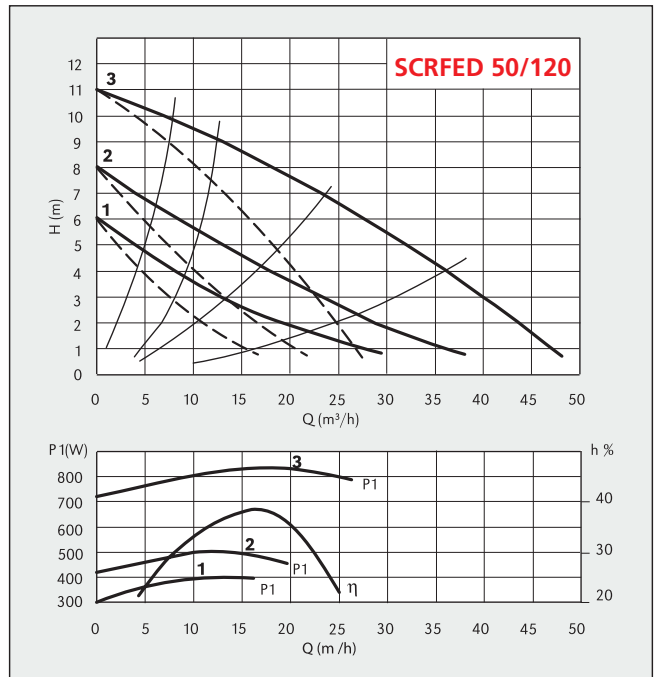
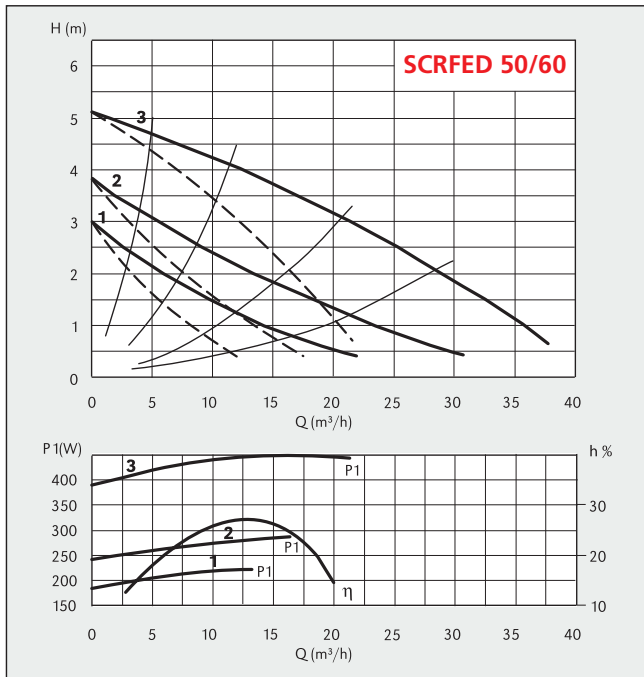

## DIMENSIONS AND WEIGHTS

TYPE	DN	N° Pole		Pos.	1/min	P1 (W)	3x 400 V [A]	[kg]	
		2	4						
SCRFED 50-60/280	50	✓		3	1260	415	1,8	44,0	
				2	1030	300	1,3		
				1	740	230	1,0		
SCRFED 50-120/280	50	✓		3	2720	830	3,6	44,0	
				2	1870	480	2,1		
				1	1450	390	1,7		



**SPERONI®**

42024 Castelnovo di Sotto (Reggio Emilia) - Italy - Via S. Biagio, 59  
tel. +39.0522 487011 - fax (Italy) +39.0522 487019 - fax (World) +39.0522 683070  
[www.speroni.it](http://www.speroni.it) - [speroni@speroni.it](mailto:speroni@speroni.it)

## **ОФИЦИАЛЬНЫЙ ДИЛЕР В УКРАИНЕ:**

[storgom.ua](http://storgom.ua)

## **ГРАФИК РАБОТЫ:**

Пн. – Пт.: с 8:30 по 18:30

Сб.: с 09:00 по 16:00

Вс.: с 10:00 по 16:00

## **КОНТАКТЫ:**

+38 (044) 360-46-77

+38 (066) 77-395-77

+38 (097) 77-236-77

+38 (093) 360-46-77

Детальное описание товара:

<https://storgom.ua/product/tsirkulatsionnyi-nasos-speroni-scr-25-80-1-0.html>

Другие товары: <https://storgom.ua/tsirkulatsionnye-nasosy.html>