

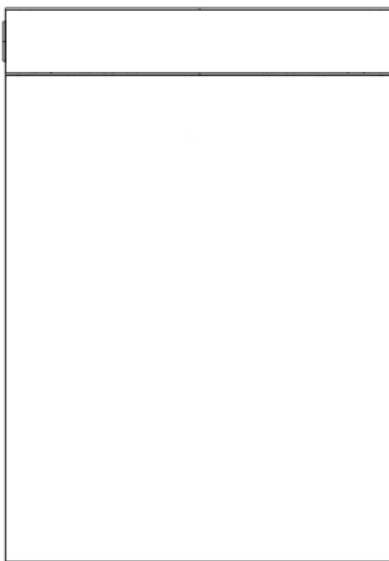

# User Manual

**BLF51 Series (IP21)**





# CONTENTS

- 1. About This Manual ..... 1
  - 1.1 Products Covered by This Manual ..... 1
  - 1.2 Target Group..... 1
  - 1.3 Symbols Used ..... 1
  - 1.4 Storage of the Manual..... 2
- 2. Safety ..... 2
  - 2.1 Important Safety Instructions ..... 2
  - 2.2 Response to Emergency Situations ..... 3
  - 2.3 Limitation of Liability ..... 4
- 3. Scope of Delivery ..... 6
- 4. Product Description ..... 8
- 5. Mounting..... 10
  - 5.1 Environment Requirements ..... 10
  - 5.2 Angle and Space Requirements..... 11
  - 5.3 Mounting the Battery ..... 12
- 6. Electrical Connection ..... 15
  - 6.1 Overview of the Connection Area ..... 15
  - 6.2 Battery Power Connection..... 16
  - 6.3 BMS Communication Connection ..... 17
  - 6.4 Parallel Connection of Multi-batteries ..... 18
- 7. Operating of the Battery..... 20
  - 7.1 LED Indicator ..... 20
  - 7.2 Turn On/Off the Battery ..... 20
- 8. Technical Data..... 21

# 1. About This Manual

## 1.1 Products Covered by This Manual

BLF51 Series Li-ion battery:



BLF51-5

## 1.2 Target Group

This manual is intended for a qualified electrician. Any electrical installation and maintenance on the battery must be performed by qualified electricians in compliance with standards, wiring rules or requirements of local grid authorities or bodies.

## 1.3 Symbols Used

The following types of safety precautions and general information symbols are used in this manual. These important instructions must be followed during installation, operation and maintenance of the battery.

Symbol	Description
 <b>DANGER</b>	Indicates a hazard with a high level of risk that, if not avoided, will result in death or serious injury.
 <b>WARNING</b>	Indicates a hazard with a medium level of risk that, if not avoided, could result in death or serious injury.
 <b>CAUTION</b>	Indicates a hazard with a low level of risk that, if not avoided, could result in minor or moderate injury.
<b>NOTICE</b>	Indicates a situation that, if not avoided, could result in equipment or property damage.

## 1.4 Storage of the Manual

Please keep the manual properly and operate in strict accordance with all safety and operating instructions in this manual. The information in this manual is subject to change without notice. Please check [www.LIVOLTEK.com](http://www.LIVOLTEK.com) for more information.

## 2. Safety

The manual describes the installation, commissioning, maintenance of the battery. Please read it carefully before operating. To prevent personal injury and property damage and to ensure long- term operation of the product, please read and follow all the instructions and cautions on the battery and this user manual during installation, operation or maintenance at all times.

---

### 2.1 Important Safety Instructions

#### **DANGER**

##### **Danger to life from electric shock.**

- Before performing any work on the battery, make sure the battery is power off and the DC isolator is disconnected.
  - Do not short connect the DC connectors of the battery, which may cause electric shock to personnel and damage to the product.
  - Do not touch DC connectors of the battery.
  - If an error occurs, contact your local distributor or qualified electricians.
- 

#### **WARNING**

- Only authorized service personnel are allowed to install the battery or perform servicing and maintenance.
  - The power should be disconnected before attempting any maintenance or cleaning or working to the battery.
-

---

<b>NOTICE</b>
---------------

- Do not open the battery or change any components without authorization, otherwise the warranty commitment for the battery will be invalid.
  - Appropriate methods must be adopted to protect battery from electrostatic discharge; any damage caused by ESD is not warranted by the manufacturer.
- 

## 2.2 Response to Emergency Situations

### ➤ Leaking Batteries

If the battery leaks electrolyte which is corrosive, avoid contact with the leaking liquid or gas. Direct contact may lead to skin irritation or chemical burns. If one is exposed to the leaked substance, do these actions:

- **Accidental inhalation of harmful substances:** Evacuate people from the contaminated area, and seek medical attention immediately.
- **Eye contact:** Rinse eyes with flowing water for 15 minutes, and seek medical attention immediately.
- **Dermal contact:** Wash the affected area thoroughly with soap and water, and seek medical attention immediately.
- **Ingestion:** Induce vomiting, and seek medical attention immediately.

### ➤ Wet Batteries or Damaged Batteries

- If the battery is wet or submerged in water, do not try to access it.
- If the battery seems to be damaged, they are not fit for use and may pose a danger to people or property.

- Please pack the battery in its original container, and then return it to your distributor

➤ **Fire**

- If a fire breaks out where the battery is installed, do these actions:
- Extinguish the fire before the battery catches fire;
- If the battery has caught fire, do not try to extinguish the fire.
- Evacuate people immediately.

## **2.3 Limitation of Liability**

Any product damage or property loss caused by the following conditions LIVOLTEK does not assume any direct or indirect liability.







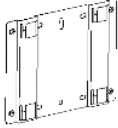

- Product modified, design changed or parts replaced without LIVOLTEK authorization;
- Changes, or attempted repairs and erasing of series number or seals by non LIVOLTEK technician;
- System design and installation are not in compliance with standards and regulations;
- Failure to comply with the local safety regulations;
- The Product has been improperly stored in distributor's or end user's premises;
- Transport damage (including painting scratch caused by movement inside packaging during shipping). A claim should be made directly to shipping or insurance company as soon as the

container/packaging is unloaded and such damage is identified;

- Failure to follow any/all of the user manual, the installation guide and the maintenance regulations;
- Improper use or misuse of the device;
- Insufficient ventilation of the device;
- The maintenance procedures relating to the product have not been followed to an acceptable standard;
- Force majeure (violent or stormy weather, lightning, overvoltage, fire etc.)
- Damages caused by any external factors.



### 3. Scope of Delivery

			
A	B	C	D
			
E(optional)	F	G	H(optional)
			
I			

Item	QTY	Designation
A	1	Battery
B	1	Wall Mounting Bracket
C	4	Screws for Fixing Mounting Bracket
D	1	Manual
E	1 pair	Power cable-to livoltek inverter positive&negative,4AWG;
F	1 pair	Parallel Power cable- positive & negative, 4AWG;
G	1	Communication cable; Double RJ45 plug;

H	1	RJ45 terminal resistor(Optional)
I	1	MSDS report documents

**NOTICE**

Accessories for different applications may be different.

## 4. Product Description

Thank you for choosing the LIVOLTEK battery. The **BLF51 Series** battery is a series of Low Voltage Lithium-ion battery. It is designed for residential and commercial energy storage system. It must only be connected with a officially tested inverter (Hybrid or Off-Grid series).

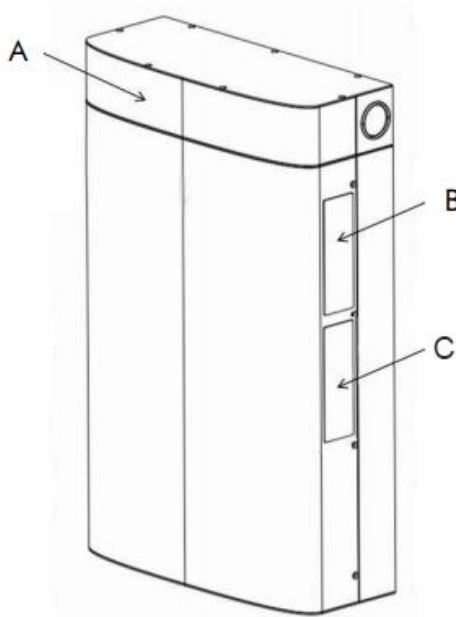





Figure 1. View of the BLF51 Series Lithium Battery

Position	Designation
A	Connection Area Cover For All-in-one application with hybrid inverter, the cover is not included.
B	Nameplate Label: Clearly identify the product, including the SN, technical data, certifications, etc.
C	Warning label (Optional)

 **CAUTION**

If the battery is not used or not installed for a long time, it is recommended to measure the voltage and charge it before use for better maintenance.

**Icons on the Nameplate**

Symbol	Explanation
	Caution, Risk of Danger
	Caution, Risk of Electric Shock
	Refer to the Operating Manual
	WEEE Mark. This battery should not be disposed as ordinary waste.

# 5. Mounting

## 5.1 Environment Requirements

<b>NOTICE</b>
---------------

Install the Battery System on the surface with sufficient bearing capacity and flatness, **wooden surface is prohibited** . Increase the bearing capacity and flatness of the surface by laying the foundation, adding bearing plates and so on.

- **Keep children away from the equipment.**
- The optimal ambient temperature for the battery is 15~35°C.
- Avoid exposing the equipment to direct sunlight or rain.
- Install the equipment away from heat/cold source.
- Do not install the equipment in the place where the temperature changes extremely.
- Install the equipment away from strong interferences to ensure its regular work.
- Do not install the equipment in places prone to accumulate water.
- Do not put inflammable or explosive matters near the equipment.

## 5.2 Angle and Space Requirements

**⚠ CAUTION**

Never install the Battery horizontally, or with a forward tilt or with a backward tilt or even with upside down. Install the battery upright or at a maximum back tilt of 15 degrees to facilitate heat dissipation.

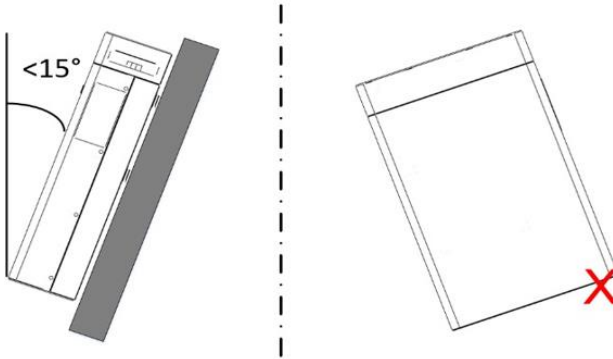

This battery is indoor version and can be only installed in an indoor location. The space around batteries recommended refer to the figure below

**⚠ CAUTION**

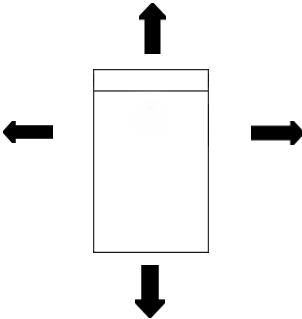

Space Requirement

Position	Min.size
Left	100
Right	100
Top	200 (inverter not included)
Bottom	50
Front	300

## **5.3 Mounting the Battery**

### **5.3.1 Unpack and Check for Transport Damage**

Unpacking the battery package and make sure the battery is intact during transportation. If there are some visible damages, such as cracks, or missing, please contact your dealer immediately.

### **5.3.2 Procedure for All-in-one Application**

The battery bracket, power cables, and BMS cables are along with the inverter in the inverter package. For more detailed information and installation steps, please refer to the inverter user manual.

### **5.3.3 Procedure for Expansion Application**

---

#### **STEP 1: Anchor Battery Bracket**

- Plan and measure the distance between system components and determine whether cables will be routed into the system from the top, bottom, or side of the enclosure before installation.
- Make sure the wall is strong enough to withstand the weight of battery.
- Take out the Wall-mounting Bracket (battery-bracket) and locate the appropriate drilling holes, then mark it with a marker pen.
- Drill holes with driller, make sure the holes are deep enough (at least 60mm) to support the battery.

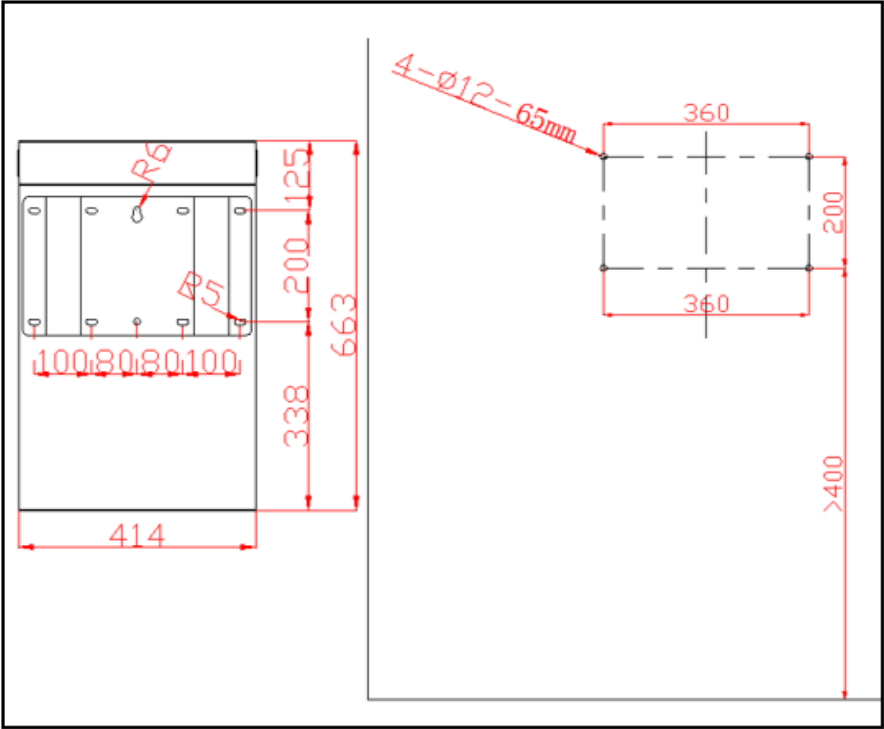

Product back dimension drawing

### STEP 2: Screw the bracket on the wall

- Use expansion bolts or correct wall fixings to attach the mounting bracket on the wall tightly.

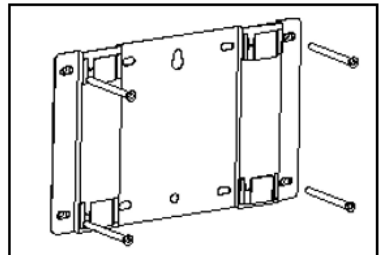



---

### STEP 3: Mount the Battery to the Bracket

- Lift and hang the battery to the battery-bracket and ensure that the two mounting ears perfectly engage with the battery -bracket.

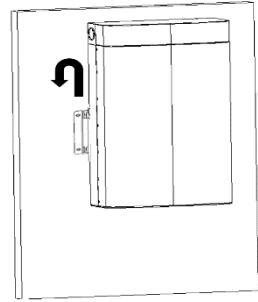

---

### STEP 4: Open the Connection Area Cover

- Pull out the front cover of the wiring area, unscrew the upper cover and open the upper cover, then connect the battery cable and the BMS communication cable (refer to in Chapter 6).

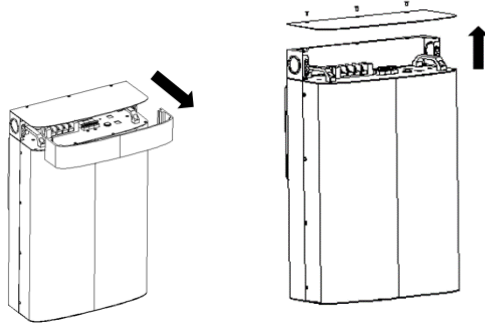

---

### STEP 5: Install the Connection Area Cover

- After the electrical connections is finished, put on the upper cover of connection area and lock the screws and then push in the front cover.

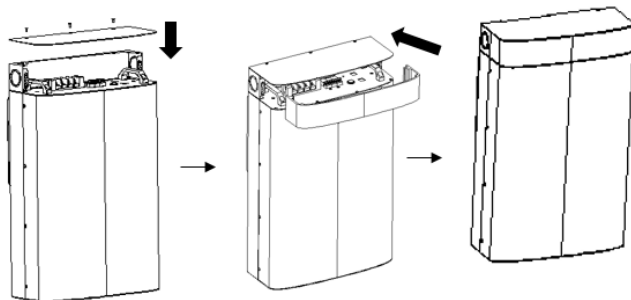

## 6 Electrical Connection

### 6.1 Overview of the Connection Area

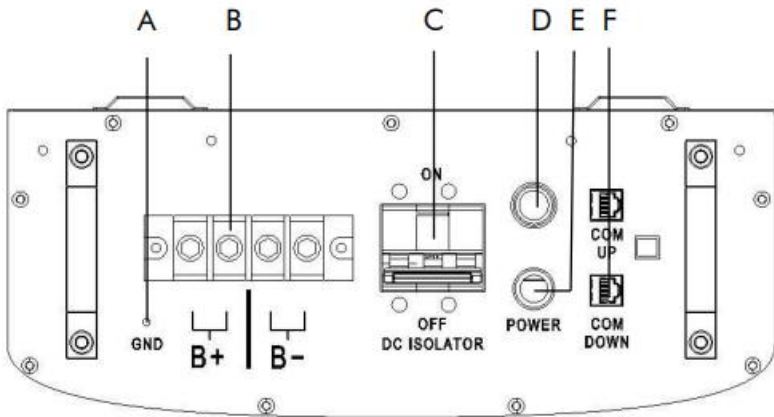

Position	Designation
A	Grounding Port
B	Battery Power Ports
C	DC Isolator
D	LED Indicator
E	Power Switch
F	BMS Ports

## 6.2 Battery Power Connection

### Battery connection diagram

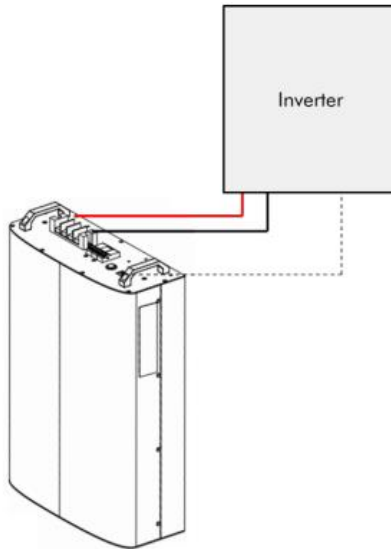

### Procedure:

#### CAUTION

Before connecting the power cables, make sure the DC isolator of the battery is disconnected.

#### STEP 1:

- Please assemble the connectors if they are not pre-assembled.
- Install the connectors to battery power ports; make sure the polarities are correct

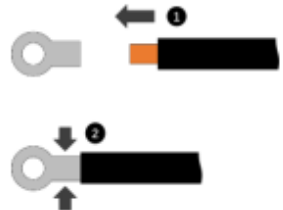

#### STEP 2:

- Plug the other ends of power cables into inverter. Please contact with your inverter vendor for detailed information.

## 6.3 BMS Communication Connection

Please check whether the BMS communication cable in the accessory box is appropriate for the battery. If you are not sure for that, please confirm with your vendor.

### Procedure:

---

#### STEP 1:

- Please insert the RJ45 connector into the BMS port of battery.
- 

#### STEP 2:

- Please insert the other end of the cable in the corresponding port of inverter.
- 

### BMS Connector Pin Definition:

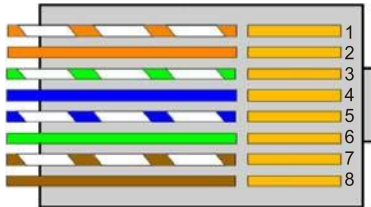

1. BMS\_CAN\_H
2. BMS\_CAN\_L
3. BMS\_485\_A
4. GND
5. BMS\_485\_B
6. NULL
7. NULL
8. NULL

## 6.4 Parallel Connection of Multi-batteries

Expandability: Up to 5 units of **BLF51 Series** batteries can be parallel connected in one system.

### Parallel Connection Diagram (Expansion Application)

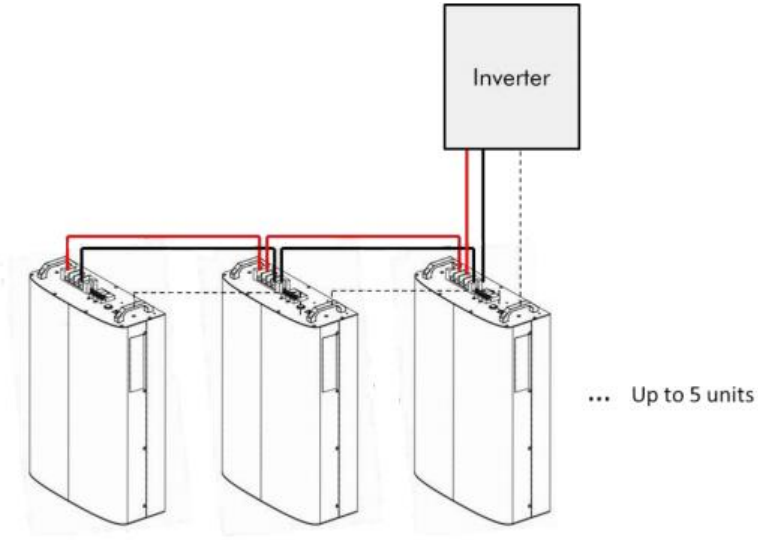

### Procedure:

---

#### STEP 1:

- Connect all the positive terminals of power ports of each battery.
- Connect all the negative terminals of power ports of each battery.
- Connect the power ports to inverter.

#### STEP 2:

- Connect the BMS ports of each battery. The COM DOWN should
-

---

be connected to the COM UP.

- Then connect the BMS port to inverter.

---

**STEP 3:**

- Plug the RJ45 terminal resistor into the COM DOWN port of the farthest battery from the inverter.
-

## 7 Operating of the Battery

### 7.1 LED Indicator

The LED indicates the operating state of the battery.

LED	Explanation
Green	Green light indicates the battery works well.
Red	Warning light (when red light is on for more than 12 hours) indicates fault occurs in the battery, please contact technical support for help.

### 7.2 Turn On/Off the Battery

- When turn on the battery, turn on the isolator firstly, then switch on the battery;
- When turn off the battery, switch off the battery firstly, then disconnect the isolator.

## 8 Technical Data

Electrical Data	BLF51-5
Cell Type	LFP
Total Energy	5kWh
Depth of Discharge	90%
Usable Energy	4.5 kWh
Nominal Voltage	51.2 V
Nominal Capacity	100 Ah
Operating Voltage Range	40-58.4 V
Rated Charge/Discharge Current	50 A/50A
Max. Charge/Discharge Current@25°C	50A/100A
Max. Parallel Number	5 Units
General Data	
Mounting information	Wall-mounted
Communication	CAN / RS485
Operating Temperature	0~45°C charge / -10~55°C discharge
Dimension(W*H*D)	415*662*178 mm
Weight	55 kg
IP Protection Type	IP21



Contacts:

**Hangzhou LIVOLTEK Power Co., Ltd**

**Address:** 1418-35 Moganshan Road, Hangzhou, 310011, China

**Tel:** +86-571-28330320

**Fax:** +86-571-28020357

**Email:** [info@livoltek.com](mailto:info@livoltek.com)

**Web:** [www.livoltek.com](http://www.livoltek.com)

## **ОФИЦИАЛЬНЫЙ ДИЛЕР В УКРАИНЕ:**

[storgom.ua](http://storgom.ua)

### **ГРАФИК РАБОТЫ:**

Пн. – Пт.: с 8:30 по 18:30

Сб.: с 09:00 по 16:00

Вс.: с 10:00 по 16:00

### **КОНТАКТЫ:**

+38 (044) 360-46-77

+38 (066) 77-395-77

+38 (097) 77-236-77

+38 (093) 360-46-77

Детальное описание товара:

<https://storgom.ua/product/livoltex-216084.html>

Другие товары:

<https://storgom.ua/dopolnitelnye-batarei-dlya-zaryadnyh-stancij.html>