

TECHNICAL HIGHLIGHT

EP600 Energy Storage System



Apart from **6000W output, 6000W input** and 79kWh maximum capacity, EP600 is a modular ESS (Energy Storage System) that also features an intelligent Battery Management System (BMS), a reliable Lithium Iron Phosphate (LFP) battery pack, along with an intuitive APP and fast charging capability through the mains and solar energy, always giving you an optimal performance regardless of the cold or hot weather



The EP600 energy storage system include grid-connected inverter, energy storage battery pack, IOT controller and other accessories (CT, cables, etc.), which can form a household energy storage and PV grid-connected power generation system with PV and user distribution box. This system is suitable for families and regions with energy shortage or unstable power supply. The system has intelligent power generation and UPS function, and it can be operated and monitored by APP. It is simple operation, economical and practical. Whether you want to get rid of high electricity bills, get tired of fluctuating power supply from time to time or prepare for a clean energy solution, the BLUETTI EP600 ESS is ready to help.

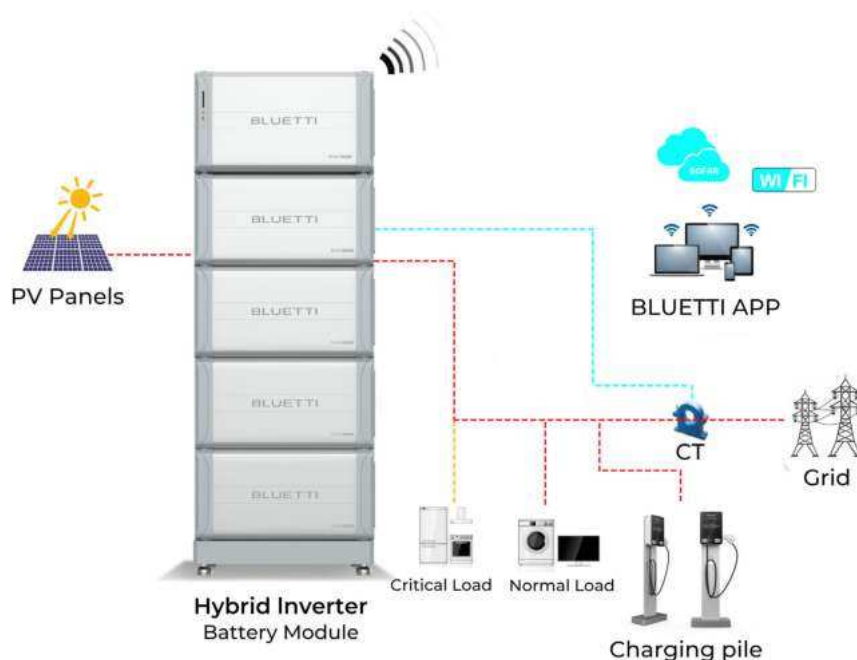

TECHNICAL HIGHLIGHT

Real All-round energy supply integrating photovoltaic, energy storage and on/off-grid functionally.

The EP600 energy storage system are composed of efficient MPPT control unit, advanced bidirectional parallel off-grid inverter unit, highly reliable energy storage battery cell and highly intelligent communication controller. Users only need to configure the appropriate PV modules to achieve the independent supply and power generation management of the entire home energy, which is a real household energy solution integrating PV, energy storage and on/off-grid connection.

High protection, low noise, smarter, as safe and easy to use as home appliances.

The inverter and battery pack adopt high-strength, all-aluminum alloy metal shell, with the protection level up to IP65 and the noise not higher than 50dB; Based on the high frequency isolation design and equipped with a optimized smart APP, the inverter brings users the experience of home appliances and equipment on safety protection, environmental adaptability, easy use and maintenance.

Scalable modular design, easy to install, safe and convenient.

Adopting modular design, EP600 ESS users can purchase different units of battery pack according to own needs, to improve the economy of the system. The system is stacked on the ground for installation. On one hand, the installation is simple and the damage to the wall is small, On the other hand, it weakens the requirements for wall materials and load-bearing, making the installation more safe and reliable.

Advanced Thermal management technology, without fear of cold.

The battery pack is equipped with a heating system that automatically starts the heating function when the ambient temperature is low, so that the product can adapt to the use of low temperature environments, overcome the congenital weaknesses of lithium batteries, and improve the service life of the battery. In the meantime, the inverter can intelligently regulate the speed of the fan according to the internal temperature, ensuring a full load output at 40°C.

Internationally leading household smart energy management, excellent Return On Investment.

Based on the excellent system energy management strategy, balanced decision-making is made in various working modes such as photovoltaic power generation revenue, energy self-sufficiency, emergency energy backup, etc., while taking into account system cost and reliability, including the cost of photovoltaic modules, battery life, system utilization and other aspects, so as to achieve excellent user return on investment.

EP600 INVERTER SPECIFICATION

EP600 inverter is a three-phase PV energy storage inverter integrated PV input and grid-connection charging and discharging. It is an important part of EP600 energy storage system.

PV application: Dual MPPT, which can achieve PV charge and storage energy, and also can generate power with grid-connected system.

Energy storage application: Intelligent user application mode, which can automatically control the flow of system charging and discharging power or according the user demand to adjust the energy actively.

UPS application: Under the uninterruptible power supply (UPS) mode, the switching time of on-grid and off-grid is less than 10ms, and off-grid output can connect the unbalanced load.

Battery expansion: Support parallel with 2-16 battery packs (B500) to expand the total capacity.

Intelligent monitor: WiFi/Bluetooth, support using app to control, monitor, and check the system condition at anytime and anywhere.

High protection: The protection level of the system is IP65, which can be installed and used in great majority environments.

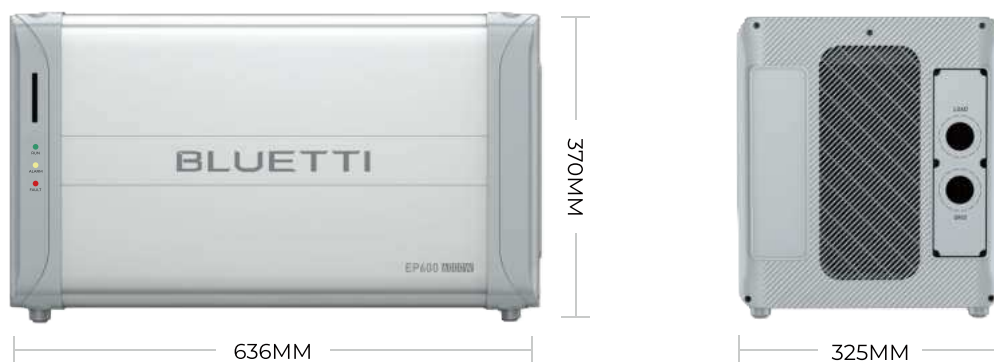

AC (GRID-TIED)	
Rated Output Power	6000W
Output Apparent Power	6000VA
Wiring	L1/L2/L3/N/PE
Rated Voltage	230V/400V
Voltage Range	185V-285VAC×3
Rated Output Current	8.7A×3
Maximum Output Current	9.1A×3

Input Frequency	50Hz
Frequency Range	47.5-51.5Hz
Maximum Output Apparent Power	12000VA, Bypass + Charge
Maximum Input Current	18A, Bypass + Charge
Power Factor (PF)	0.9 Leading-0.9 Lagging Adjustable
Current Total Harmonic Distortion (THD)	<3%, At Rated Power
On and Off-Grid Switching Time	<10ms
Round-trip Efficiency	>82%(AC/AC), Grid-Battery-AC Load
Protection	Anti-islanding Protection, Residual Current Monitor, Output Overcurrent Protection

AC (OFF-GRID)

Rated Output Power	6000VA
Output Voltage	230V/400V
Output Current	8.7A×3
Output Frequency	50Hz
Inversion Efficiency	94.0% Max.
Output Voltage THD	<3%, Purely Resistive Load
Protection	Output Overcurrent Protection Output Short-circuit Protection Over Temperature Protection

PV INPUT

Maximum Input Power	6000W
MPPT Channel	2
Array In Series	1
Maximum Input Voltage	550V
MPPT Voltage Range/Rated	150V-500V/360V
Single MPPT Maximum Input Current	12.5A
Single MPPT Maximum Short-circuit Current	15A
MPPT Efficiency	99.9%
PV Inverter Efficiency	93.6% Peak
Protection	Reverse Polarity Protection Insulation Resistance Detection

GENERAL

Relative Humidity	5%-95%
Static Power	23W
Standby Power	64W
Operating Temperature	-20°C-50°C
Noise	≤50dB (A)
Cooling	Forced Air Cooling
Protection Grade	IP65
Operating Altitude	≤2000m
Dimensions (L*W*H)	636mm×325mm×370mm
Net Weight	40Kg

STANDARD & AUTHENTICATION

Safety	IEC62109-1, IEC62109-2, EN62109-1, EN62109-2
Grid Connections	VDE-AR-N4105, VDEV 0124-100
Emissions(EMC/EMI)	EN IEC 61000-6-1, EN/IEC 61000-6-3
RoHS	RoHS 2.0
IP65	IEC60529
Certifications	CE

LIMITED WARRANTY

Limited Warranty	10 years
------------------	----------

B500 Battery Pack Specification

The B500 energy storage battery system is designed for residential and small commercial uses. Single pack rated capacity is 4.96KWh. It support 16 battery packs in parallel to meet capacity up to 80KWH.

The B500 battery management system adopts a multi-level architecture, which can detect the voltage, current and temperature of the battery pack in real time during the charging and discharging process. Accurately and efficiently realize the over-voltage, under-voltage, over-current, over-temperature and under-temperature protection of the system.

The safety function of B500 control system adopts redundant design, which meets the functional safety requirements and has good safety and stability.

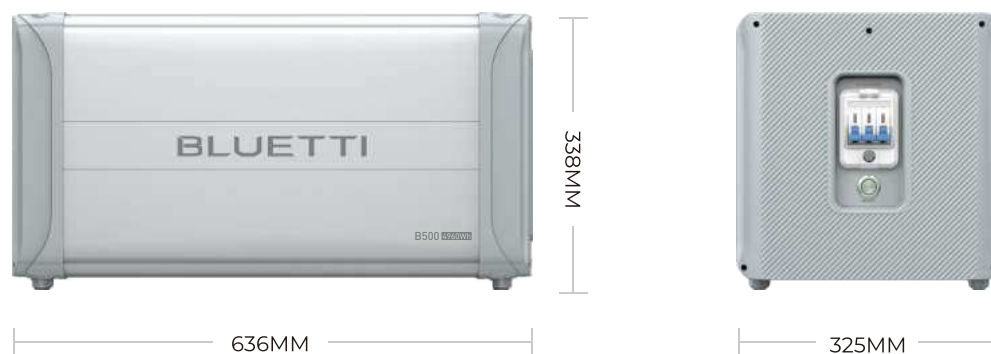

B500

Battery Type	LiFePO4	LiFePO4 Cells
Battery Voltage	99.2V	3.2V×31
Rated Capacity	4960Wh	25℃, Charge: 0.5C/3.6V/0.05C Discharge: 0.5C/2.5V
Usable Capacity	4464Wh	90% DoD, 25℃, 0.5C charge and 0.5C discharge.
Cell Overvoltage Protection	3.7V	
Cell Undervoltage Protection	2.5V	
Maximum Input Voltage	108.5V	3.5V×31
Minimum Output Voltage	86.8V	2.8V×31

Maximum Input Current	25A	The continuous input current is affected by temperature and SoC.
Maximum Output Current	50A	The continuous input current is affected by temperature and SoC.
Short-circuit Protection	Yes	
Discharge Over Temperature Protection	61°C	
Discharge Over Temperature Recovery	53°C	
Discharge Under Temperature Protection	-22°C	

Discharge Over Temperature Protection	61°C	
Discharge Over Temperature Recovery	53°C	
Discharge Under Temperature Protection	-22°C	
Discharge Under Temperature Recovery	-18°C	
Charge Over Temperature Recovery	47°C	
Charge Under Temperature Protection	-1°C	
Charge Under Temperature Recovery	1°C	
Noise	<25dB	No Fan
Number of Battery in Parallel	Up to 16 Batteries Supported	A combiner box* is required for 5 or more B500S
Storage Temperature	-20°C -40°C/Store for 1 month 0°C-35°C/ Store for 6 months	Inverter connects to the grid
Working Humidity	5%-95%	Relative Humidity
Operating Altitude	<2000m	
Cooling	Forced Air Cooling	
Protection Grade	IP65	
Installation	Up to 4 Batteries Stacked on the Ground	
Net Weight	58Kg	
Connectivity	WiFi/USB/Bluetooth	
Standard & Authentication	IEC62619, UL1973, UL9540A, UN38.3, EN/IEC61000-6-1, EN/IEC	

LIMITED WARRANTY

Limited Warranty	10 years
------------------	----------

TECHNICAL HIGHLIGHT

DC COUPLING

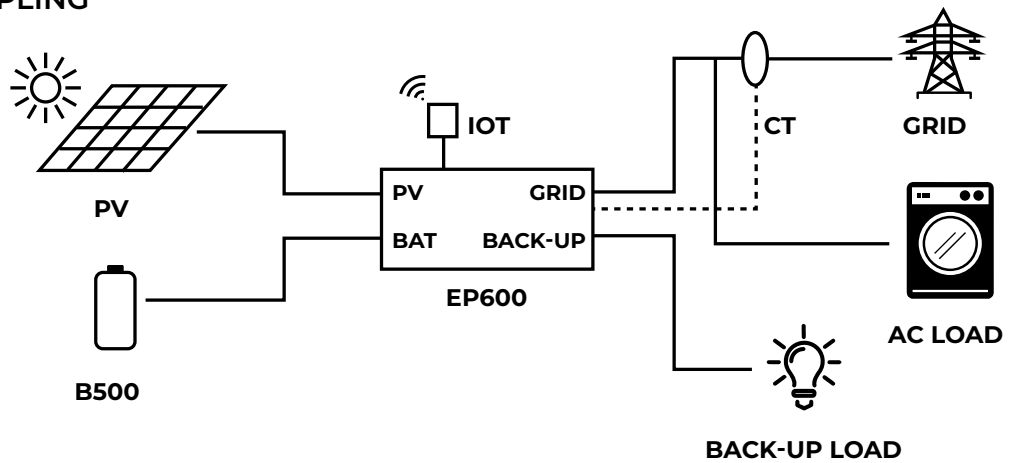

AC COUPLING

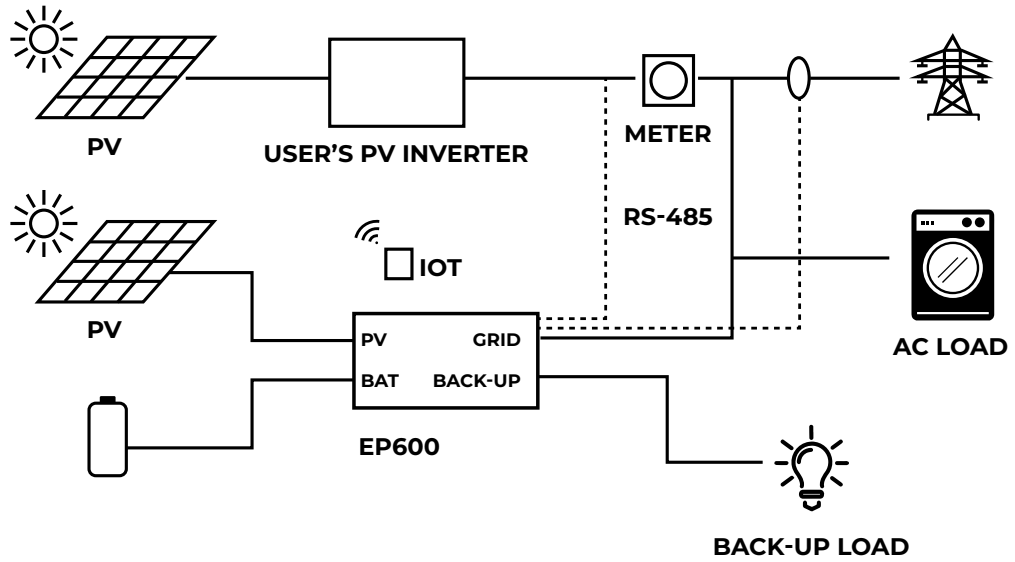

AC-DC COUPLING

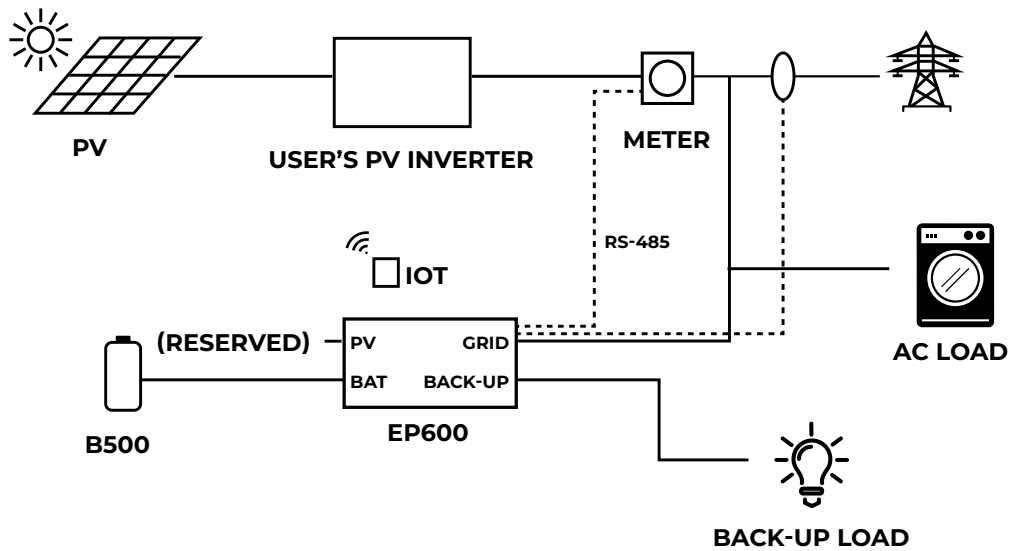



BLUETTI

From the very beginning, BLUETTI has tried to stay true to a sustainable future through green energy storage solutions for both indoor and outdoor use while delivering an exceptional eco-friendly experience for everyone and the world. BLUETTI is making its presence in 70+ countries and is trusted by millions of customers across the globe.

 **HQ: Shenzhen Poweroak Newener Co., Ltd.**

 ADDRESS: Guangdong Shenzhen Nanshan Floor 19, Building 1, Kaidar Group Center Building
168 Tongsha Road, Xinwei Community, Xili Street

 TEL: +86 755-23705916

 **German Branch: POWEROAK GmbH**

 ADDRESS: Lindwurmstr. 114 80337 München

 TEL: 0421-87852946

ОФИЦИАЛЬНЫЙ ДИЛЕР В УКРАИНЕ:

storgom.ua

ГРАФИК РАБОТЫ:

Пн. – Пт.: с 8:30 по 18:30

Сб.: с 09:00 по 16:00

Вс.: с 10:00 по 16:00

КОНТАКТЫ:

+38 (044) 360-46-77

+38 (066) 77-395-77

+38 (097) 77-236-77

+38 (093) 360-46-77

Детальное описание товара: <https://storgom.ua/product/bluetti-172652.html>

Другие товары: <https://storgom.ua/sistemy-energonezavisimosti.html>