



Stufenleiter • Standing Step Ladder • Drabiny ze stopniami wolnostojące
 Lépcsőfokos állólétra • Стремянка со ступенями • Escalera doble de escalones



| | | | | | |
|--------------------------|-----------|--------|--------|--------|--|
| Art.-No. 000712 / 021037 | 3 (ca. m) | 3,0 kg | 2,55 m | 0,55 m | |
| Art.-No. 000705 / 021068 | 4 (ca. m) | 3,6 kg | 2,80 m | 0,80 m | |
| Art.-No. 000729 / 021075 | 5 (ca. m) | 4,2 kg | 3,00 m | 1,00 m | |
| Art.-No. 000736 / 021099 | 6 (ca. m) | 5,0 kg | 3,20 m | 1,20 m | |
| Art.-No. 000743 / 021013 | 7 (ca. m) | 6,2 kg | 3,45 m | 1,45 m | |

Vielzweckleiter • Multipurpose Ladder • Drabina wielofunkcyjna
 Sokelú létra • Универсальная лестница • Escalera multipropósito



| | | | | | | | | | | |
|--------------------------|--------|-------------|--------|--------|--------|--------|--------|--------|--------|--------|
| Art.-No. 010377 / 010376 | 3 x 7 | ca. 9,8 kg | 2,95 m | 1,95 m | 3,20 m | 1,90 m | 3,75 m | 2,95 m | 5,10 m | 4,20 m |
| Art.-No. 010384 / 011380 | 3 x 8 | ca. 11,8 kg | 3,20 m | 2,25 m | 3,50 m | 2,15 m | 4,00 m | 3,20 m | 5,40 m | 4,50 m |
| Art.-No. 010391 / 010390 | 3 x 9 | ca. 13,0 kg | 3,50 m | 2,50 m | 3,75 m | 2,45 m | 4,55 m | 3,75 m | 6,20 m | 5,30 m |
| Art.-No. 010407 / 010406 | 3 x 10 | ca. 15,6 kg | 3,75 m | 2,80 m | 4,05 m | 2,70 m | 5,10 m | 4,30 m | 7,00 m | 6,15 m |
| Art.-No. 010421 / 010420 | 3 x 11 | ca. 17,8 kg | 4,05 m | 3,10 m | 4,30 m | 2,95 m | 5,35 m | 4,55 m | 7,25 m | 6,45 m |





Vielzweckleiter • Multipurpose Ladder • Drabina wielofunkcyjna
 Sokcélú létra • Универсальная лестница • Escalera multipropósito



Zusätzlich mit Treppenfunktion
 Additionally with stair function
 Można korzystać z drabiny na schodach, podestach ...
 Lépcsőfunkcióval kikészítve
 дополнительно с лестничной функцией
 Además con función para escaleras



| | |
|---|--|
| Art.-No. 013361 / 013360 3 x 6 ca. 8,8 kg (ca. m) | |
| Art.-No. 013378 / 013377 3 x 7 ca. 10,5 kg (ca. m) | |
| Art.-No. 013385 / 013384 3 x 8 ca. 12,0 kg (ca. m) | |
| Art.-No. 013392 / 013391 3 x 9 ca. 13,5 kg (ca. m) | |
| Art.-No. 013408 / 013407 3 x 10 ca. 16,0 kg (ca. m) | |
| Art.-No. 013422 / 013421 3 x 11 ca. 18 kg (ca. m) | |



Anlegeleiter • Leaning Ladder • Drabiny przystawne
Támasztólétra • Приставная лестница • Escalera de pared

Schiebeleiter • Extension Ladder • Drabiny rozsuwane
Tolólétra • Выдвижная лестница • Escalera corredera



| | | | |
|---------------------------------|---------|------------|--------|
| Art.-No. 010087 / 010086 | 8 | ca. 3,3 kg | 3,20 m |
| | (ca. m) | | 2,25 m |
| Art.-No. 010100 / 010116 | 10 | ca. 4,1 kg | 3,75 m |
| | (ca. m) | | 2,80 m |
| Art.-No. 010117 / 010109 | 11 | ca. 4,5 kg | 4,05 m |
| | (ca. m) | | 3,10 m |



| | | | |
|---------------------------------|---------|-------------|--------|
| Art.-No. 012081 / 012080 | 2 x 8 | ca. 7,8 kg | 4,85 m |
| | (ca. m) | | 3,90 m |
| | | | 3,20 m |
| | | | 2,25 m |
| Art.-No. 012111 / 012110 | 2 x 11 | ca. 10,5 kg | 6,20 m |
| | (ca. m) | | 5,30 m |
| | | | 4,00 m |
| | | | 3,10 m |

Seilzugleiter • Rope-Operated Extension Ladder • Dwuczęściowe drabiny rozsuwane linką • Kétrészes húzóköteles létra • Лестница двухсекционная • Escalera extensible por cable, dos partes

Mehrzweckleiter • Multipurpose Ladder • Drabiny rozstawno-przystawne • Többcélú létra • Универсальная лестница Escaleras multipropósito



| | | | |
|---------------------------------|---------|-------------|--------|
| Art.-No. 010513 / 011519 | 2 x 14 | ca. 14,8 kg | 7,55 m |
| | (ca. m) | | 6,70 m |
| | | | 4,85 m |
| | | | 3,90 m |
| Art.-No. 011527 / 011526 | 2 x 16 | ca. 19,4 kg | 8,65 m |
| | (ca. m) | | 7,85 m |
| | | | 5,40 m |
| | | | 4,50 m |



| | | | |
|---------------------------------|---------|-------------|--------|
| Art.-No. 010285 / 010284 | 2 x 8 | ca. 8,4 kg | 4,75 m |
| | (ca. m) | | 3,90 m |
| | | | 3,40 m |
| | | | 3,20 m |
| | | | 2,25 m |
| | | | 2,15 m |
| Art.-No. 010223 / 010222 | 2 x 11 | ca. 11,2 kg | 6,05 m |
| | (ca. m) | | 5,30 m |
| | | | 4,20 m |
| | | | 3,95 m |
| | | | 3,10 m |
| | | | 2,95 m |



StandBoard • Work platform • Podest roboczy
Dobogó • Рабочая платформа • Plataforma de trabajo

Gelenk-Universalleiter • Hinged Multipurpose Ladder • Uniwersalna
drabina przegubowa • Univerzális csuklós létra • Шарнирная
универсальная лестница • Escalera universal articulada

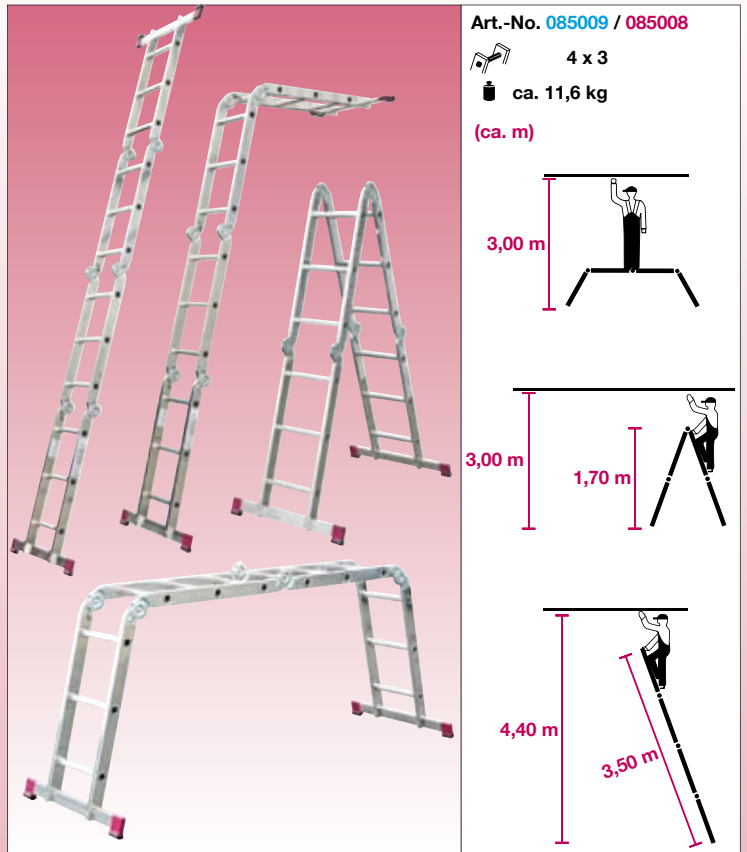
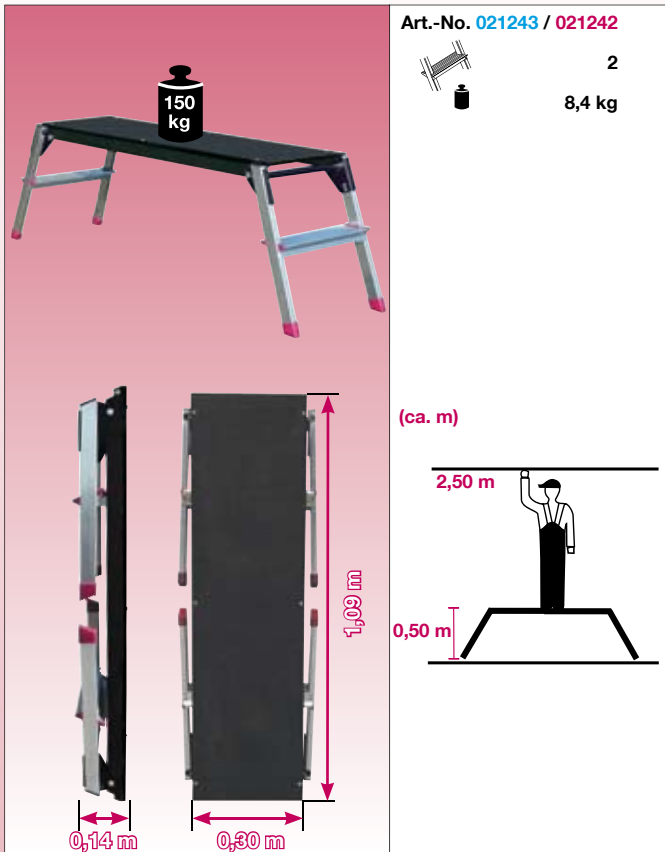

Leitergerüst • Scaffold Ladder • Rusztowanie drabinowe
Létra és állvány egyben • Лестничные подмости • Andamio de escaleras

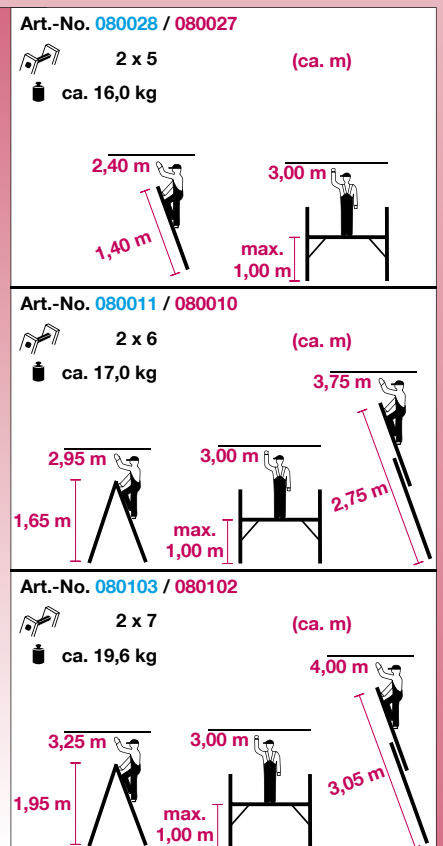



Kleingerüst • Small Scaffold • Mini rusztowanie
Kisállvány • малые передвижные подмости • Pequeño Andamio

Art.-No. **916174 / 950078**
ca. 18,0 kg
BGR 173 / 150 kg

(ca. m)
3,00 m
1,00 m
1,95 m

Klappgerüst • Foldable Scaffold • Rusztowanie składane
Összecsukható állvány • складывающиеся подмости • Andamio con base plegable

Art.-No. **916198 / 950092**
ca. 15,0 kg
BGR 173 / 150 kg

(ca. m)
2,90 m
0,90 m
1,77 m



Montagegerüst • Assembly Scaffold • Rusztowanie montażowe
Szerelőállvány • Монтажные подмости • Andamio de montaje



Art.-No. 916129 / 950023

ca. 48,0 kg

EN 1004 / 150 kg/m²

(ca. m)

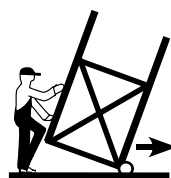
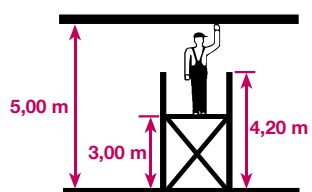



Gelenk-Gerüst • Hinged Scaffold • Rusztowanie montażowe
 Csuklós szerelőállvány • шарнирные подмости • Andamio con articulación

max. ca. 4,85 m

**NEU
NEU**

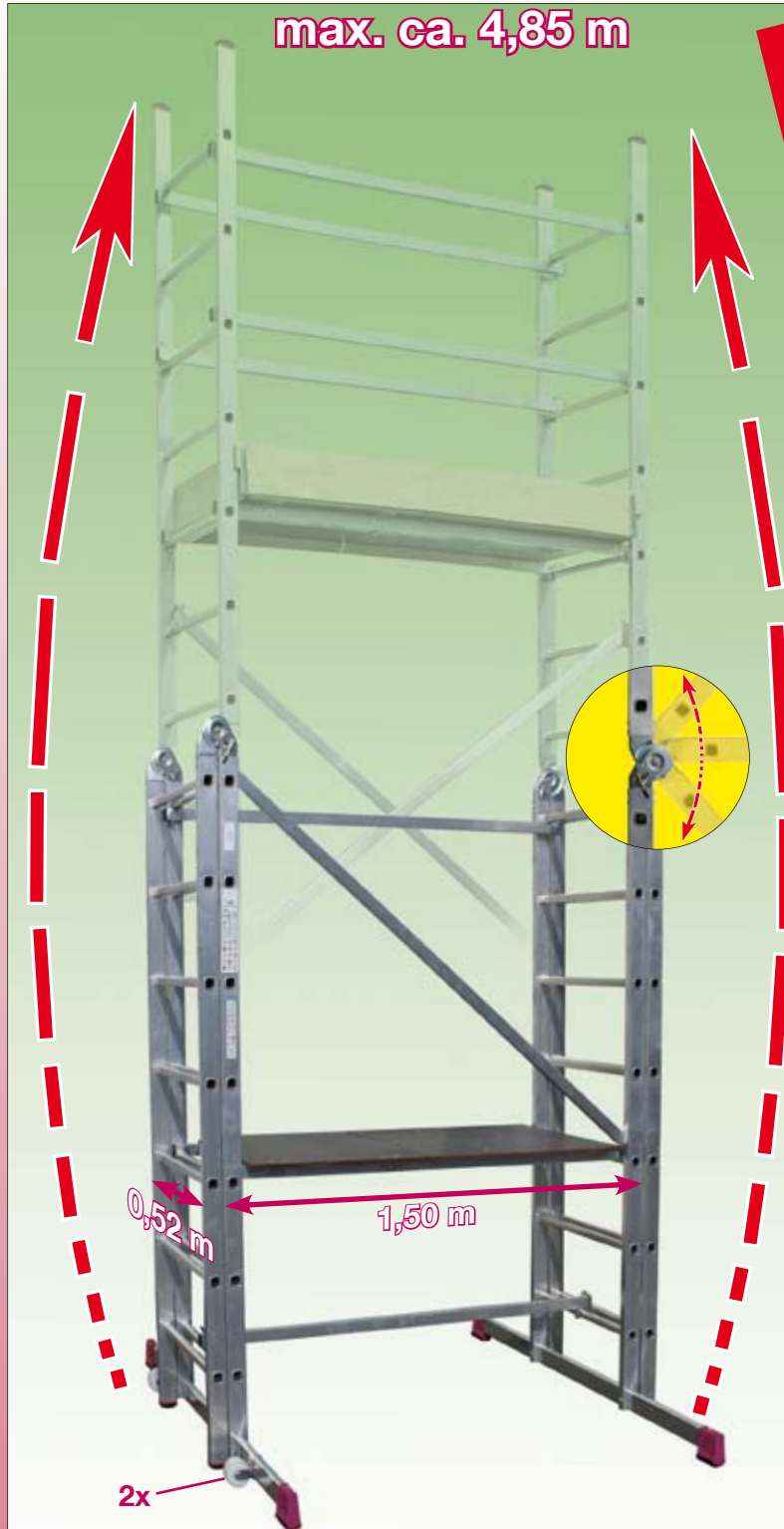

* Weitere Anwendungsmöglichkeiten
 Further application possibilities
 Inne możliwości zastosowania
 Egyéb felhasználási lehetőségek
 другие возможности использования
 Posibilidades adicionales de aplicaciones

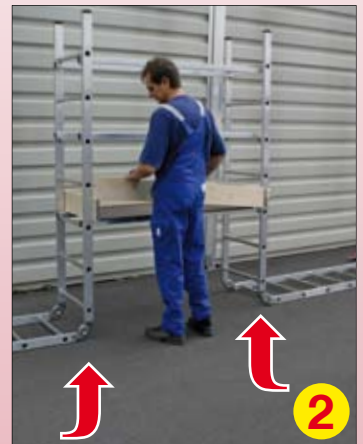

Art.-No. 916273 / 950061

ca. 50,0 kg
 EN 1004 / 150 kg/m²

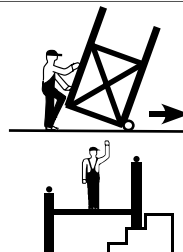
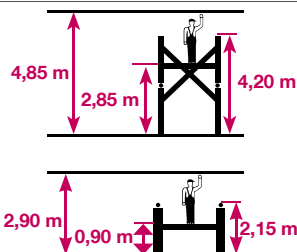
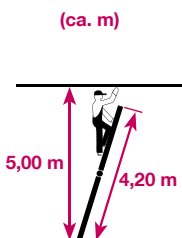
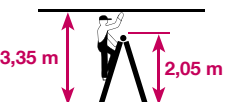

EXTRAS
 Art.-No. 704306

1

2

3

4



Heimwerkergerüst • DIYer's Scaffold • Mini ruszowanie montazowe
 Баркасалівану • передвижные подмости • Андатію брiсoлаje

Mobilgerüst • Mobile Scaffold • Ruszowanie „MOBIL”
 Мобiлiвaну • Передвiжнiе подмости • Андатію мбvii

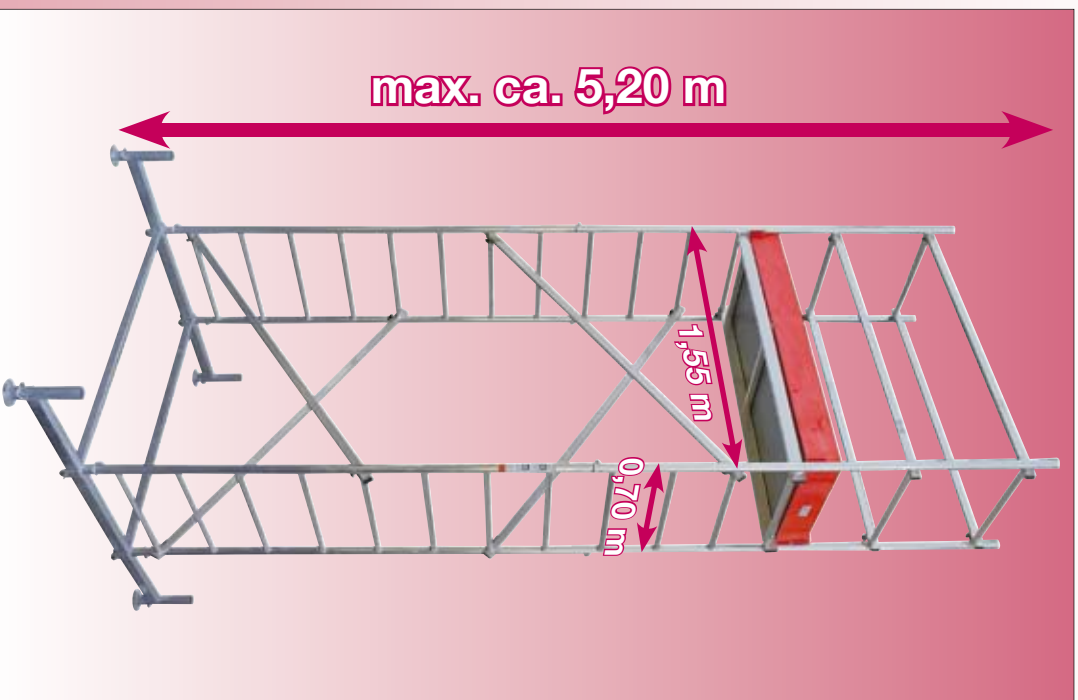
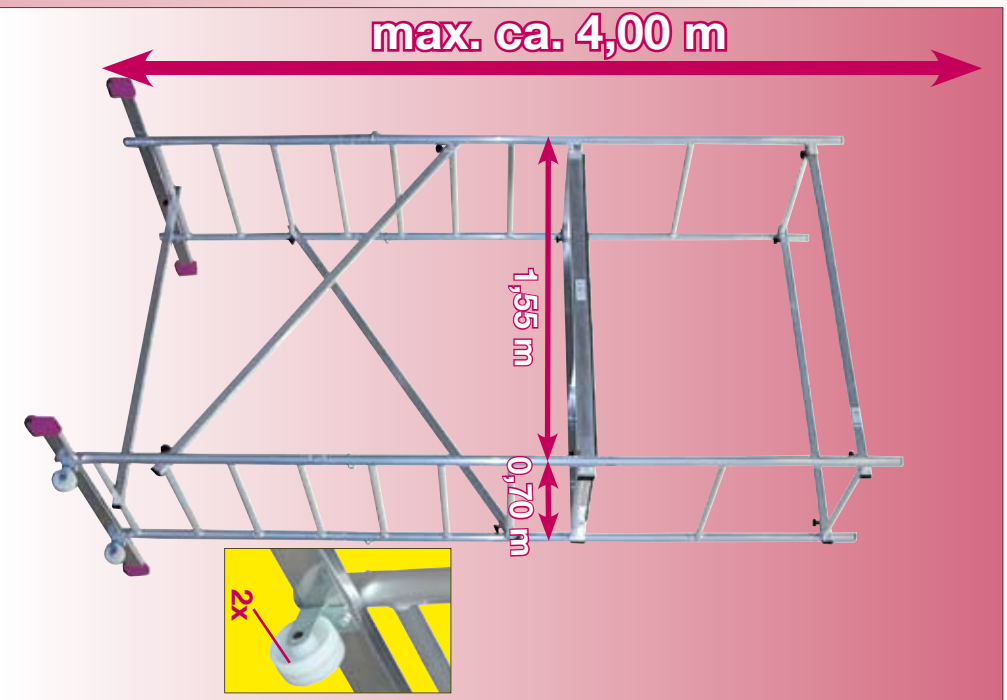

Art.-No. 916082 / 950191
 ca. 35,0 kg
 2 PFG1273 / 04.05 / 150 kg/m²

Art.-No. 916013 / 950146
 ca. 55,0 kg
 EN 1004 / 150 kg/m²

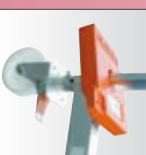
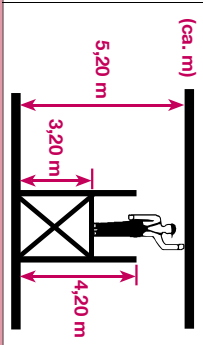
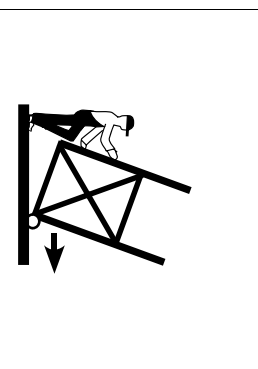
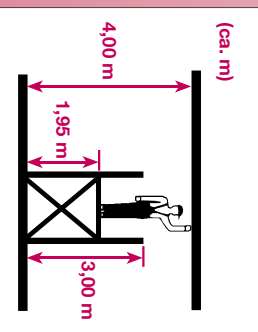

EXTRAS

ОФИЦИАЛЬНЫЙ ДИЛЕР В УКРАИНЕ:

storgom.ua

ГРАФИК РАБОТЫ:

Пн. – Пт.: с 8:30 по 18:30

Сб.: с 09:00 по 16:00

Вс.: с 10:00 по 16:00

КОНТАКТЫ:

+38 (044) 360-46-77

+38 (066) 77-395-77

+38 (097) 77-236-77

+38 (093) 360-46-77

Детальное описание товара: <https://storgom.ua/product/svobodno-stoiashchaia-stremianka-krause-corda-5.html>

Другие товары: <https://storgom.ua/stremyanki.html>